



PRODUCTS CATALOGUE
CATALOGO PRODOTTI



Refrigera: Quality and Innovation

REFRIGERA INDUSTRIALE is a manufacturing Company that operates in the business of Heating, Ventilation, Air conditioning and Refrigeration (better known by the acronym HVAC-R).

The company designs, produces and distributes "Refrigera-Linea del Freddo"® branded valves for refrigeration systems and branch joints and headers for VRF air-conditioning systems.

REFRIGERA INDUSTRIALE can count on a consolidated know-how in the design and manufacture of high quality and high innovative range of products. These competitive factors enable REFRIGERA INDUSTRIALE to sell its products in more than 40 foreign countries of four continents.

Very recently the company has launched a new R&D program named "Refrigera 4 Environment"®, to develop new products by which REFRIGERA INDUSTRIALE is committed to providing a tangible contribution to the interactions between man and climate. The purpose of this program is to promote the environmental sustainability of the HVAC-R systems made with "Refrigera-Linea del Freddo"® branded components.

Every product carries the "CE-Made in Italy" label, reflecting its conformity to ISO9001:2008 norm and to european legislation 97/23/EC (Pressure Equipment Directive).

Depending on the operating pressure, the Company's product range differs from the line as follows:

- products for Freon, suitable for a maximum working pressure up to 52 bar
- products for AMMONIA - R717, suitable for a maximum working pressure up to 37 bar
- products for CO₂ - R744 suitable for a maximum working pressure up to 75 bar
- products for CO₂ - R744 for use in trans-critical cycles and pressure up to 120 bar

in the main types:

- Full bore ball valves with DN from 6 mm to 133 mm bi-directional type, available with preloading, 2 or 3 way, with or without electric actuator.
- Safety valves for protection against over pressure, between 1/4" and 1-1/4"
- Non-return valves (check valves) with NB between 6 mm and 80 mm (3-1/8")
- Indicators and humidity sensible element, consisting of a coloured indicator which shows the value of moisture.
- Filter driers with molecular sieve filtration suitable for particles smaller than 10 microns
- Ball valves with NPT connections
- Ball valves for Turbocor™ compressors
- Flanged Valves
- 3-way changeover devices to mount two safety valves in parallel
- Rotalock Valves
- Fittings and Adapters
- Bent connecting pipes
- Piping kits, custom assembled with valves
- Collectors and distributors to finned-pack heat exchangers
- Capillary-tube exchangers
- Serpentine
- A/C Piping systems Fittings

Refrigera: Qualità ed Innovazione.

REFRIGERA INDUSTRIALE è un'azienda di produzione che opera nei campi del Riscaldamento, Ventilazione, Condizionamento e Refrigerazione (più conosciuto con l'acronimo inglese HVAC-R: Heating, Ventilation, Air-Conditioning, Refrigeration).

L'Azienda progetta, produce e distribuisce con il marchio "Refrigera-Linea del Freddo"® valvole per il settore della refrigerazione e commercializza derivazioni, collettori ed accessori per i sistemi di condizionamento VRF.

REFRIGERA INDUSTRIALE può contare su un consolidato know-how nel design e nella produzione di prodotti di elevata qualità e innovazione, che le hanno consentito di acquisire quote di mercato in oltre 40 Paesi esteri, in quattro continenti. L'Azienda ha lanciato un programma di ricerca e sviluppo di nuovi prodotti battezzato "Refrigera 4 Environment"®, con il quale si sta impegnando nell'offrire un contributo tangibile al sistema di interazione uomo-clima, per favorire la sostenibilità ambientale degli impianti realizzati con i prodotti del marchio "Refrigera-Linea del Freddo"®.

Ogni prodotto riporta l'etichetta "CE.Made in Italy", che evidenzia la conformità alle norme ISO 9001/2008 ed alla direttiva europea 97/23/CE per gli apparecchi a pressione. (Pressure Equipment Directive).

In funzione delle pressioni massime di esercizio la gamma di prodotti dell'azienda, si differenzia per linee in:

- prodotti per Freon con pressione massima di esercizio fino a 52 bar
- prodotti per AMMONIACA - R717 con pressione massima di esercizio fino a 37 bar
- prodotti per CO₂ - R744 con pressione massima di esercizio fino a 75 bar
- prodotti per CO₂ - R744 in cicli transcritici con pressione massima di esercizio fino a 120 bar

nelle seguenti tipologie:

- Valvole a Sfera a passaggio pieno con DN compreso tra 6 mm e 133 mm di tipo bi-direzionale rispetto alla direzione del flusso, disponibili con valvolina di precarica, a 2 o 3 vie, con o senza attuatore elettrico;
- Valvole di sicurezza per la protezione contro le sovrappressioni con diametro di connessione di ingresso e uscita tra 1/4" e 1-1/4"
- Valvole di non ritorno (check valves) con DN compreso tra 6 mm e 80 mm (3-1/8")
- Indicatori di liquido ed umidità costituiti da un elemento sensibile il cui colore indica il valore di umidità sulla linea
- Filtri disidratatori a setaccio molecolare con grado di filtrazione adatto a particelle di dimensioni oltre i 10 micron
- Valvole a sfera con connessioni NPT
- Valvole a sfera per compressori Turbocor™
- Valvole flangiate
- Valvole deviatrici a 3 vie per montare 2 valvole di sicurezza in parallelo
- Valvole Rotalock
- Raccordi ed Adattatori
- Derivazioni curvate per condizionamento
- Collettori e distributori per scambiatori a pacco alettato
- Scambiatori a tubi capillari
- Serpentine
- Piping Systems Fittings

REFRIGERA INDUSTRIALE SRL Società unipersonale

Capitale Soc.: € 10.000,00 i.v.

Via Chiavornico, 76 - 33084 Cordenons (PN) - ITALIA

P.IVA: IT01743590935

TEL. +39 0434 542266 - FAX +39 0434 542267

WEB: www.refrigera.eu - EMAIL: info@refrigera.eu



Innovative Technologies for Freon and trans-critical CO2 plants

Refriger® Brand of Refriger Industriale SRL Company – leader in industrial refrigeration and air conditioning – is the result of long years of hard work and experience in the field of mechanical engineering and metallurgy of the technical staff and of the close relationship with key suppliers and customers, who are continually involved whenever it is necessary to start a new project and get information back. A joint partnership with a manufacturing Company - specialized in the production of copper, inox, aluminium pipes, manifolds and headers - let Refriger Industriale SRL to get involved also in pipe working. Refriger® is synonymous with “Quality Made in Italy”, made up of hard-working employees and by an expert sales team that knows how to deliver

profitability. Our goal is to increase the business globally and achieve increasingly ambitious goals in internationalized markets. A great opportunity to extend the network of knowledge and expand existing business around the world to our current range. Currently 70% of the Company's turnover comes from exports. Markets covered are all European states, Turkey, Canada, Australia, Russia, South Africa.” Today, in a market very disoriented by the imminent deadline for the divestment of HCFC refrigerants, as a result of severe environmental global emergencies, Refriger Industriale SRL has set itself the objective to produce CO2 ball valves for trans-critical application.

The manufacture:

- products for Freon of

maximum working pressure up to 52 bar

- products for R744 of maximum working pressure up to 75bar
- R744 products to use in trans-critical cycles and pressure up to 120 bar.

Furthermore, R&D Department is able to satisfy most of the customers needs, which are closely monitored by the Engineering Department, Sales and Field Service. Many new projects are going to be launched, to continue developing ever better products.

*Refriger exports in 52 Countries Worldwide
Turkey, Canada, Australia, Russia, South Africa included*

Continuous Improvement

The air conditioning and refrigeration market is subject to continuous, progressive changes due to new European guidelines that require companies to develop alternative technologies. The main drivers of this process are linked to:

- restrictive measures taken by governments to address environmental problems associated with air emissions from air conditioning and refrigeration systems, in particular to allow the reduction of the ozone layer and avoid global warming, as established by the Kyoto Protocol
- change of consumer habits, derived from the general shift towards a high standard of quality of life;

- the latest safety and energy saving standards.

Refriger® introduces a discontinuity in the market: Up to the widest range of DN 42 mm / 1-5/8 new valves entirely made of steel mounting stainless steel or new CuFe2P alloy Connections. Refriger Industriale SRL is the first refrigeration OEM to walk this way, as to be a leading provider of systems that are widely anticipate the replacement of refrigerants with GFP (Green Footprint) greater than zero and in accordance with ISO 9001 / 2008 and European legislation 97/23/EC (Pressure Equipment Directive).



A Tee Joint made of CuFe2P copper alloy



Our Manufacturing Plant - Cordenons - Italy

QuattroWAYRefrigerera: the solution for reversing cycles

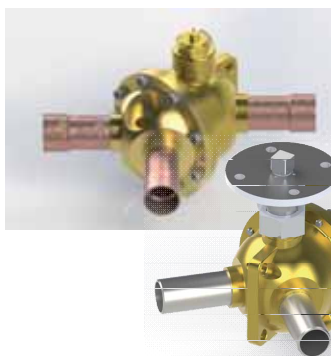

New 4Way Reversing Ball Valve

In applications such as heat pumps or reversible air conditioning units

The 4-way Reversing Valve is the key component to provide Heating and Cooling by reversing the flow direction of refrigerant. In applications such as heat pumps or reversible air conditioning units and chillers it changes from cooling mode in summer to heating mode in winter.

Valves are suitable for all P.E. Directive Group 2 refrigerants and operate under the full pressure of the heat pump system. The ball-valve design guarantees minimum pressure drop and very low risk of leakage and ensures quick changeover even without any

pressure differential. The cycle inversion needs no solenoid pilot valve and no slider movement, reducing risk of mechanical seizures. The models offer a wide range of connection sizes, configurations and capacity for specific applications. 4-way Reversing Valves are CE approved products and suitable to AISI304 connections, to install them in R744 trans-critical systems.

As an option, Refrigerera can supply the valve mounting CuFe2P tubes, with socket welding connections, for use in high pressure applications.

ISO5211 Flange, purposely burst-proof designed for heavy

duty HVAC applications, allows easy coupling to every electrical actuator model on the market. Manufactured with high quality components in flanged coupling design to allow customers to eventually operate inside the valve with maintenance and cleaning.

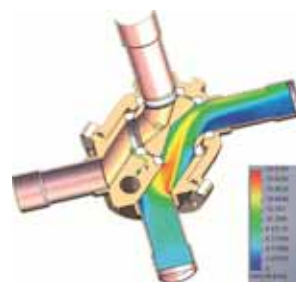

Special Assemblies



A Y-branch Joint with an Actuated Ball Valve

Refrigerera Industriale SRL has been sought for meet the demand of customers, increasingly oriented to reduce the time and the effort for manoeuvres and maintenance of the facilities, through remote controls: the numerous requests for automation by electric actuators, is forcing Refrigerera® to add a section of

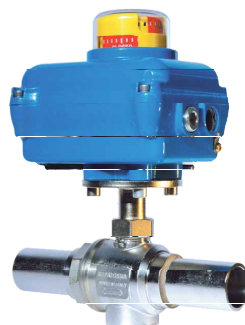

Actuated 3w Ball Valve

Refrigerera Industriale SRL records already a growing demand for components with a positive GREEN FOOTPRINT, particularly from the markets more sensitive to environmental issues, where the adoption of environmentally friendly products is encouraged through subsidies and tax breaks.

The new projects are a new challenge to promote the usage of CO₂, also witnessed by the constant involvement (now as a Silver Partner) in www.R744.com website, the largest community of CO₂ commercial and industrial refrigeration manufacturers. At last, this new range of products suitable for trans-critical-cycles, has been engaged the technical staff to become more rigorous in monitoring leaks and increase the burst tests to reach the class II PED conformity declaration by an important Italian provider.

All products in all available diameters will be displayed to the next World Trade Fair in

the catalogue for 2 way, 3way actuated valves. The Connection Kit shows an ISO-5211 flange, customized for every Refrigerera valve and allows to couple them with the entire range of motors on the market. On Refrigerera stock are also available On-Off or Step-Motor Electric Actuators. Models are suitable both for AC or DC supply.

which Refrigerera is an active supporter and especially:

EXPOCOMFORT – Italia.

CHILLVENTA – Deutschland & Rossija.

HVAC&R Japan.

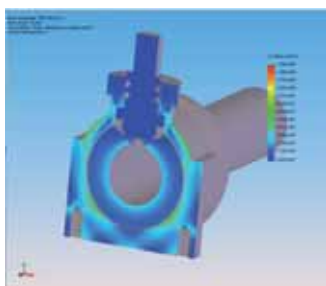

Quality Controls



Inside air-tight control on ball valves by gas mass-sensor measurements

Traceability and periodic inspection of Notified Body definitely guarantee the highest level of quality

Refrigeria Industriale SRL takes care of the quality of its products. 100% of manufacturing components are checked against



leakages through strict procedures conducted by ad-hoc instructed personnel, who execute airpressure tests to every single valve inside 4 pressure-test chambers and by direct inspection or by automatic sensors provide to evaluate the perfect airtight of them, one by one. Suppliers are deeply involved into quality assurance by compiling, for

each lot of production, control charts and executing capability inspections under direct surveying of Refrigeria Quality Management. In order to assure that the outsourcing processes maintain the high standard of quality, each supplier is evaluated annually regarding its quality level and punctuality of its supplies. Traceability of casted brass and periodic inspection of a third party Notified Body accredited Accredia (Italian Accreditation Body), definitely guarantee customers to the respect of all the procedures adopted by 93/27/EC – Pressure Equipment Directive.

Quality system adopted by Refrigeria SRL complies with the UNI EN ISO 9001:2008 rules and refers to operating instructions continually up to date in order to keep high safety level of each part subject to pressure, specially for high pressure valves and ammonia suitable products. Valves are designed for all P.E. Directive Group 2 refrigerants and operate under the full pressure of the heat pump system.



Outsourcing Monitoring



High pressure valves inspection-chamber

Refrigeria Industriale SRL carefully proceed to keep monitored incoming materials through calibrated instruments in order to prevent non conform raw materials going inside to manufacturing cycles. On the other hand, Refrigeria keeps under strict control outsourcing supplies,



Dimensional controls

reporting dimensions charts to analyze quality of tooling machinery and to keep constant assembly dimensions to size perfectly testing tools. Periodically Refrigeria Industriale SRL executes burst test to validate new components or check incoming materials.

New range of products has been engaged the technical staff to become more rigorous to execute limit-state calculation and in monitoring the strength limits of the materials. and this will be as the more important as it will allow us to reach the class II PED-conformity for the big DN 40 AISI304 high pressure ball



Calibrated manometers check test machines

valve and to implement American UL approvals to R744 valves to reach USA markets. Recently TIG Soldering was adopted instead of brazing to connect stainless steel tubes to the valves. It has dramatically increased the endurance of components to withstand at the highest working pressure. It allows Refrigeria to improve the safety of its top level products. Accurate measurements of dimensions, pressure, weight are required in a wide range of applications, where they are critical in decisions relating to human health and

safety. At this purpose, Refrigeria Periodically all the measure instruments are subjected to calibration at authorized centres in the course of a technical collaboration agreement, with respect to the current regulations without compromising the continuity of the activities. calibration centre has been Accredia accredited.



Outside air-tight inspection controls

ENCODING KEY

Refrigera Products' Code state clearly the main characteristics of the item which is referred to. Here's the key to help you to better understand it for the most important range of products.

| Ball Valve | | | | | | | |
|----------------------------|-----------------|---|---------------------------------|--|---|-------------------------------------|--|
| Products Line | Sphere Turning | Tipo di refrigeranti Idonei (materiali, guarnizioni, o-ring, seggi) Media Suitable (materials, gaskets, o-ring, seats) | Access Port | Port Diameter | ODS Size | metric/inch Tubing | Special mounting |
| Linea Prodotti | Rotazione sfera | | Presenza dispositivo Pre carica | Passaggio Sfera | Diametro connessione a saldare | Connessioni millimetri /pollici | Caratteristiche speciali |
| REF | 1 | .0 | .N | .A | .006 | .1 | .M |
| Meaning Varianti Possibili | | | | | | | |
| REF=Solder conn | 0= 180° Turn | 0=Freon | N= no access port | A=10mm; B=15mm; C, J, K=19mm; D=25mm; E, W, X=32mm; F=40mm; G=50mm; H=65mm; L=80 mm; M=100mm | 006, 008, 010, 012, 016, 018, 022, 028, 035, 042, 054, 064, 067, 076, 080, 089, 092, 105, 108, 115, 127 | 1=metric 2=inch 3=metric&inch | M=three Way P=Fit for Motor N=NPT T=Sealed 52= 52bar 120=120bar |
| LOK=Rapid conn | 1= 90° Turn | 1= R744 | S= access port mounted | | | | |

| Check Valve | | | | | | |
|----------------------------|--|------------|--|---------------------------------|---------------|--|
| Products Line | Tipo di refrigeranti Idonei (materiali, guarnizioni, o-ring + seggi) | Spring | ODS Size | metric/inch Tubing | | |
| Linea Prodotti | | Tipo Molla | Diametro connessione a saldare | Connessioni millimetri /pollici | | |
| REF | 3 | .0 | .N | .006 | .1 | |
| Meaning Varianti Possibili | | | | | | |
| REF=Solder conn | 3= Check Valves | 0=Freon | S=reinforced spring 0,3 bar pressure differential N=standard spring 0,1 bar pressure differential | 006, 008, 010, | 1=metric | |
| LOK=Rapid conn | | 1= R744 | | 012, 016, 018, | 2=inch | |
| | | | | 022, 028, 035, | 3=metric&inch | |
| | | | | 042, 054, 064, | | |
| | | | | 067, 076, 080, | | |
| | | | 089, 092, 105, | | | |
| | | | 108, 115, 127 | | | |

ENCODING KEY

Each products-range has a different identifying Code because of its peculiar properties.

| Rotalock Valve | | | | |
|-------------------------------|--|---|--|--|
| Products Line | | Rotalock Nut Size | Body Size | ODS Size |
| Linea Prodotti | | Dimensione Dado Rotalock | Dimensioni Corpo Valvola | Diametro connessione a saldare |
| REF | 22 | .42 | .20 | .006 |
| Meaning Varianti Possibili | | | | |
| REF | 22= Brass Valve/Copper connections; 24= Steel Valve; 32= Brass Straight Adapter / Copper Conn. 34= Steel Straight Adapter; 42= Brass Angle Adapter / Copper Conn. 44= Steel Angle Adapter | 41=3/4" 42=1" 43=1-1/4" 44=1-3/4" 45=2-1/4" | N=standard 20= 20mm 22= 22mm 30= 30mm 35= 35mm 50= 50mm | 006, 014, 008, 010, 038, 012, 127, 016,018, 034, 022, 028, 118, 035, 042 158, 054 |

| Sight Glass | | | | |
|-----------------------------------|--------------|------------------------|--|--|
| Products Line | | Media | Connection type | Connection size |
| Linea Prodotti | | Tipo di gas supportati | Tipo di Connessione | Diametro connessione |
| REF | 60 | .00 | .01 | .014 |
| Meaning Varianti Possibili | | | | |
| REF=Solder conn LOK=Rapid conn | 60=Indicator | 00=Freon 61=R744 HP | 00=no connections mounted 01=ODS Inlet+ODS outlet 02= SAemale Inlet+SAemale outlet 03= ODS Inlet+SAemale outlet 04= SAemale Inlet+SAFemiale outlet | 006, 014, 008, 010, 038, 012, 127, 016,018, 034, 022, 028, 118, 035, 042 158, 054 |

ENCODING KEY

In every case, if you have not been able to find the code, Refrigera Industriale Sales Assistant will help you to choose the right product through the peculiar properties you are asking for.

| Filter Drier | | | | |
|-------------------------------|--|---------------------|---------------------------------|----------------|
| Products Line | Volume Code | Connection type | Connection size | |
| Linea Prodotti | Codice dimensionale | Tipo di Connessione | Diametro Connessione | |
| REF | 70 | .052 | .01 | .006 |
| Meaning Varianti Possibili | | | | |
| REF=Solder conn | 70=Freon Filter | 048-StandardCode | 00=no connections mounted | 006, 014, 008, |
| LOK=Rapid conn | 71=Freon Biflow Filter | 052 | 01=ODSinlet+ODSoutlet | 010, 038, 012, |
| | 72=Freon Biflow Filter Solid Cartridge | 053 | 02=SAEmale inlet+SAEmale outlet | 127, 016,018, |
| | | 083 | 03=ODSinlet+SAEmale outlet | 034, 022, 078, |
| | 73=R744 HP Filter | 084 | 04=SAEmale inlet+SAEmale outlet | 028, 118, 035, |
| | | 085 | | 042, 158, 054, |
| | | 096 | | 218, 258 |
| | 75=R744 Filter | 144 | | |
| | | 163 | | |
| | 76=R744 Biflow Filter | 164 | | |
| | | 165 | | |
| | 77=R744 Biflow Filter Solid Cartridge | 304 | | |
| | | 305 | | |

| Safety Valve | | | | | | |
|-------------------------------|--------------------|------------------|--------------------|-------------------|-------------------|------------------|
| Products Line | Attacco di entrata | Inlet Connection | Attacco di scarico | Outlet Connection | Ø FlowSection | Setting Pressure |
| Linea Prodotti | | | | | Diametro Orificio | Pressione di Set |
| REF | 80 | .38 | .34 | .10 | .075 | |
| Meaning Varianti Possibili | | | | | | |
| REF | 80= Safety Valves | 38=3/8"NPT | 00=FREE | 10= 10mm | 0 ÷ 60 bar | |
| | | 14=1/4"NPT | 12=1/2"GAS | 14= 14mm | 61 ÷ 100 bar | |
| | | 12=1/2"NPT | 34=3/4"GAS | | 100 ÷ 150 bar | |
| | | 34=3/4"NPT | 01=1"GAS | | | |
| | | 01=1"NPT | 11=1 1/4"GAS | | | |
| | | 11=1 1/4"NPT | 17=1 1/2"GAS | | | |
| | | 17=1 1/2"NPT | | | | |

CONTENTS

Products suitable for systems using Fluorocarbons as refrigerant

| | | |
|------------------|----------------------------|----|
| MWP 52BAR | BALL VALVES | 7 |
| | CHECK VALVES | 17 |
| | 3 WAY CHANGEOVER VALVES | 18 |
| | SAFETY VALVES | 20 |
| | ROTALOCK VALVES + FITTINGS | 22 |
| | FILTER DRIERS | 28 |
| | SIGHT GLASSES | 32 |
| | SOLENOID VALVES | 32 |

Products suitable for systems using R744 as refrigerant to work in subcritical cycle

| | | |
|------------------|-------------------------|----|
| MWP 52BAR | BALL VALVES | 34 |
| | CHECK VALVES | 42 |
| | 3 WAY CHANGEOVER VALVES | 44 |
| | BI FLOW FILTER DRIERS | 45 |

Products suitable for systems using R744 as refrigerant to work in transcritical cycle

| | | |
|-------------------|-------------------------|----|
| MWP 120BAR | BALL VALVES | 46 |
| | CHECK VALVES | 53 |
| | 3 WAY CHANGEOVER VALVES | 54 |
| | SAFETY VALVES | 56 |
| | SIGHT GLASSES | 57 |
| | AISI304 VALVES | 58 |

Products suitable for systems using R744 in transcritical cycle and mount CuFe2P pipings

| | | |
|-------------------|---------------|----|
| MWP 120BAR | BALL VALVES | 65 |
| | CHECK VALVES | 72 |
| | SIGHT GLASSES | 74 |
| | PIPING | 75 |

Accessories and fittings

| | | |
|--------------------|--------------------|-----|
| Spare Parts | INSULATING SLEEVES | 78 |
| | CONNECTION KIT | 79 |
| | ROTARY ACTUATORS | 80 |
| | FITTINGS | 82a |





 Our bi-flow system allows the mounting of the valve without taking into consideration the direction of the flow. The small equalization hole on the sphere will allow the valve to support the gas pressure without stressing other components. Full and reduced port available for diameters 64mm up to 3-1/8" (80mm). 4-1/8", 5" valves are entirely made of steel.

 Il brevettato sistema bidirezionale permette di montare la valvola indipendentemente dalla direzione del flusso. Il piccolo foro sulla sfera fa sì che la valvola possa sopportare la pressione del gas senza sollecitare i seggi di tenuta. Disponibili versioni a passaggio pieno e a passaggio ridotto per diametri da 64mm fino a 80mm (3-1/8"). I diametri da 105 a 127 mm sono realizzati interamente in acciaio.

 Das patentierte BiFlow-System ermöglicht die Montage des Ventils unabhängig von der Strömungsrichtung. Die kleine Bohrung auf der Kugel sorgt dafür, dass das Ventil der Gasdruck aushält ohne die Dichtungssitze zu belasten. Die Versionen sind mit vollem oder reduziertem Durchlauf für Durchmesser von 64 mm bis 80 mm (3-1/8") lieferbar. Die Durchmesser von 105 bis 127 mm sind ganz aus Stahl gefertigt.

 Notre système bi-directionnel permet d'installer la vanne sans se préoccuper de la direction du flux. Le petit trou permet à la vanne de supporter la pression du gaz utilisée sans trop solliciter les autres composants. Les versions pour les passages pleins ou réduits sont disponibles de 64 mm à 80 mm (3-1/8"). Les diamètres de 105 à 127 mm sont réalisés entièrement en acier.

 El sistema bidireccional patentado permite montar la válvula independientemente de la dirección del flujo. El pequeño orificio sobre la esfera hace que la válvula pueda soportar la presión del gas sin presionar los asientos de contención. Disponibles las versiones de pasaje completo o reducido para diámetros desde 64mm hasta 80mm (3-1/8"). Los diámetros desde 105 hasta 127mm son realizados enteramente en acero.

 O sistema bidireccional patentado permite de montar a válvula independentemente da direção do fluxo. O pequeno orificio sobre a esfera faz com a válvula possa suportar a pressão do gás sem forçar as vedações. Disponíveis nas versões de passagem plena e de passagem reduzida para diâmetros de 64 mm até 80 mm (3-1/8"). As válvulas com diâmetros de 105 a 127 mm são fabricadas inteiramente de aço.

 弊社バイ・フロー・システムは、フローの方向を考慮に入れないバルブのマウンティングを可能にします。スフィア上の小さいイコライゼーション・ホールは、他のコンポーネントをストレスさせることなく、バルブがガス・プレッシャーをサポートすることを、可能にします。直径64ミリから最大3インチ1/8（80ミリ）において、フル、およびリデュースポートが、入手可能です。4インチ1/8、および5インチバルブは、全体がスチールで作られています。

 Наша двунаправленная система позволяет монтировать клапан без учёта направления потока. Небольшое отверстие на шаре позволяет клапану выдерживать давление газа без нагрузки на остальной материал. Имеются клапаны для полного прохождения и для уменьшенного прохождения диаметром от 64мм до 80 мм (3-1/8"). Клапаны 105-127 мм изготавливаются из стали.

Ball Valve

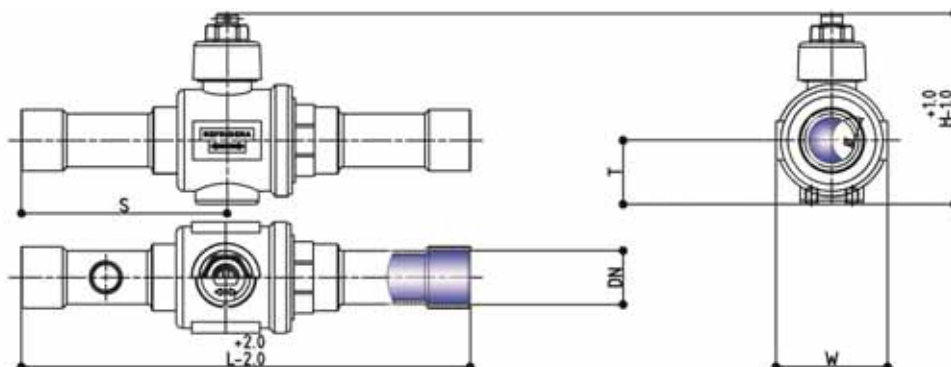
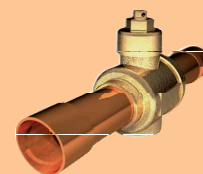



| Code | Connection | Weight | Sphere passage | Length | Height | Wide | S | T | Kv | PS | WTemp | P.E.D. |
|---------------------|--------------|--------|----------------|--------|--------|--------|--------|--------|----------------|-----|----------|---------------|
| REF | ODS | (g) | Ø (mm) | L (mm) | H (mm) | W (mm) | S (mm) | T (mm) | ΔP:1bar (m³/h) | bar | °C | Group2 fluids |
| REF1.0.N.A.006.1 | 6mm | 110 | 8 | 126 | 40 | 24 | 60 | 12 | 1,0 | 52 | | Art.3.3 |
| REF1.0.N.A.006.2 | 1/4" | 110 | 8 | 126 | 40 | 24 | 60 | 12 | 1,0 | 52 | | Art.3.3 |
| REF1.0.N.A.008.3 | 8mm 5/16" | 110 | 8 | 126 | 40 | 24 | 60 | 12 | 1,0 | 52 | | Art.3.3 |
| REF1.0.N.A.010.1 | 10mm | 110 | 8 | 132 | 40 | 24 | 63 | 12 | 2,4 | 52 | | Art.3.3 |
| REF1.0.N.A.010.2 | 3/8" | 110 | 8 | 132 | 40 | 24 | 63 | 12 | 2,4 | 52 | | Art.3.3 |
| REF1.0.N.A.012.1 | 12mm | 120 | 8 | 140 | 40 | 24 | 67 | 12 | 2,7 | 52 | | Art.3.3 |
| REF1.0.N.A.012.2 | 1/2" | 120 | 8 | 140 | 40 | 24 | 67 | 12 | 2,7 | 52 | | Art.3.3 |
| REF1.0.N.B.015.1 | 15mm | 350 | 15 | 145 | 60 | 34 | 68 | 17 | 12,5 | 52 | | Art.3.3 |
| REF1.0.N.B.016.3 | 16mm 5/8" | 350 | 15 | 145 | 60 | 34 | 68 | 17 | 13 | 52 | | Art.3.3 |
| REF1.0.N.B.018.1 | 18mm | 350 | 15 | 145 | 60 | 34 | 68 | 17 | 14 | 52 | | Art.3.3 |
| REF1.0.N.B.018.2 | 3/4" | 350 | 15 | 145 | 60 | 34 | 68 | 17 | 14 | 52 | | Art.3.3 |
| REF1.0.N.C.022.3 | 22mm 7/8" | 720 | 19 | 185 | 80 | 46 | 85 | 26 | 24 | 52 | | Art.3.3 |
| REF1.0.N.D.028.1 | 28mm | 750 | 25 | 185 | 85 | 51 | 90 | 28 | 40 | 52 | | Art.3.3 |
| REF1.0.N.D.028.2 | 1-1/8" | 750 | 25 | 185 | 85 | 51 | 90 | 28 | 40 | 52 | | Art.3.3 |
| REF1.0.N.E.035.3 | 35mm 1-3/8" | 1370 | 32 | 205 | 105 | 66 | 95 | 35 | 67,3 | 52 | -40/+150 | Class I |
| REF1.0.N.F.042.1 | 42mm | 2440 | 40 | 230 | 125 | 76 | 115 | 48 | 98 | 52 | | Class I |
| REF1.0.N.F.042.2 | 1-5/8" | 2440 | 40 | 230 | 125 | 76 | 115 | 48 | 98 | 52 | | Class I |
| REF1.0.N.G.054.3 | 54mm 2-1/8" | 3360 | 50 | 285 | 130 | 90 | 133 | 45 | 190 | 52 | | Class I |
| REF1.0.N.G.064.1 | 64mm | 3450 | 50 | 286 | 130 | 90 | 140 | 45 | 200 | 45 | | Class I |
| REF1.0.N.G.067.2 | 2-5/8" | 3450 | 50 | 286 | 130 | 90 | 140 | 45 | 210 | 45 | | Class I |
| REF1.0.N.H.064.1 | 64mm | 8350 | 65 | 355 | 170 | 118 | 170 | 70 | 360 | 45 | | Class I |
| REF1.0.N.H.067.2 | 2-5/8" | 8350 | 65 | 355 | 170 | 118 | 170 | 70 | 370 | 45 | | Class I |
| REF1.0.N.H.076.3 | 76mm 3" | 8430 | 65 | 355 | 170 | 118 | 170 | 70 | 380 | 45 | | Class I |
| REF1.0.N.H.080.3 | 80mm 3-1/8" | 8430 | 65 | 355 | 170 | 118 | 170 | 70 | 390 | 45 | | Class I |
| REF1.0.N.L.080.3 | 80mm 3-1/8" | 11800 | 80 | 385 | 185 | 150 | 190 | 77 | 500 | 40 | | Class I |
| REF1.0.N.L.089.3 | 89mm 3-1/2" | 11800 | 80 | 385 | 185 | 150 | 190 | 77 | 520 | 40 | | Class I |
| REF1.0.N.L.092.2 | 3-5/8" | 11930 | 80 | 390 | 185 | 150 | 190 | 77 | 535 | 40 | | Class I |
| REF1.0.N.L.105.3 | 105mm 4-1/8" | 12355 | 80 | 380 | 185 | 150 | 185 | 77 | 570 | 40 | | Class I |
| REF1.0.N.L.108.3 | 108mm 4-1/4" | 12355 | 80 | 380 | 185 | 150 | 185 | 77 | 575 | 40 | | Class I |
| REF1.0.N.M.115.3.AA | 115mm 106mm | 15360 | 100 | 325 | 220 | 173 | 155 | 100 | 860 | 32 | | Class I |
| REF1.0.N.M.127.3.AA | 127mm 119mm | 15360 | 100 | 325 | 220 | 173 | 155 | 100 | 880 | 32 | | Class I |

 Our bi-flow system allows the mounting of the valve without taking into consideration the direction of the flow. Valves with access port are available. Up to diameter 3/4", schraeder port is forged together with the valve-body.

 Il brevettato sistema bidirezionale permette di montare la valvola indipendentemente dalla direzione del flusso. Sono disponibili anche con la valvolina di precarica. Nei diametri fino ai 3/4" è fornita già stampata assieme con il corpo valvola.

 Das patentierte BiFlow-System ermöglicht die Montage des Ventils unabhängig von der Strömungsrichtung. Sie sind auch mit Vorfüllventil lieferbar. Bei den Durchmessern bis 3/4" wird es bereits zusammen mit dem Ventilkörper gegossen, geliefert.

 Notre système bi-directionnel permet d'installer la vanne sans se préoccuper de la direction du flux. Sont également disponibles avec la vanne de précharge. Elle est d'emblée intégrée dans le corps de la vanne pour les diamètres jusque 3/4".

 El sistema bidireccional patentado permite montar la válvula independientemente de la dirección del flujo. Están disponibles también aquellas con puerto de acceso. Para los diámetros de hasta 3/4" viene ya ensamblada al cuerpo de la válvula.

 O sistema bidirecional patenteado permite de montar a válvula independentemente da direção do fluxo. Também são disponíveis com válvula de pré-carga. As válvulas com diâmetros até 3/4" são fornecidas forjadas no corpo da válvula.

 弊社バイ・フロー・システムは、フローの方向を考慮に入れないバルブのマウンティングを可能にします。アクセス・ポートを伴うバルブが入手可能です。最大直径3/4インチであり、シュレーダー・ポートが、バルブ・ボディにフォージ結合されています。

 Наша двунаправленная система позволяет монтировать клапан без учёта направления потока. Также имеются клапаны с вентилем предварительной загрузки уже поставленным в тело, размером до 3/4".

Schrader™—Port Ball Valve

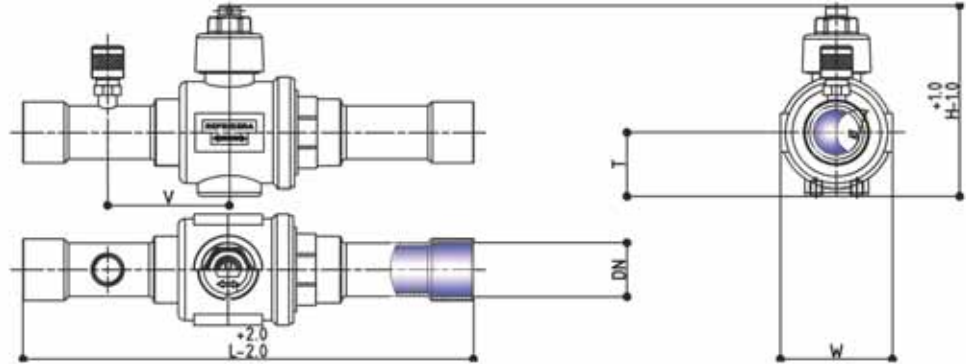
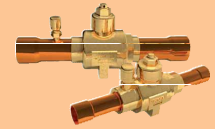



| Code | Connection | Weight | Sphere passage | Length | Height | Wide | V | T | Kv | PS | WTTemp | P.E.D. |
|------------------|--------------|--------|----------------|--------|--------|--------|--------|--------|----------------|-----|-----------|---------------|
| REF | DN | (g) | Ø (mm) | L (mm) | H (mm) | W (mm) | V (mm) | T (mm) | ΔP:1bar (m³/h) | bar | °C | Group2 fluids |
| REF1.0.S.A.006.1 | 6mm | 290 | 10 | 126 | 55 | 33 | 25 | 15 | 1,0 | 52 | | Art.3.3 |
| REF1.0.S.A.006.2 | 1/4" | 290 | 10 | 126 | 55 | 33 | 25 | 15 | 1,0 | 52 | | Art.3.3 |
| REF1.0.S.A.008.3 | 8mm 5/16" | 290 | 10 | 132 | 55 | 33 | 25 | 15 | 1,0 | 52 | | Art.3.3 |
| REF1.0.S.A.010.1 | 10mm | 290 | 10 | 132 | 55 | 33 | 25 | 15 | 2,4 | 52 | | Art.3.3 |
| REF1.0.S.A.010.2 | 3/8" | 290 | 10 | 132 | 55 | 33 | 25 | 15 | 2,4 | 52 | | Art.3.3 |
| REF1.0.S.A.012.1 | 12mm | 290 | 10 | 140 | 55 | 33 | 25 | 15 | 2,7 | 52 | | Art.3.3 |
| REF1.0.S.A.012.2 | 1/2" | 290 | 10 | 140 | 55 | 33 | 25 | 15 | 2,7 | 52 | | Art.3.3 |
| REF1.0.S.B.015.1 | 15mm | 390 | 15 | 153 | 60 | 34 | 24 | 17 | 12,5 | 52 | | Art.3.3 |
| REF1.0.S.B.016.3 | 16mm 5/8" | 390 | 15 | 153 | 60 | 34 | 24 | 17 | 13 | 52 | | Art.3.3 |
| REF1.0.S.B.018.1 | 18mm | 390 | 15 | 153 | 60 | 34 | 24 | 17 | 14 | 52 | | Art.3.3 |
| REF1.0.S.B.018.2 | 3/4" | 390 | 15 | 153 | 60 | 34 | 24 | 17 | 14 | 52 | | Art.3.3 |
| REF1.0.S.C.022.3 | 22mm 7/8" | 730 | 19 | 185 | 80 | 46 | 52 | 26 | 24 | 52 | | Art.3.3 |
| REF1.0.S.D.028.1 | 28mm | 760 | 25 | 185 | 85 | 51 | 54 | 28 | 40 | 52 | | Art.3.3 |
| REF1.0.S.D.028.2 | 1-1/8" | 760 | 25 | 185 | 85 | 51 | 54 | 28 | 40 | 52 | | Art.3.3 |
| REF1.0.S.E.035.3 | 35mm 1-3/8" | 1380 | 32 | 205 | 105 | 66 | 56 | 35 | 67,3 | 52 | -40/ +150 | Class I |
| REF1.0.S.F.042.1 | 42mm | 2450 | 40 | 240 | 123 | 76 | 68 | 48 | 98 | 52 | | Class I |
| REF1.0.S.F.042.2 | 1-5/8" | 2450 | 40 | 240 | 123 | 76 | 68 | 48 | 98 | 52 | | Class I |
| REF1.0.S.G.054.3 | 54mm 2-1/8" | 3410 | 50 | 270 | 130 | 90 | 80 | 45 | 190 | 52 | | Class I |
| REF1.0.S.G.064.1 | 64mm | 3470 | 50 | 286 | 130 | 90 | 80 | 45 | 200 | 45 | | Class I |
| REF1.0.S.G.067.2 | 2-5/8" | 3470 | 50 | 286 | 130 | 90 | 80 | 45 | 210 | 45 | | Class I |
| REF1.0.S.H.064.1 | 64mm | 8360 | 65 | 355 | 170 | 118 | 135 | 70 | 360 | 40 | | Class I |
| REF1.0.S.H.067.2 | 2-5/8" | 8360 | 65 | 355 | 170 | 118 | 135 | 70 | 370 | 40 | | Class I |
| REF1.0.S.H.076.3 | 76mm 3" | 8450 | 65 | 355 | 170 | 118 | 135 | 70 | 380 | 40 | | Class I |
| REF1.0.S.H.080.3 | 80mm 3-1/8" | 8450 | 65 | 350 | 170 | 118 | 135 | 70 | 390 | 40 | | Class I |
| REF1.0.S.L.080.3 | 80mm 3-1/8" | 11809 | 80 | 385 | 185 | 150 | 120 | 77 | 500 | 40 | | Class I |
| REF1.0.S.L.089.3 | 89mm 3-1/2" | 11809 | 80 | 385 | 185 | 150 | 120 | 77 | 520 | 40 | | Class I |
| REF1.0.S.L.092.2 | 3-5/8" | 11940 | 80 | 390 | 185 | 150 | 120 | 77 | 535 | 40 | | Class I |
| REF1.0.S.L.105.3 | 105mm 4-1/8" | 12365 | 80 | 380 | 185 | 150 | 120 | 77 | 570 | 40 | | Class I |
| REF1.0.S.L.108.3 | 108mm 4-1/4" | 12365 | 80 | 380 | 185 | 150 | 120 | 77 | 575 | 40 | | Class I |

 Incoming capacity comes from the vertical Tube (always open) and valve allows you to redirect the flow either along one of the two horizontal output directions. Full and reduced port available for diameters 64mm up to 3-1/8" (80mm). 4-1/8", 5" valves are entirely made of steel.

 La capacità in entrata proviene dal tubo verticale (sempre aperto) e la valvola consente di reindirizzare il flusso orizzontalmente lungo una delle due sezioni di scarico. Disponibili versioni a passaggio pieno e a passaggio ridotto per diametri da 64mm fino a 80mm (3-1/8"). I diametri da 105 a 127 mm sono realizzati interamente in acciaio.

 Die Eintrittskapazität wird durch das vertikale Rohr (immer offen) gegeben, das Ventil ermöglicht den horizontalen Durchfluss entlang einem der zwei Ablaufbereiche weiterzuleiten. Die Versionen sind mit vollem oder reduziertem Durchlauf für Durchmesser von 64 mm bis 80 mm (3-1/8") lieferbar. Die Durchmesser von 105 bis 127 mm sind ganz aus Stahl gefertigt.

 La capacité est transportée par le conduit vertical (toujours ouvert) et la vanne permet de rediriger le flux le long d'une des deux sections horizontales d'échappement. Tailles pour "passage intégral" et pour "passage réduit" disponibles de 64mm jusqu'à 80mm (3-1/8"). Celles en diamètres de 105 à 127 mm sont entièrement fabriqués en acier.

 La capacidad de entrada proviene del tubo vertical (siempre abierto) y la válvula permite redireccionar el flujo horizontalmente a lo largo de una de las dos secciones de descarga. Disponibles las versiones de pasaje completo o reducido para diámetros desde 64mm hasta 80mm (3-1/8"). Los diámetros desde 105 hasta 127mm son realizados enteramente en acero.

 O fluxo de entrada é proveniente do tubo vertical (sempre aberto) e a válvula permite redireccionar o fluxo horizontal ao longo de uma das duas seções de descarga. Disponíveis nas versões de passagem plena e de passagem reduzida para diâmetros de 64 mm até 80 mm (3-1/8"). As válvulas com diâmetros de 105 a 127 mm são fabricadas inteiramente de aço.

 入来キャパシティーは、垂直チューブより浸入します（常時開口）。バルブにより、フローをふたつの水平アウトプットのうちのどちらかひとつに沿うように、変更することが可能です。直径64ミリから最大3インチ1/8（80ミリ）に対し、フル、およびリデュース・ポートが入手可能です。4インチ1/8、および5インチバルブは、全体が、スチールで作られています。

 Поток поступает из вертикальной трубы (всегда открытая) и клапан позволяет направить его вдоль одной из двух горизонтально расположенных труб. Имеются клапаны для полного прохождения и для уменьшенного прохождения диаметром от 64mm до 80 mm (3-1/8"). Клапаны 105-127 mm изготавливаются из стали

3Way Ball Valve

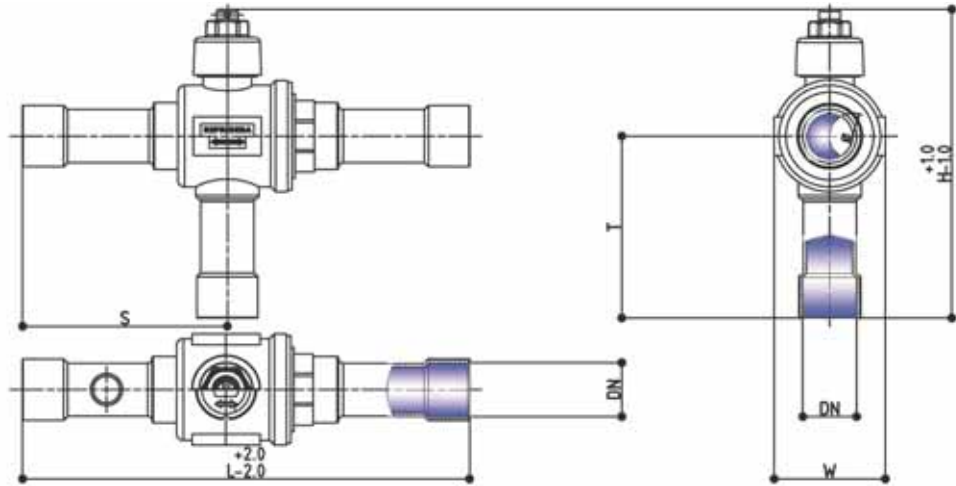
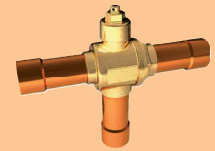



| Code | Connection | Weight | Sphere passage | Length | Height | Wide | S | T | Kv | PS | WTemp | P.E.D. |
|--------------------|-------------|--------|----------------|--------|--------|--------|--------|--------|----------------|-----|-----------|---------------|
| REF | DN | (g) | Ø(mm) | L (mm) | H (mm) | W (mm) | S (mm) | T (mm) | ΔP:1bar (m³/h) | bar | °C | Group2 fluids |
| REF1.0.N.B.015.1.M | 15mm | 360 | 15 | 148 | 109 | 34 | 68 | 61 | 5,5 | 52 | | Art.3.3 |
| REF1.0.N.B.016.3.M | 16mm 5/8" | 360 | 15 | 148 | 109 | 34 | 68 | 61 | 5,6 | 52 | | Art.3.3 |
| REF1.0.N.B.018.1.M | 18mm | 360 | 15 | 148 | 109 | 34 | 68 | 61 | 5,8 | 52 | | Art.3.3 |
| REF1.0.N.B.018.2.M | 3/4" | 360 | 15 | 148 | 109 | 34 | 68 | 61 | 5,8 | 52 | | Art.3.3 |
| REF1.0.N.C.022.3.M | 22mm 7/8" | 750 | 19 | 185 | 138 | 46 | 85 | 79 | 10,3 | 52 | | Art.3.3 |
| REF1.0.N.D.028.1.M | 28mm | 1076 | 25 | 185 | 138 | 52 | 90 | 89 | 15,5 | 52 | | Art.3.3 |
| REF1.0.N.D.028.2.M | 1-1/8" | 1076 | 25 | 185 | 146 | 52 | 90 | 89 | 15,5 | 52 | | Art.3.3 |
| REF1.0.N.E.035.3.M | 35mm 1-3/8" | 1322 | 32 | 205 | 146 | 66 | 95 | 94 | 19,7 | 52 | | Class I |
| REF1.0.N.F.042.1.M | 42mm | 2400 | 40 | 240 | 180 | 76 | 115 | 113 | 39,5 | 52 | -40/ +150 | Class I |
| REF1.0.N.F.042.2.M | 1-5/8" | 2400 | 40 | 240 | 180 | 76 | 115 | 113 | 39,5 | 52 | | Class I |
| REF1.0.N.G.054.3.M | 54mm 2-1/8" | 3386 | 50 | 270 | 204 | 90 | 130 | 119 | 73,5 | 52 | | Class I |
| REF1.0.N.G.064.1.M | 64mm | 3470 | 50 | 286 | 222 | 90 | 140 | 137 | 69 | 45 | | Class I |
| REF1.0.N.G.067.2.M | 2-5/8" | 4026 | 50 | 286 | 222 | 90 | 140 | 137 | 75 | 45 | | Class I |
| REF1.0.N.H.064.1.M | 64mm | 7942 | 65 | 360 | 160 | 118 | 170 | 180 | 98 | 45 | | Class I |
| REF1.0.N.H.067.2.M | 2-5/8" | 7886 | 65 | 360 | 160 | 118 | 170 | 180 | 98 | 45 | | Class I |
| REF1.0.N.H.076.3.M | 76mm/3" | 8024 | 65 | 360 | 160 | 118 | 170 | 180 | 105 | 45 | | Class I |
| REF1.0.N.H.080.3.M | 80mm/3-1/8" | 7750 | 65 | 360 | 160 | 118 | 170 | 180 | 105 | 45 | | Class I |

FAQ: How can I recognize the position of the sphere-passages once valve is mounted on the system?

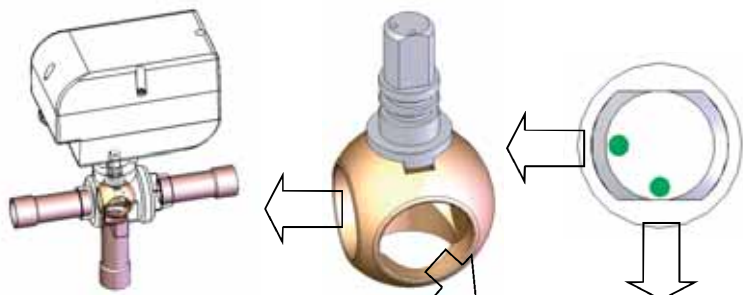
ASWR: It's easy by the two indicator notch on the stem, positioned corresponding with the two sphere port.





 Our bi-flow system allows the mounting of the valve without taking into consideration the direction of the flow. Valves with access port are available. Up to diameter 3/4", schrader port is forged together with the valve-body. Incoming capacity comes from the vertical Tube (always open) and valve allows you to redirect the flow either along one of the two horizontal output directions.

 Il brevettato sistema bidirezionale permette di montare la valvola indipendentemente dalla direzione del flusso. Sono disponibili versioni con valvolina di precarica. Nei diametri fino ai 3/4" è fornita già stampata assieme con il corpo valvola. La capacità in entrata proviene dal tubo verticale (sempre aperto) e la valvola consente di reindirizzare il flusso orizzontalmente lungo una delle due sezioni di scarico.

 Das patentierte Biflow-System ermöglicht die Montage des Ventils unabhängig von der Strömungsrichtung. Es sind auch Varianten mit Vortüllventil lieferbar. Bei den Durchmessern bis 3/4" wird es bereits zusammen mit dem Ventilkörper gegossen, geliefert Die Eintrittskapazität wird durch das vertikale Rohr (immer offen) gegeben, das Ventil ermöglicht den horizontalen Durchfluss entlang einem der zwei Ablaufbereiche weiterzuleiten.

 Notre système bi-directionnel permet d'installer la vanne sans se préoccuper de la direction du flux; également à disposition la vanne avec Schrader. Jusqu'à 3/4", le port schrader est intégré. La capacité est transportée par le conduit vertical (toujours ouvert) et la vanne permet de rediriger le flux le long d'une des deux sections horizontales d'échappement.

 El sistema bidireccional patentado permite montar la válvula independientemente de la dirección del flujo. Están disponibles también aquellas con puerto de acceso. Para los diámetros de hasta 3/4" viene ya ensamblada al cuerpo de la válvula. La capacidad de ingreso proviene del tubo vertical (siempre abierto) y la válvula consiente de redireccionar el flujo horizontalmente a lo largo de las dos secciones de desagüe.

 O sistema bidireccional patentado permite de montar a válvula independentemente da direção do fluxo. Também são disponíveis versões com válvula de pré-carga. As válvulas com diâmetros até 3/4" são fornecidas forjadas no corpo da válvula. O fluxo de entrada é proveniente do tubo vertical (sempre aberto) e a válvula permite redireccionar o fluxo horizontal ao longo de uma das duas seções de descarga.

 弊社バイ・フロー・システムは、フローの方向を考慮に入れないバルブのマウンティングを可能にします。アクセス・ポートを伴うバルブが入手可能です。最大直径3/4インチ、シュレダー・ポートが、バルブ・ボディとフォージ結合されています。入来キャパシティーは、垂直チューブより浸入します（常時開口）。バルブにより、フローをふたつの水平アウトプットのうちのどちらかひとつに沿うように、変更することが可能です。

 Наша двунаправленная система позволяет монтировать клапан без учёта направления потока. Также имеются клапаны с вентилем предварительной загрузки, уже поставленным в тело, диаметром до 3/4". Поток поступает из вертикальной трубы (всегда открытая) и клапан позволяет направить его вдоль одной из двух горизонтально расположенных труб.

3Way Schrader™—Port Ball Valve

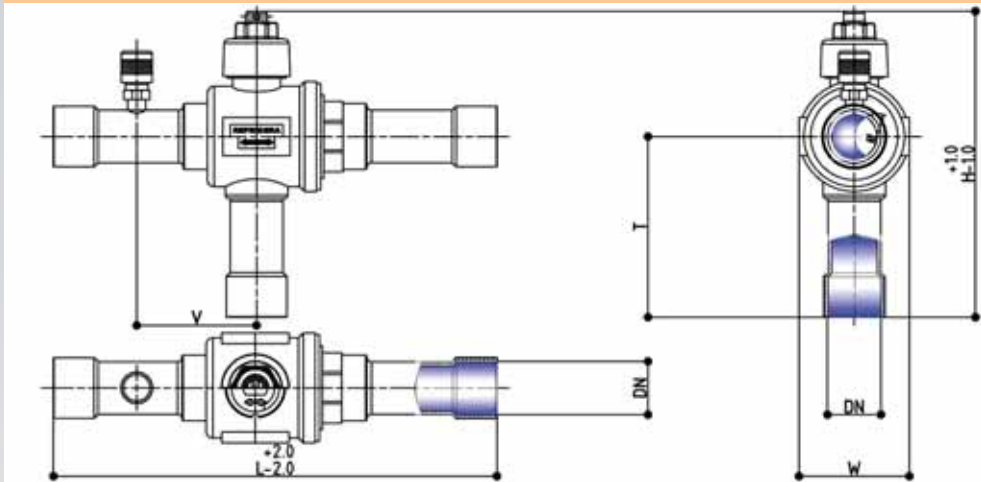
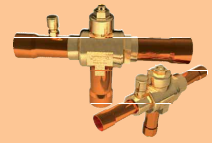



| Code | Connection | Weight | Sphere passage | Length | Height | Wide | V | T | Kv | PS | WTemp | P.E.D. |
|--------------------|-------------|--------|----------------|--------|--------|--------|--------|--------|----------------|-----|-----------|---------------|
| REF | DN | (g) | Ø(mm) | L (mm) | H (mm) | W (mm) | V (mm) | T (mm) | ΔP:1bar (m³/h) | bar | °C | Group2 fluids |
| REF1.0.S.A.006.1.M | 6mm | 90 | 10 | 126 | 71 | 22 | 25 | 46 | 0,8 | 52 | | Art.3.3 |
| REF1.0.S.A.006.2.M | 1/4" | 90 | 10 | 126 | 71 | 22 | 25 | 46 | 0,8 | 52 | | Art.3.3 |
| REF1.0.S.A.008.3.M | 8mm 5/16" | 90 | 10 | 126 | 74 | 22 | 25 | 46 | 0,8 | 52 | | Art.3.3 |
| REF1.0.S.A.010.1.M | 10mm | 108 | 10 | 132 | 74 | 22 | 25 | 48 | 1,8 | 52 | | Art.3.3 |
| REF1.0.S.A.010.2.M | 3/8" | 108 | 10 | 132 | 74 | 22 | 25 | 48 | 1,8 | 52 | | Art.3.3 |
| REF1.0.S.A.012.1.M | 12mm | 120 | 10 | 139 | 80 | 22 | 25 | 57 | 2,7 | 52 | | Art.3.3 |
| REF1.0.S.A.012.2.M | 1/2" | 120 | 10 | 139 | 80 | 22 | 25 | 57 | 2,7 | 52 | | Art.3.3 |
| REF1.0.S.B.015.1.M | 15mm | 360 | 15 | 148 | 109 | 34 | 24 | 61 | 5,5 | 52 | | Art.3.3 |
| REF1.0.S.B.016.3.M | 16mm 5/8" | 360 | 15 | 148 | 109 | 34 | 24 | 61 | 5,6 | 52 | | Art.3.3 |
| REF1.0.S.B.018.1.M | 18mm | 360 | 15 | 153 | 109 | 34 | 24 | 61 | 5,8 | 52 | | Art.3.3 |
| REF1.0.S.B.018.2.M | 3/4" | 360 | 15 | 153 | 109 | 34 | 24 | 61 | 5,8 | 52 | | Art.3.3 |
| REF1.0.S.C.022.3.M | 22mm 7/8" | 750 | 19 | 153 | 138 | 46 | 35 | 79 | 10,3 | 52 | | Art.3.3 |
| REF1.0.S.D.028.1.M | 28mm | 1076 | 25 | 153 | 138 | 52 | 50 | 89 | 15,5 | 52 | | Art.3.3 |
| REF1.0.S.D.028.2.M | 1-1/8" | 1076 | 25 | 185 | 146 | 52 | 50 | 89 | 15,5 | 52 | | Art.3.3 |
| REF1.0.S.E.035.3.M | 35mm 1-3/8" | 1322 | 32 | 205 | 146 | 66 | 64 | 94 | 19,7 | 52 | -40/ +150 | Class I |
| REF1.0.S.F.042.1.M | 42mm | 2400 | 40 | 240 | 180 | 76 | 54 | 113 | 39,5 | 52 | | Class I |
| REF1.0.S.F.042.2.M | 1-5/8" | 2400 | 40 | 240 | 180 | 76 | 54 | 113 | 39,5 | 52 | | Class I |
| REF1.0.S.G.054.3.M | 54mm 2-1/8" | 3386 | 50 | 270 | 204 | 90 | 80 | 119 | 73,5 | 52 | | Class I |
| REF1.0.S.G.064.1.M | 64mm | 3470 | 50 | 286 | 222 | 90 | 80 | 137 | 69 | 45 | | Class I |
| REF1.0.S.G.067.2.M | 2-5/8" | 4026 | 50 | 286 | 222 | 90 | 80 | 137 | 75 | 45 | | Class I |
| REF1.0.S.H.064.1.M | 64mm | 7942 | 65 | 355 | 160 | 118 | 85 | 180 | 98 | 45 | | Class I |
| REF1.0.S.H.067.2.M | 2-5/8" | 7886 | 65 | 355 | 160 | 118 | 85 | 180 | 98 | 45 | | Class I |
| REF1.0.S.H.076.3.M | 76mm/3" | 8024 | 65 | 355 | 160 | 118 | 85 | 180 | 105 | 45 | | Class I |
| REF1.0.S.H.080.3.M | 80mm/3-1/8" | 7750 | 65 | 355 | 160 | 118 | 85 | 180 | 105 | 45 | | Class I |

 Our bi-flow system allows the mounting of the valve without taking into consideration the direction of the flow. The valve allows you to redirect the flow either along one of the two horizontal output directions.

 Il brevettato sistema bidirezionale permette di montare la valvola indipendentemente dalla direzione del flusso. La valvola consente di reindirizzare il flusso orizzontalmente lungo una delle due sezioni di scarico.

 Das patentierte Biflow-System ermöglicht die Montage des Ventils unabhängig von der Strömungsrichtung. Das Ventil ermöglicht den horizontalen Durchfluss entlang einem der zwei Ablaufbereiche weiterzuleiten.

 Notre système bi-directionnel permet d'installer la vanne sans se préoccuper de la direction du flux. La vanne permet de rediriger le flux le long d'une des deux sections horizontales d'échappement.

 El sistema bidireccional patentado permite montar la válvula independientemente de la dirección del flujo. La válvula consiente de redireccionar el flujo horizontalmente a lo largo de las dos secciones de desagüe.

 O sistema bidirecional patenteado permite de montar a válvula independientemente da direção do fluxo. A válvula permite redirecionar o fluxo horizontal ao longo de uma das duas seções de descarga.

 弊社バイ・フロー・システムは、フローの方向を考慮に入れないバルブのマウンティングを可能にします。バルブにより、フローをふたつの水平アウトプットのうちのどちらかひとつに沿うように、変更することが可能です。

 Наша двунаправленная система позволяет монтировать клапан без учёта направления потока. Клапан позволяет направить его вдоль одной из двух горизонтально расположенных труб.

4Way Ball Valve

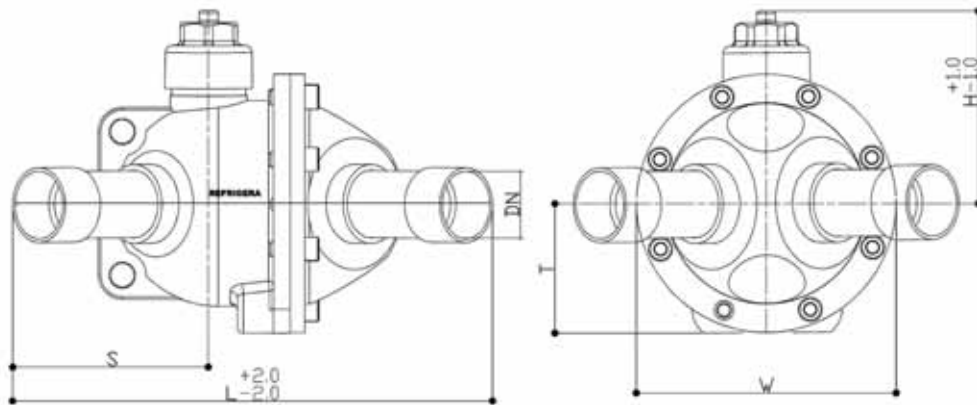
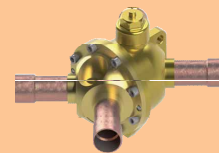

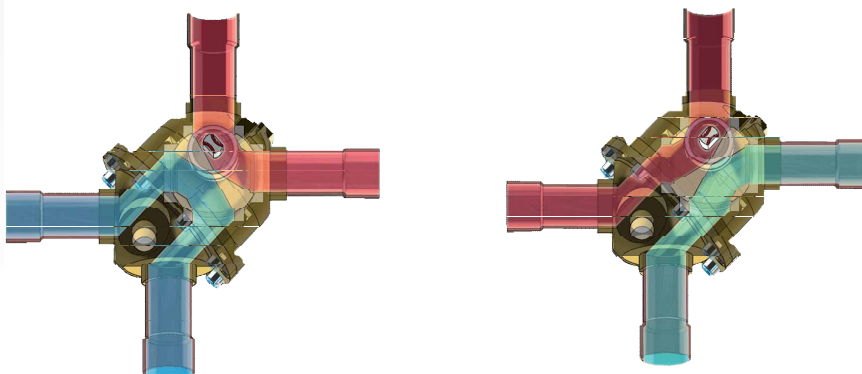
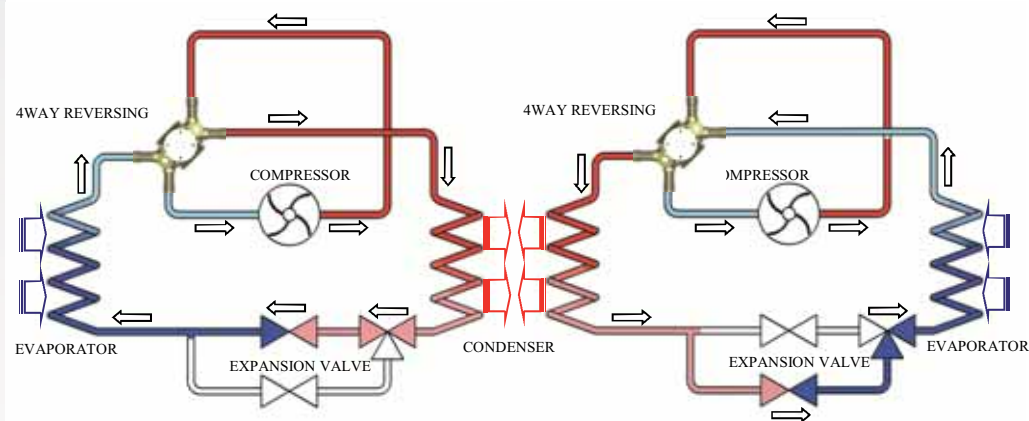

| Code | Connections Size | Weight | Length | Length | Height | Height | Wide | Kvs | Differential inlet/outlet | Wtemp | P.E.D. |
|--------------|------------------|--------|--------|--------|--------|--------|--------|--|---------------------------|--------------------|---------------|
| REF | DN | (g) | S (mm) | L (mm) | T (mm) | H (mm) | W (mm) | $\Delta P: 1 \text{ bar}$ (m^3/h) | ΔPS (bar) | $^{\circ}\text{C}$ | Group2 fluids |
| REF4.0.022.3 | 22 | - | - | - | - | - | - | 12,5 | 40 | | Art.3.3 |
| REF4.0.028.1 | 28 | - | - | - | - | - | - | 12,5 | 40 | -40/ +150 | Art.3.3 |
| REF4.0.028.1 | 1-1/8" | - | - | - | - | - | - | 12,5 | 40 | | Art.3.3 |





THE IMAGE SHOWS: heating and cooling cycles

 La flangia ISO-DIN 5211 standard permette l'accoppiamento delle valvole con tutti gli attuatori attualmente presenti sul mercato per tutti i casi in cui sia necessario il controllo a distanza dell'apertura e chiusura o regolare la direzione del flusso. Il perno di manovra viene montato in configurazione anticoppio ed è progettato a tenuta ermetica.

 The DIN ISO-5211 standard flange, allows to fit valves with all the actuators on the market, when it is necessary the remote control of opening and closing or adjusting the direction of flow. The lever shaft is mounted in explosion-proof configuration and is hermetic airtight designed.

 Der Standardflansch ISO-DIN 5211 ermöglicht in allen Fällen, in denen die Fernsteuerung der Öffnung und Schließung oder die Durchflussrichtung zu regeln ist, den Anschluss der Ventile an alle momentan auf dem Markt befindlichen Antriebe. Der Schaltzapfen wird mit einer Berstsicherung montiert und verfügt über eine hermetische Dichtung.

 La bride ISO-DIN 5211 standard permet de créer la paire de vannes pour tous les acteurs sur le marché aujourd'hui, pour tous les cas où il est nécessaire d'utiliser la télécommande d'ouverture et de fermeture ou de réglage de la direction du flux. Le levier est monté dans une configuration anti explosion, conçu hermétiquement avec le joint O-Ring R744, compatible pour le R744.

 La brida ISO-DIN 5211 estándar permite acoplar las válvulas con todos los actuadores presentes en el mercado en los cuales sea necesario el control a distancia de la apertura y cierre o para regular la dirección del flujo. El perno de maniobra viene montado con configuración antideflagrante y fijado hermético.

 O flange padrão ISO-DIN 5211, permite o acoplamento das válvulas com todos os atuadores atualmente disponíveis no comércio para todos os casos em que for necessário controlar à distância, tanto a abertura como o fechamento ou então regular a direção do fluxo. O pivô é montado na configuração à prova de explosão e lacrado hermeticamente.

 DIN ISO-5211水準の同フランジは、市場に存在するすべてのアクチュエーターにバルブをフィットさせることを可能とします。これは、開口と閉口、あるいはフローの方向調節をリモート・コントロールする際に必要となります。レバー・シャフトが、爆発防止の設定でマウントされており、完封エアタイト設計されています。

 Стандартный фланец DIN ISO-5211 позволяет соединению клапанов со всеми приводами рынка. Полезно в тех случаях, когда нужно удаленного контроля или регулирования открытия и закрытия потока. Рычаг вала осуществляет взрывобезопасную функцию и он герметично запечатан.

Ball Valve Fit for Actuator

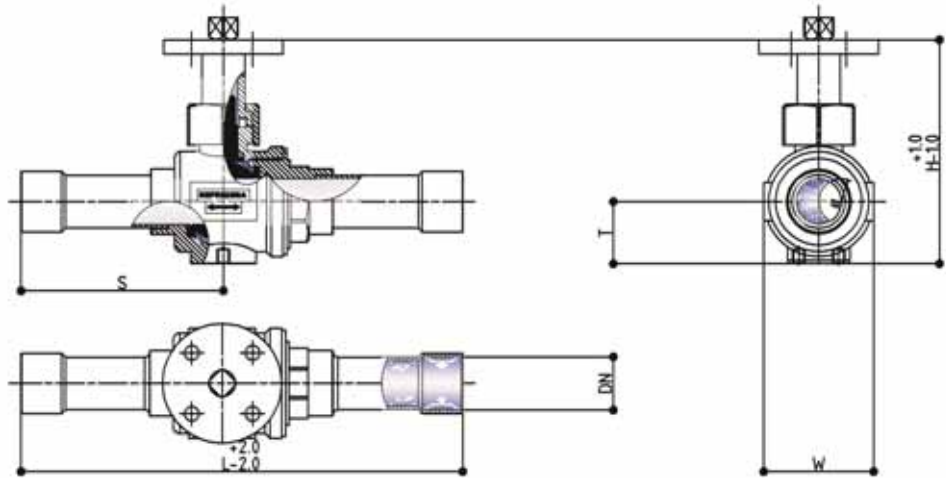



| Code | Connection | Weight | Sphere passage | Length | Height | Wide | S | T | Kv | PS | WTemp | P.E.D. |
|----------------------|--------------|--------|----------------|--------|--------|--------|--------|--------|----------------|-----|-----------|---------------|
| REF | DN | (g) | Ø(mm) | L (mm) | H (mm) | W (mm) | S (mm) | T (mm) | ΔP:1bar (m³/h) | bar | °C | Group2 fluids |
| REF1.0.S.A.006.1.P | 6mm | 90 | 10 | 126 | 107 | 22 | 60 | 15 | 1,0 | 52 | | Art.3.3 |
| REF1.0.S.A.006.2.P | 1/4" | 90 | 10 | 126 | 107 | 22 | 60 | 15 | 1,0 | 52 | | Art.3.3 |
| REF1.0.S.A.008.3.P | 8mm 5/16" | 90 | 10 | 126 | 107 | 22 | 60 | 15 | 1,0 | 52 | | Art.3.3 |
| REF1.0.S.A.010.1.P | 10mm | 108 | 10 | 132 | 107 | 22 | 63 | 15 | 2,4 | 52 | | Art.3.3 |
| REF1.0.S.A.010.2.P | 3/8" | 108 | 10 | 132 | 107 | 22 | 63 | 15 | 2,4 | 52 | | Art.3.3 |
| REF1.0.S.A.012.1.P | 12mm | 120 | 10 | 139 | 107 | 22 | 67 | 15 | 2,7 | 52 | | Art.3.3 |
| REF1.0.S.A.012.2.P | 1/2" | 120 | 10 | 139 | 78 | 22 | 67 | 17 | 2,7 | 52 | | Art.3.3 |
| REF1.0.N.B.015.1.P | 15mm | 360 | 15 | 148 | 78 | 34 | 68 | 17 | 12,5 | 52 | | Art.3.3 |
| REF1.0.N.B.016.3.P | 16mm 5/8" | 360 | 15 | 148 | 78 | 34 | 68 | 17 | 13 | 52 | | Art.3.3 |
| REF1.0.N.B.018.1.P | 18mm | 360 | 15 | 148 | 78 | 34 | 68 | 17 | 14 | 52 | | Art.3.3 |
| REF1.0.N.B.018.2.P | 3/4" | 360 | 15 | 148 | 78 | 34 | 68 | 17 | 14 | 52 | | Art.3.3 |
| REF1.0.S.B.015.1.P | 15mm | 360 | 15 | 153 | 78 | 34 | 68 | 17 | 12,5 | 52 | | Art.3.3 |
| REF1.0.S.B.016.3.P | 16mm 5/8" | 360 | 15 | 153 | 78 | 34 | 68 | 17 | 13 | 52 | | Art.3.3 |
| REF1.0.S.B.018.1.P | 18mm | 360 | 15 | 153 | 78 | 34 | 68 | 17 | 14 | 52 | | Art.3.3 |
| REF1.0.S.B.018.2.P | 3/4" | 360 | 15 | 153 | 78 | 34 | 68 | 17 | 14 | 52 | | Art.3.3 |
| REF1.0.N.C.022.3.P | 22mm 7/8" | 750 | 19 | 185 | 92 | 46 | 85 | 26 | 24 | 52 | | Art.3.3 |
| REF1.0.N.D.028.1.P | 28mm | 1076 | 25 | 185 | 98 | 52 | 90 | 28 | 40 | 52 | | Art.3.3 |
| REF1.0.N.D.028.2.P | 1-1/8" | 1076 | 25 | 185 | 98 | 52 | 90 | 28 | 40 | 52 | -20/ +100 | Art.3.3 |
| REF1.0.N.E.035.3.P | 35mm 1-3/8" | 1322 | 32 | 205 | 110 | 66 | 95 | 31 | 67,3 | 52 | | Class I |
| REF1.0.N.F.042.1.P | 42mm | 2400 | 40 | 240 | 110 | 76 | 115 | 48 | 98 | 52 | | Class I |
| REF1.0.N.F.042.2.P | 1-5/8" | 2400 | 40 | 240 | 110 | 76 | 115 | 48 | 98 | 52 | | Class I |
| REF1.0.N.G.054.3.P | 54mm 2-1/8" | 3386 | 50 | 270 | 150 | 90 | 130 | 45 | 190 | 45 | | Class I |
| REF1.0.N.G.064.1.P | 64mm | 3470 | 50 | 286 | 150 | 90 | 140 | 45 | 200 | 45 | | Class I |
| REF1.0.N.G.067.2.P | 2-5/8" | 4026 | 50 | 286 | 150 | 90 | 140 | 45 | 210 | 45 | | Class I |
| REF1.0.N.H.064.1.P | 64mm | 7942 | 65 | 355 | 160 | 76 | 115 | 62 | 98 | 45 | | Class I |
| REF1.0.N.H.067.2.P | 2-5/8" | 7886 | 65 | 355 | 160 | 90 | 130 | 62 | 190 | 45 | | Class I |
| REF1.0.N.H.076.3.P | 76mm 3" | 8024 | 65 | 355 | 160 | 90 | 140 | 62 | 200 | 45 | | Class I |
| REF1.0.N.H.080.3.P | 80mm 3-1/8" | 7750 | 65 | 355 | 160 | 90 | 140 | 62 | 210 | 45 | | Class I |
| REF1.0.N.L.080.3.P | 80mm 3-1/8" | 15162 | 80 | 390 | 195 | 150 | 212 | 77 | 500 | 40 | | Class I |
| REF1.0.N.L.089.3.P | 89mm 3-1/2" | 15044 | 80 | 390 | 195 | 150 | 212 | 77 | 520 | 40 | | Class I |
| REF1.0.N.L.092.2.P | 3-5/8" | 16800 | 80 | 390 | 195 | 150 | 212 | 77 | 535 | 40 | | Class I |
| REF1.0.N.L.105.3.P | 105mm 4-1/8" | 17205 | 80 | 380 | 195 | 150 | 212 | 77 | 570 | 40 | | Class I |
| REF1.0.N.L.108.3.P | 108mm 4-1/4" | 14908 | 80 | 380 | 195 | 150 | 212 | 77 | 575 | 40 | | Class I |
| REF1.0.N.M.115.3.AAP | 115mm | 19806 | 100 | 325 | 220 | 173 | 244 | 90 | 860 | | | Class I |
| REF1.0.N.M.127.3.AAP | 127mm | 19806 | 100 | 325 | 220 | 173 | 244 | 90 | 880 | 32 | | Class I |

*CONNECTION KIT ARE SOLD SEPARATELY. PLS REFER TO CONNECTION KIT PAGE

 La flangia ISO-DIN 5211 standard permette l'accoppiamento delle valvole con tutti gli attuatori attualmente presenti sul mercato per tutti i casi in cui sia necessario il controllo a distanza dell'apertura e chiusura o regolare la direzione del flusso. Il perno di manovra viene montato in configurazione antiscoppio ed è progettato a tenuta ermetica.

 The DIN ISO-5211 standard flange, allows to fit valves with all the actuators on the market, when it is necessary the remote control of opening and closing or adjusting the direction of flow. The lever shaft is mounted in explosion-proof configuration and is hermetic airtight designed.

 Der Standardflansch ISO-DIN 5211 ermöglicht in allen Fällen, in denen die Fernsteuerung der Öffnung und Schließung oder die Durchflussrichtung zu regeln ist, den Anschluss der Ventile an alle momentan auf dem Markt befindlichen Antriebe. Der Schaltzapfen wird mit einer Berstsicherung montiert und verfügt über eine hermetische Dichtung.

 La bride ISO-DIN 5211 standard permet de créer la paire de vannes pour tous les acteurs sur le marché aujourd'hui, pour tous les cas où il est nécessaire d'utiliser la télécommande d'ouverture et de fermeture ou de réglage de la direction du flux. Le levier est monté dans une configuration anti explosion, conçu hermétiquement avec le joint O-Ring R744, compatible pour le R744.

 La brida ISO-DIN 5211 estándar permite acopiar las válvulas con todos los actuadores presentes en el mercado en los cuales sea necesario el control a distancia de la apertura y cierre o para regular la dirección del flujo. El perno de maniobra viene montado con configuración antideflagrante y fijado hermético.

 O flange padrão ISO-DIN 5211, permite o acoplamento das válvulas com todos os atuadores atualmente disponíveis no comércio para todos os casos em que for necessário controlar à distância, tanto a abertura como o fechamento ou então regular a direção do fluxo. O pivô é montado na configuração à prova de explosão e lacrado hermeticamente.

 DIN ISO-5211 水準の同フランジは、市場に存在するすべてのアクチュエーター(バルブ)をフィットさせることを可能とします。これは、開口と閉口、あるいはフローの方向調節をリモート・コントロールする際に必要となります。レバー・シャフトが、爆発防止の設定でマウントされており、完封エアタイト設計されています。

 Стандартный фланец DIN ISO-5211 позволяет соединению клапанов со всеми приводами рынка. Полезно в тех случаях, когда нужно удаленного контроля или регулирование открытия и закрытия потока. Рычаг вала осуществляет взрывобезопасную функцию и он герметично запечатан.

3Way Ball Valve Fit for Actuator

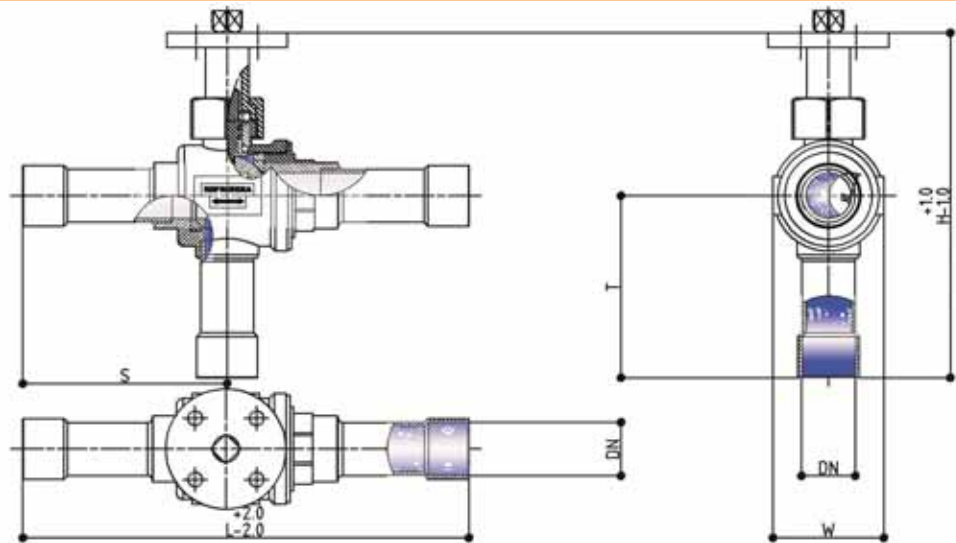



| Code | Connection | Weight | Sphere passage | Length | Height | Wide | S | T | Kv | PS | WTemp | P.E.D. |
|----------------------|-------------|--------|----------------|--------|--------|--------|--------|--------|----------------|-----|-----------|---------------|
| REF | DN | (g) | Ø(mm) | L (mm) | H (mm) | W (mm) | S (mm) | T (mm) | ΔP:1bar (m³/h) | bar | °C | Group2 fluids |
| REF1.0.S.A.006.1.M.P | 6mm | 90 | 10 | 126 | 107 | 22 | 60 | 46 | 0,8 | 52 | | Art.3.3 |
| REF1.0.S.A.006.2.M.P | 1/4" | 90 | 10 | 126 | 107 | 22 | 60 | 46 | 0,8 | 52 | | Art.3.3 |
| REF1.0.S.A.008.3.M.P | 8mm 5/16" | 90 | 10 | 126 | 107 | 22 | 60 | 46 | 0,8 | 52 | | Art.3.3 |
| REF1.0.S.A.010.1.M.P | 10mm | 108 | 10 | 132 | 107 | 22 | 63 | 48 | 1,8 | 52 | | Art.3.3 |
| REF1.0.S.A.010.2.M.P | 3/8" | 108 | 10 | 132 | 107 | 22 | 63 | 48 | 1,8 | 52 | | Art.3.3 |
| REF1.0.S.A.012.1.M.P | 12mm | 120 | 10 | 139 | 107 | 22 | 67 | 57 | 2,7 | 52 | | Art.3.3 |
| REF1.0.S.A.012.2.M.P | 1/2" | 120 | 10 | 139 | 78 | 22 | 67 | 57 | 2,7 | 52 | | Art.3.3 |
| REF1.0.N.B.015.1.M.P | 15mm | 360 | 15 | 148 | 78 | 34 | 68 | 61 | 5,5 | 52 | | Art.3.3 |
| REF1.0.N.B.016.3.M.P | 16mm 5/8" | 360 | 15 | 148 | 78 | 34 | 68 | 61 | 5,6 | 52 | | Art.3.3 |
| REF1.0.N.B.018.1.M.P | 18mm | 360 | 15 | 148 | 78 | 34 | 68 | 61 | 5,8 | 52 | | Art.3.3 |
| REF1.0.N.B.018.2.M.P | 3/4" | 360 | 15 | 148 | 78 | 34 | 68 | 61 | 5,8 | 52 | | Art.3.3 |
| REF1.0.S.B.015.1.M.P | 15mm | 360 | 15 | 153 | 78 | 34 | 68 | 61 | 5,5 | 52 | | Art.3.3 |
| REF1.0.S.B.016.3.M.P | 16mm 5/8" | 360 | 15 | 153 | 78 | 34 | 68 | 61 | 5,6 | 52 | | Art.3.3 |
| REF1.0.S.B.018.1.M.P | 18mm | 360 | 15 | 153 | 78 | 34 | 68 | 61 | 5,8 | 52 | | Art.3.3 |
| REF1.0.S.B.018.2.M.P | 3/4" | 360 | 15 | 153 | 78 | 34 | 68 | 61 | 5,8 | 52 | -20/ +100 | Art.3.3 |
| REF1.0.N.C.022.3.M.P | 22mm 7/8" | 750 | 19 | 185 | 92 | 46 | 85 | 79 | 10,3 | 52 | | Art.3.3 |
| REF1.0.N.D.028.1.M.P | 28mm | 1076 | 25 | 185 | 98 | 52 | 90 | 89 | 15,5 | 52 | | Art.3.3 |
| REF1.0.N.D.028.2.M.P | 1-1/8" | 1076 | 25 | 185 | 98 | 52 | 90 | 89 | 15,5 | 52 | | Art.3.3 |
| REF1.0.N.E.035.3.M.P | 35mm 1-3/8" | 1322 | 32 | 205 | 110 | 66 | 95 | 94 | 19,7 | 52 | | Class I |
| REF1.0.N.F.042.1.M.P | 42mm | 2400 | 40 | 240 | 110 | 76 | 115 | 113 | 39,5 | 52 | | Class I |
| REF1.0.N.F.042.2.M.P | 1-5/8" | 2400 | 40 | 240 | 110 | 76 | 115 | 113 | 39,5 | 52 | | Class I |
| REF1.0.N.G.054.3.M.P | 54mm 2-1/8" | 3386 | 50 | 270 | 150 | 90 | 130 | 119 | 73,5 | 52 | | Class I |
| REF1.0.N.G.064.1.M.P | 64mm | 3470 | 50 | 286 | 150 | 90 | 140 | 137 | 69 | 45 | | Class I |
| REF1.0.N.G.067.2.M.P | 2-5/8" | 4026 | 50 | 286 | 150 | 90 | 140 | 137 | 75 | 45 | | Class I |
| REF1.0.N.H.064.1.M.P | 64mm | 7942 | 65 | 355 | 160 | 118 | 170 | 180 | 98 | 45 | | Class I |
| REF1.0.N.H.067.2.M.P | 2-5/8" | 7886 | 65 | 355 | 160 | 118 | 170 | 180 | 98 | 45 | | Class I |
| REF1.0.N.H.076.3.M.P | 76mm/3" | 8024 | 65 | 355 | 160 | 118 | 170 | 180 | 105 | 45 | | Class I |
| REF1.0.N.H.080.3.M.P | 80mm/3-1/8" | 7750 | 65 | 355 | 160 | 118 | 170 | 180 | 105 | 45 | | Class I |

*CONNECTION KIT ARE SOLD SEPARATELY; PLS REFER TO CONNECTION KIT PAGE

 The DIN ISO-5211 standard flange, allows to fit valves with all the actuators on the market, when it is necessary the remote control of opening and closing or adjusting the direction of flow. The lever shaft is mounted in explosion-proof configuration and is hermetic airtight designed.

 La flangia ISO-DIN 5211 standard permette l'accoppiamento delle valvole con tutti gli attuatori attualmente presenti sul mercato per tutti i casi in cui sia necessario il controllo a distanza dell'apertura e chiusura o regolare la direzione del flusso. Il perno di manovra viene montato in configurazione antisceppio ed è progettato a tenuta ermetica.

 Der Standardflansch ISO-DIN 5211 ermöglicht in allen Fällen, in denen die Fernsteuerung der Öffnung und Schließung oder die Durchflussrichtung zu regeln ist, den Anschluss der Ventile an alle momentan auf dem Markt befindlichen Antriebe. Der Schaltzapfen wird mit einer Berstsicherung montiert und verfügt über eine hermetische Dichtung.

 La bride ISO-DIN 5211 standard permet de créer la paire de vannes pour tous les acteurs sur le marché aujourd'hui, pour tous les cas où il est nécessaire d'utiliser la télécommande d'ouverture et de fermeture ou de réglage de la direction du flux. Le levier est monté dans une configuration anti explosion, conçu hermétiquement avec le joint O-Ring.

 La brida ISO-DIN 5211 estándar permite acopiar las válvulas con todos los actuadores presentes en el mercado en los cuales sea necesario el control a distancia de la apertura y cierre o para regular la dirección del flujo. El perno de maniobra viene montado con configuración antideflagrante y fijado hermético.

 O flange padrão ISO-DIN 5211, permite o acoplamento das válvulas com todos os atuadores atualmente disponíveis no comércio para todos os casos em que for necessário controlar à distância, tanto a abertura como o fechamento ou então regular a direção do fluxo. O pivô é montado na configuração à prova de explosão e lacrado hermeticamente.

 DIN ISO-5211水準の同フランジは、市場に存在するすべてのアクチュエーターにバルブをフィットさせることを可能とします。これは、開口と閉口、あるいはフローの方向調節をリモート・コントロールする際に必要となります。レバー・シャフトが、爆発防止の設定でマウントされており、完封エアタイト設計されています。

 Стандартный фланец DIN ISO-5211 позволяет соединению клапанов со всеми приводами рынка. Полезно в тех случаях, когда нужно удаленного контроля или регулирования открытия и закрытия потока. Рычаг вала осуществляет взрывобезопасную функцию и он герметично запечатан.

4Way Ball Valve fit for Actuator

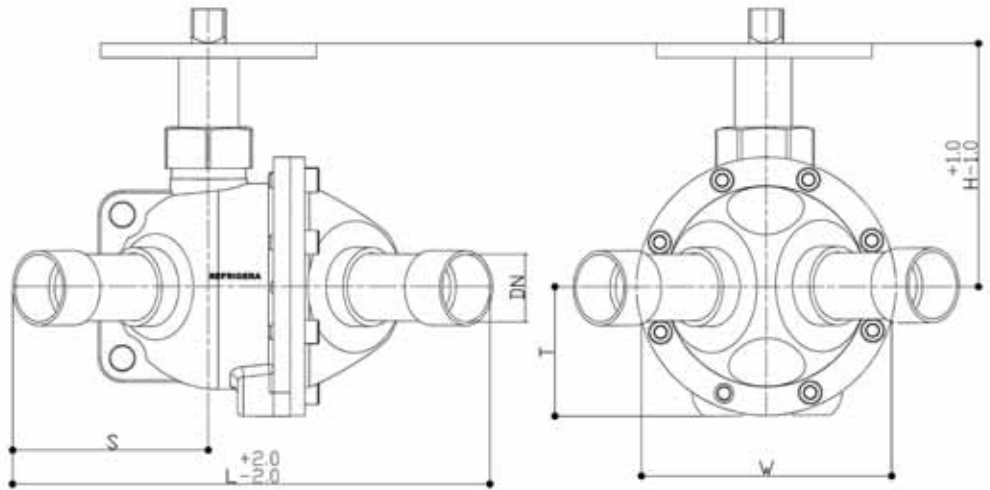
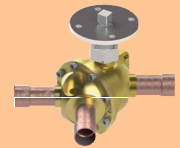

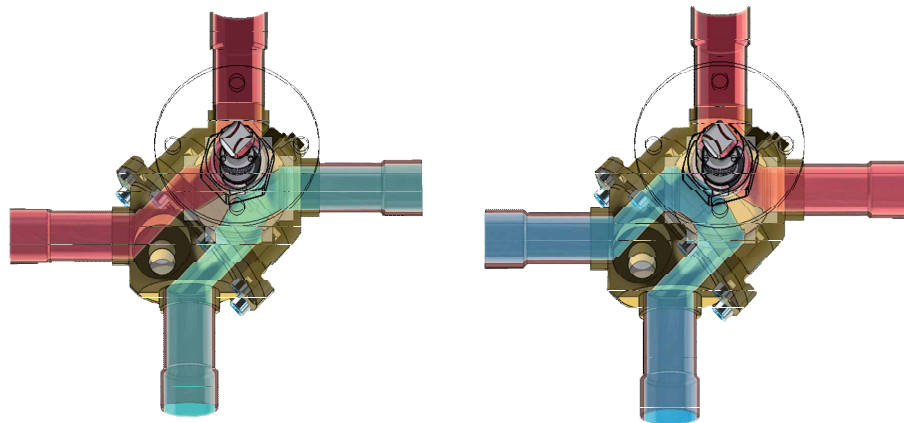

| Code | Connections Size | Weight | Length | Length | Height | Height | Wide | Kvs | Differential inlet/outlet | Wtemp | P.E.D. |
|----------------|------------------|--------|--------|--------|--------|--------|--------|--|---------------------------|-----------|---------------|
| REF | DN | (g) | S (mm) | L (mm) | T (mm) | H (mm) | W (mm) | $\Delta P: 1 \text{ bar}$ (m ³ /h) | ΔPS (bar) | °C | Group2 fluids |
| REF4.0.022.3.P | 22 | - | - | - | - | - | - | 12,5 | 40 | | Art.3.3 |
| REF4.0.028.1.P | 28 | - | - | - | - | - | - | 12,5 | 40 | -20/ +100 | Art.3.3 |
| REF4.0.028.1.P | 1-1/8" | - | - | - | - | - | - | 12,5 | 40 | | Art.3.3 |





THE IMAGE SHOWS: cooling and heating cycles in a 4Way B.V.

 A Danfoss™ Turbocor™ is 33% to 50% more efficient than other compressor technologies. Refrigerera™ valve is designed to follow the exceptional compressor performance and to support its high efficiency.

 I compressori Danfoss™ della serie Turbocor™ posseggono un grado di efficienza dal 33% al 50% maggiore rispetto ai vite tradizionali. Le valvole Refrigerera™ per compressori, sono state progettate appositamente per adattarsi alle performance di questa nuova tecnologia e favorirne l'alta efficienza.

 Die Danfoss™-Verdichter der Serie Turbocor™ weisen einen 33% bis 50% höheren Effizienzgrad als die herkömmlichen Schraubenverdichter auf. Die Ventile Refrigerera™ für Verdichter wurden eigens zur Anpassung an die Leistungen dieser neuen Technik und zur Unterstützung der hohen Effizienz geplant.

 Les compresseurs Danfoss™ Turbocor™ possèdent un taux d'efficacité de 33% à 50% plus élevé que d'autres technologies de compression. La vanne Refrigerera™ est conçue pour suivre les performances exceptionnelles du compresseur et pour soutenir sa haute efficacité énergétique.

 Los compresores Danfoss™ de la serie Turbocor™ poseen un grado de eficiencia del 33% al 50% mayor con respecto a los tornillos tradicionales. Las válvulas para compresores Refrigerera™ son proyectadas expresamente para adaptarse al rendimiento de esta nueva tecnología y favorecer un alto rendimiento.

 Os compressores Danfoss da série Turbocor possuem um grau de eficiência de 33% a 50% superior em relação aos parafusos convencionais. As válvulas Refrigerera para compressores foram apropriadamente projetadas para se adaptar à performance desta nova tecnologia e favorecer alto rendimento.

 ダンフォス・ターボコア™ は、他のコンプレッサー・テクノロジーと比較し、33%から50%、効率的です。レフリジェラ・バルブは、この卓越したコンプレッサー・パフォーマンスを生かし、その高効率性をサポートするよう、設計されています。

 Компрессоры Danfoss Turbocor™ 33% до 50% более эффективные, чем другие технологии компрессора. Refrigerera™ клапан предназначен для этой новой исключительной производительности компрессора и чтобы поддерживать его высокую эффективность.

Ball Valve for Turbocor™ Compressor

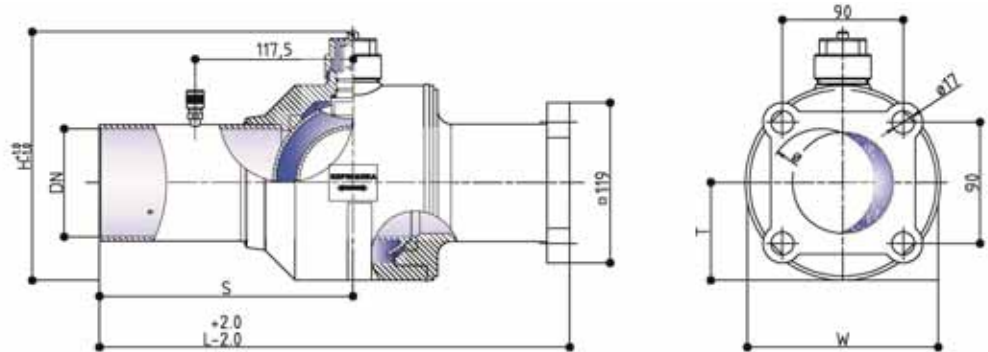
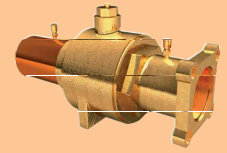



| Code | Connection | Weight | Sphere passage | Length | Height | Wide | S | T | Kv | WTemp | P.E.D. |
|------------------|--------------|--------|----------------|--------|--------|--------|--------|--------|----------------|-----------|---------------|
| REF | DN | (g) | Ø(mm) | L (mm) | H (mm) | W (mm) | S (mm) | T (mm) | ΔP:1bar (m³/h) | °C | Group2 fluids |
| REF5.0.S.L.080.3 | 80mm 3-1/8" | 12530 | 80 | 350 | 185 | 143 | 190 | 65 | 77 | | Class I |
| REF5.0.S.L.089.1 | 89mm 3-1/2" | 12530 | 80 | 350 | 185 | 143 | 190 | 65 | 77 | | Class I |
| REF5.0.S.L.092.2 | 3-5/8" | 12530 | 80 | 350 | 185 | 143 | 190 | 65 | 77 | -40/ +150 | Class I |
| REF5.0.S.L.105.3 | 105mm 4-1/8" | 12530 | 80 | 350 | 185 | 143 | 190 | 65 | 80 | | Class I |
| REF5.0.S.L.108.3 | 108mm 4-1/4" | 12530 | 80 | 350 | 185 | 143 | 190 | 65 | 80 | | Class I |





THE IMAGE SHOWS: a TURBOCOR-flanged Ball Valve

 Our bi-flow system allows the mounting of the valve without taking into consideration the direction of the flow. The small equalization hole on the sphere will allow the valve to support the gas pressure without stressing other components. Special executions: flare-flare or sweat-flare valves are available.

 Il brevettato sistema bidirezionale permette di montare la valvola indipendentemente dalla direzione del flusso. Il piccolo foro sulla sfera fa sì che la valvola possa sopportare la pressione del gas senza sollecitare i seggi di tenuta. Si eseguono valvole in esecuzioni speciali filettate-filettate oppure filettate-a saldare.

 Das patentierte Zweigeweisystem ermöglicht die Montage des Ventils unabhängig von der Strömungsrichtung. Die kleine Bohrung auf der Kugel sorgt dafür, dass das Ventil den Gasdruck aushält ohne die Dichtungssitze zu belasten. Gefertigt werden Ventile in Sonderanfertigungen, wie gebördelt oder gebördelt zum Löten.

 Notre système bi-directionnel permet d'installer la vanne sans se préoccuper de la direction du flux. Le petit trou permet à la vanne de supporter la pression du gaz utilisé sans trop solliciter les autres composants. Exécutions spéciales flare ou sweat-flare disponibles.

 El sistema bidireccional patentado permite montar la válvula independientemente de la dirección del flujo. El pequeño orificio sobre la esfera hace que la válvula pueda soportar la presión del gas sin presionar los asientos de contención.

 O sistema bidireccional patentado permite de montar a válvula independentemente da direção do fluxo. O pequeno orificio sobre a esfera faz com a válvula possa suportar a pressão do gás sem forçar as sedes de vedação. Produzimos válvulas com funcionamentos especiais tais como, de rosca-rosqueadas ou de rosca-para solda.

 弊社バイ・フロー・システムはフローの方向を考慮に入れないバルブのマウンティングを可能とします。スフィア上の小さいコライゼーション・ホールにより、バルブは、他のコンポーネントをストレスさせずにガス・プレッシャーをサポートすることが可能です。特別生産:フレア・フレア、もしくはスウェット・フレア・バルブが入手可能です。

 Наша двунаправленная система позволяет монтировать клапан без учёта направления потока. Небольшое отверстие на шаре позволяет клапану выдерживать давление газа без нагрузки на остальной материал. Имеются винтовые клапаны и пайка-винтовые клапаны.

ODS-NPT Ball Valve

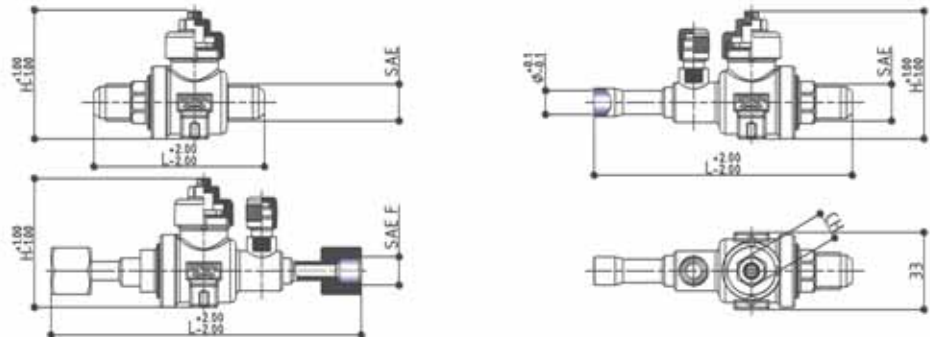

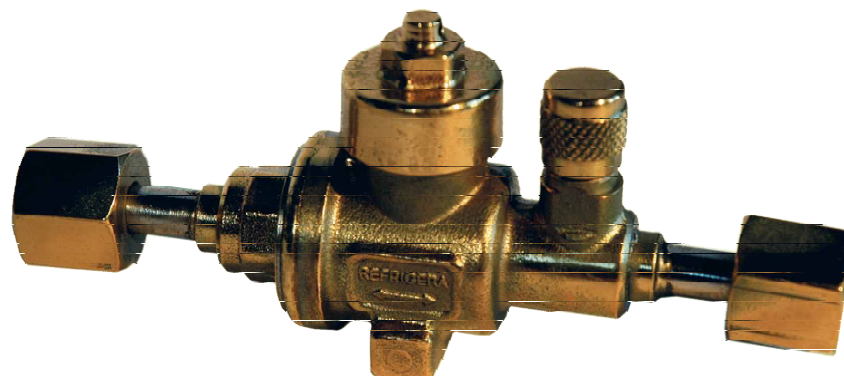

| Code | Connection | Weight | Sphere passage | Length | Height | Wide | NB | Kv | WTemp | P.E.D. |
|----------------------|------------|--------|----------------|--------|--------|--------|------|----------------|-----------|---------------|
| REF | DN (mm) | (g) | Ø(mm) | L (mm) | H (mm) | W (mm) | NPT | ΔP:1bar (m³/h) | °C | Group2 fluids |
| REF1.1.N.P12.016.120 | 16 | 290 | 10 | 115 | 56 | 33 | 1/2" | 0,6 | -40/ +150 | Art.3.3 |
| REF1.1.N.P12.018.120 | 18 | 290 | 10 | 115 | 56 | 33 | 1/2" | 0,6 | | Art.3.3 |
| REF1.1.N.P01.022.120 | 22 | 290 | 10 | 155 | 83 | 45 | 1" | 1,2 | | Art.3.3 |





THE IMAGE SHOWS: SAE female / SAE female ball valve useful to be mounted without brazing

 Our Check Valves can be mounted in every position and offer the best performance with reduced pressure drops. 2-5/8" + 3-1/8" valves are made of steel.

 Le nostre valvole di ritengo possono essere montate in qualunque posizione e offrono il migliore fattore di flusso con la minima perdita di carico. I diametri da 2-5/8" a 3-1/8" sono realizzati in acciaio.

 Unsere Rueckschlagventile koennen in alles Positionen montiert werden und dieten die beste Leistung mit reduzierten Druckvers. 2-5/8" bis 3-1/8" Stahlvermickelt ist vorgesehen.

 Notre Clapets peut être monté dans toutes les positions et offrir la meilleure performance avec une baisse de la pression réduite. Les diamètres de 2-5/8" à 3-1/8" sont fabriqués en acier.

 Nuestras válvulas pueden ser montadas en cualquier posición y ofrecen el mejor factor de flujo con la mínima pérdida de carga. Los diámetros de 2-5/8" a 3-1/8" son realizados en acero.

 As nossas válvulas de retenção podem ser montadas em qualquer posição e oferecem o melhor fator de fluxo com uma queda mínima de pressão. As válvulas com diâmetros de 2-5/8" a 3-1/8" são inteiramente realizadas em aço.

 弊社チェック・バルブは、あらゆるポジションでマウントすることができ、減少されたプレッシャー・ドロップで、最高のパフォーマンスを提供することができます。2インチ5/8から3インチ1/8のバルブが、スチールで作られています。

 Наши обратные клапаны могут монтироваться в любом положении и обеспечивают лучший коэффициент потока при минимальных потерях. Клапаны 2-5/8" + 3-1/8" изготавливаются из стали.

Check Valve

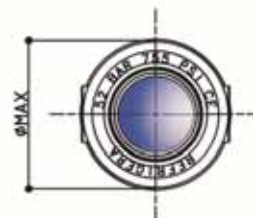
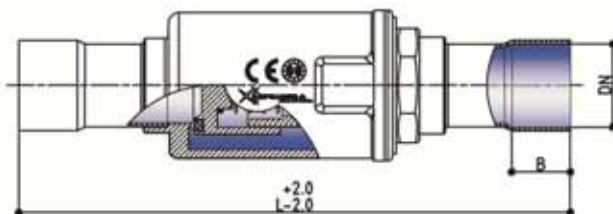



| Code | Connections | Weight | ODS | B | Length | Ø Max | PS | P.E.D. |
|----------------|---------------|--------|------|----|--------|-------|-----|---------------|
| REF | DN | (g) | mm | mm | mm | mm | bar | Group2 fluids |
| REF3.0.N.006 | 6mm | 95 | 6,1 | 7 | 107 | 24 | 52 | Art.3.3 |
| REF3.0.N.014 | 1/4" | 95 | 6,4 | 7 | 107 | 24 | 52 | Art.3.3 |
| REF3.0.N.008 | 8mm (5/16") | 95 | 8,1 | 7 | 112 | 24 | 52 | Art.3.3 |
| REF3.0.N.010 | 10mm | 96 | 10,2 | 9 | 112 | 24 | 52 | Art.3.3 |
| REF3.0.N.038 | 3/8" | 96 | 9,7 | 9 | 112 | 24 | 52 | Art.3.3 |
| REF3.0.N.012 | 12mm | 100 | 12,2 | 12 | 120 | 24 | 52 | Art.3.3 |
| REF3.0.N.127 | 1/2" | 100 | 12,8 | 12 | 120 | 24 | 52 | Art.3.3 |
| REF3.0.N.015 | 15mm | 285 | 15,2 | 12 | 152 | 36 | 52 | Art.3.3 |
| REF3.0.N.016 | 16mm (5/8") | 280 | 16,2 | 14 | 152 | 36 | 52 | Art.3.3 |
| REF3.0.N.018 | 18mm | 285 | 18,2 | 14 | 152 | 36 | 52 | Art.3.3 |
| REF3.0.N.034 | 3/4" | 285 | 19,3 | 14 | 152 | 36 | 52 | Art.3.3 |
| REF3.0.N.022 | 22mm (7/8") | 350 | 22,3 | 17 | 180 | 36 | 52 | Art.3.3 |
| REF3.0.N.028 | 28mm | 1200 | 28,2 | 20 | 230 | 55 | 52 | Art.3.3 |
| REF3.0.N.118 | 1-1/8" | 1200 | 28,8 | 20 | 230 | 55 | 52 | Art.3.3 |
| REF3.0.N.035 | 35mm (1-3/8") | 1560 | 35,2 | 25 | 240 | 66 | 52 | Class I |
| REF3.0.N.042 | 42mm | 2390 | 42,2 | 28 | 270 | 80 | 52 | Class I |
| REF3.0.N.158 | 1-5/8" | 2390 | 41,5 | 28 | 270 | 80 | 52 | Class I |
| REF3.0.N.054 | 54mm (2-1/8") | 3430 | 54,3 | 36 | 295 | 93 | 52 | Class I |
| REF3.0.N.064.W | 64mm | 3510 | 64,0 | 36 | 310 | 93 | 45 | Class I |
| REF3.0.N.258.W | 2-5/8" | 3510 | 66,8 | 36 | 310 | 93 | 45 | Class I |
| REF3.0.N.064 | 64mm | 3530 | 64,0 | 36 | 310 | 93 | 45 | Class I |
| REF3.0.N.258 | 2-5/8" | 3530 | 66,8 | 36 | 310 | 93 | 45 | Class I |
| REF3.0.N.076 | 76mm (3") | 6100 | 76,1 | 36 | 362 | 118 | 45 | Class I |
| REF3.0.N.080 | 80mm (3-1/8") | 6100 | 80,0 | 36 | 362 | 118 | 45 | Class I |

W: Reduced Port

N: standard spring valve with minimum Opening Pressure Differential =0,1 bar

R: reinforced spring valve with minimum Opening Pressure Differential =0,3 bar

 The changeover is a service device for safety valves that allows using one valve while isolating the other from the system. The valve ensures a pressure drop compatible with the safety valve operation under condition of discharge of saturated or overheated vapour.

 La valvola deviatrice è un rubinetto di servizio tra due valvole di sicurezza che esclude alternativamente l'una o l'altra permettendo interventi sull'impianto. Il rubinetto assicura una caduta di pressione compatibile con il funzionamento dei dispositivi di sicurezza in condizioni di scarico sia di vapore saturo che di vapore surriscaldato.

 Das Umleitventil ist ein Sperrhahn zwischen zwei Sicherheitsventilen, der abwechselnd das eine oder andere ausschließt und damit Eingriffe an der Anlage erlaubt. Der Hahn sichert einen Druckabfall, der mit dem Betrieb der Sicherheitsvorrichtungen sowohl bei Ableitung von gesättigtem als auch von überhitztem Dampf kompatibel ist.

 La vanne d'échange sert de robinet de service entre deux vannes de sécurité, en permettant simultanément l'utilisation de l'une et l'exclusion de l'autre. La vanne assure une chute de pression parfaitement compatible avec le fonctionnement du dispositif de sécurité des conditions d'évacuation, aussi bien de la vapeur saturée que de la vapeur de surchauffe.

 Las válvula de desviación es una llave de paso de servicio entre dos válvulas de seguridad que excluye alternativamente o una o la otra, permitiendo intervenciones en la instalación. Esta llave de paso asegura la caída de presión compatible con el funcionamiento de los dispositivos de seguridad en condiciones de descarga ya sea de vapor saturado que de vapor sobrecalentado.

 A válvula de desviadora é um registro de serviço entre duas válvulas de segurança que exclui alternadamente uma ou outra, isto para permitir de efetuar operações na instalação. O registro garante uma queda de pressão compatível com o funcionamento dos dispositivos de segurança em condições de descarregar, tanto o vapor saturado como o vapor superaquecido.

 チェンジオーバーは、ひとつのバルブを使用しながら他をシステムよりアイソレートすることを可能にする、セーフティー・バルブのためのサービス・デバイスです。同バルブは、サチュレートもしくはオーバーヒートした蒸気のディスチャージ、という条件下でのセーフティー・バルブ・オペレーションと互換性のあるブレッシャー・ドロップを、確保します。

 Перекидной клапан - вспомогательный кран между двумя предохранительными клапанами, который поочередно отключает один или другой клапан, позволяя, таким образом, производить вмешательство на установке. Кран обеспечивает падение давления, соответствующее функционированию предохранительных устройств при условиях выпуска, как насыщенного, так и перегретого пара.

3Way Changeover Valve

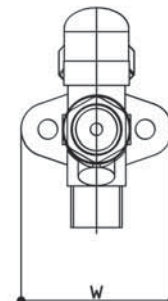
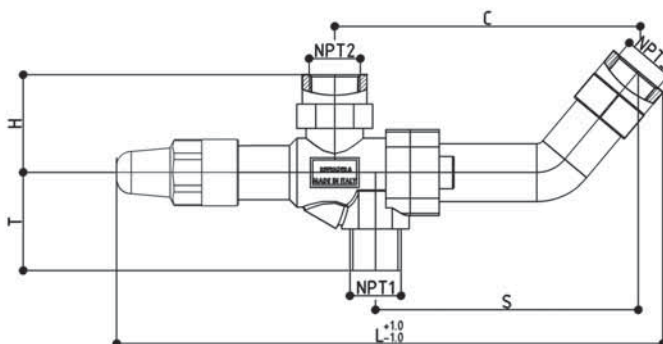
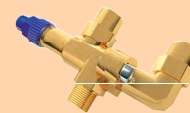



| Code | Connection NPT1 | Conn NPT2 | Conn NPT3 | Length | Height | T | Wide | S | Kv | WTemp | P.E.D. |
|--------------------|-----------------|-----------|-----------|--------|--------|--------|--------|--------|--|-----------|---------------|
| REF | inches | inches | inches | L (mm) | H (mm) | C (mm) | W (mm) | S (mm) | $\Delta P: 1 \text{ bar}$ (m ³ /h) | °C | Group2 fluids |
| REF2.0.012.012.012 | 1/2" | 1/2" | 1/2" | 164 | 85 | 70 | 62 | 53,5 | 1,0 | -40/ +150 | Art.3.3 |





THE IMAGE SHOWS: NPT valve could be mounted to stop excessive gas-discharge in case of safety device's intervention.

 Our bi-flow system allows the NPT Valves suitable to be used together with safety valve of the same Nominal Diameter.

 Le valvole NPT sono adatte per essere utilizzate assieme alle valvole di sicurezza dello stesso diametro nominale.

 Die NPT-Ventile eignen sich für den Einsatz zusammen mit Sicherheitsventilen des gleichen Nenndurchmessers.

 Les vannes NPT sont appropriées pour être utilisées avec les vannes de sécurité du même diamètre nominal.

 Las válvulas NPT están adaptadas para ser utilizadas junto a las válvulas de seguridad del mismo diámetro nominal.

 As válvulas NPT são apropriadas para serem utilizadas junto com as válvulas de segurança com o mesmo diâmetro nominal.

 弊社バイ・フロー・システムは、適切なNPTバルブが、同じ名目直径のセーフティー・バルブと一緒に使用されることを可能にします。

 Клапаны NPT предназначены для использования вместе с предохранительными клапанами с таким же номинальным диаметром.

NPT Ball Valve

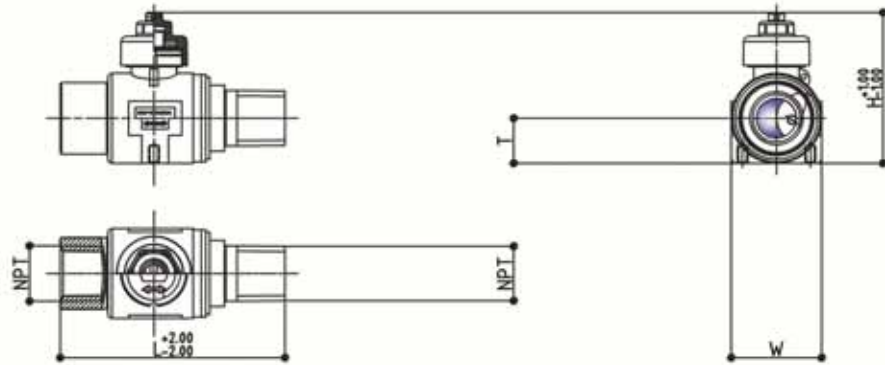



| Code | Connection | Weight | Sphere passage | Length | Height | Wide | V | T | Kv | WTemp | P.E.D. |
|--------------------|------------|--------|----------------|--------|--------|--------|--------|--------|----------------|-----------|---------------|
| REF | DN | (g) | Ø(mm) | L (mm) | H (mm) | W (mm) | V (mm) | T (mm) | ΔP:1bar (m³/h) | °C | Group2 fluids |
| REF1.0.P.B.012.1.N | 1/2" | 360 | 15 | 85 | 56,5 | 34 | 24 | 17 | 13 | -40/ +150 | Art.3.3 |
| REF1.0.P.C.001.1.N | 1" | 890 | 19 | 120 | 85 | 46 | 35 | 26 | 24 | | Art.3.3 |





THE IMAGE SHOWS: Safety devices mounted in twin configuration in order to keep the plant safe in case of replacement of one of them, after its intervention.

 Completely made of brass, safety valves grant protection against possible overpressures of the refrigerating systems with regards to the operating conditions for which they have been designed.

 Interamente realizzate in ottone, le valvole di sicurezza garantiscono protezione contro eventuali sovrappressioni, rispetto alle condizioni di esercizio di progetto, delle componenti di sistemi di refrigerazione o condizionamento.

 Die Sicherheitsventile sind ganz aus Messing gefertigt und schützen unter normalen Betriebsbedingungen vor Überdruck in den Bauteilen der Kühl- oder Klimatisierungssysteme.

 Entièrement réalisées en laiton, les vannes de sécurité garantissent une protection contre les surpressions éventuelles, par rapport aux conditions de service pour lesquelles elles ont été conçues, dans les composants de systèmes de réfrigération.

 Totalmente realizadas en bronce, las válvulas de seguridad garantizan protección contra eventuales golpes de presión, con respecto a las condiciones de sistemas de refrigeración o acondicionamiento.

 Inteiramente produzidas em latão, as válvulas de segurança garantem proteção contra quaisquer excesso de pressão, em relação às condições de exercício estabelecidas no projeto, dos componentes dos sistemas de refrigeração ou do condicionamento do ar.

 セーフティー・バルブは、完全に brass で作られており、これらがその為に設計されたところのオペレーション・コンディションに関連する、起こり得るリフリジレーティング・システムのオーバープレッシャーに対するプロテクションを、提供します。

 Предохранительные клапаны, полностью выполненные из латуни, гарантируют защиту от возможного избыточного давления, по сравнению с проектными условиями эксплуатации.

Safety Valve



SCARICO LIBERO
FREE OUTLET

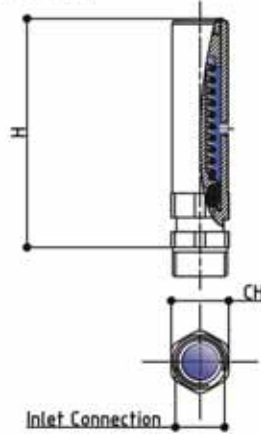

SCARICO CONVOGLIATO
PIPED OUTLET

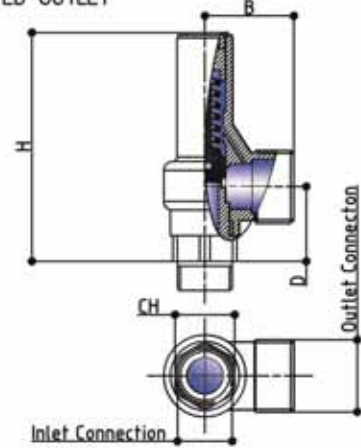



| Code | ID | Flow Diam. | H | D | B | CH | Inlet Conn. | Outlet Conn. | Setting | PN | Kv $\Delta P=1\text{bar}$ |
|---|--------|---------------|-----|------|----|----|----------------|-----------------|---------|-----|------------------------------|
| | | mm | mm | mm | mm | mm | NPT | GAS | bar | bar | m ³ /h |
| PRESSURE SETTINGS RANGE 0÷60 BAR | | | | | | | | | | | |
| REF80.14.00.07.xxx | D7/S | 7 | 53 | - | - | 20 | 1/4" | FREE | 0÷60 | 40 | 0,58 |
| REF80.38.00.07.xxx | D7/S | 7 | 53 | - | - | 20 | 3/8" | FREE | 0÷60 | 40 | 0,58 |
| REF80.38.00.10.xxx | D10/S | 10 | 62 | - | - | 23 | 3/8" | FREE | 0÷60 | 40 | 0,65 |
| REF80.12.00.10.xxx | D10/S | 10 | 62 | - | - | 23 | 1/2" | FREE | 0÷60 | 40 | 0,65 |
| REF80.14.12.07.xxx | D7/CS | 7 | 71 | 23,5 | 29 | 22 | 1/4" | 1/2" | 0÷60 | 60 | 0,58 |
| REF80.38.12.07.xxx | D7/CS | 7 | 71 | 23,5 | 29 | 22 | 3/8" | 1/2" | 0÷60 | 60 | 0,58 |
| REF80.38.34.10.xxx | D10/CS | 10 | 88 | 30 | 32 | 25 | 3/8" | 3/4" | 0÷60 | 60 | 0,77 |
| REF80.12.34.10.xxx | D10/CS | 10 | 88 | 30 | 32 | 25 | 1/2" | 3/4" | 0÷60 | 60 | 0,77 |
| REF80.12.01.14.xxx | G14/S | 13,5 | 134 | 33 | 49 | 30 | 1/2" | 1" | 0÷60 | 60 | 0,81 |
| REF80.34.01.14.xxx | G14/S | 13,5 | 134 | 33 | 49 | 30 | 3/4" | 1" | 0÷60 | 60 | 0,81 |
| REF80.01.01.14.xxx | G14/S | 13,5 | 134 | 33 | 49 | 30 | 1" | 1" | 0÷60 | 60 | 0,81 |
| REF80.01.11.20.xxx | G20/S | 20 | 168 | 40 | 59 | 40 | 1" | 1-1/4" | 0÷60 | 60 | 0,82 |
| REF80.11.11.20.xxx | G20/S | 20 | 168 | 40 | 59 | 40 | 1-1/4" | 1-1/4" | 0÷60 | 60 | 0,82 |





THE IMAGE SHOWS: Hot forged brass Safety Valve

 Completely made of brass, REFRIGERA valves have the peculiar value to be provided with copper tube and INOX stem that assure easy torch-brazing with the normal filler metals for Cu to Cu joint and, on the other hand, corrosion resistance of all parts.

 Interamente realizzate in ottone, le valvole REFRIGERA hanno la peculiare caratteristica di essere provviste di tronchetti a saldare in rame e perno in acciaio INOX, permettendo, da un lato, il perfetto accoppiamento mediante brasatura a cannello con le consuete leghe rame fosforo e garantendo, dall'altro, l'inalterabilità nel tempo di tutte le parti.

 Die Ventile REFRIGERA sind ganz aus Messing hergestellt und haben als besonderes Merkmal Einschweißstutzen aus Kupfer und Zapfen aus EDELSTAHL, dies ermöglicht auf einer Seite eine perfekte Verbindung durch Hartlöten mit den herkömmlichen Kupfer-Phosphor-Legierungen und garantiert auf der anderen, die langfristige Haltbarkeit aller Teile.

 Entièrement réalisées en laiton, Les vannes Rotalock REFRIGERA ont la caractéristique d'être pourvues des connexions à souder en cuivre avec le pivot en INOX. Grâce à cette particularité, sur une partie, la brasure avec les habituels alliages (pour la jonction Cu-Cu) est plus rapide et facile, et sur l'autre partie, le type de matériel préserve la vanne des éventuels problèmes de corrosion.

 Totalmente realizadas en bronce, las válvulas REFRIGERA tienen la particularidad de estar provistas de pequeños troncos soldados en cobre y con perno de acero INOX, permitiendo por un lado, el perfecto acoplamiento mediante soldadura con soplete con las habituales de cobre fósforo y garantizando, por otra parte, la inalterabilidad en el tiempo de todas las partes.

 Inteiramente produzidas em latão, as válvulas REFRIGERA apresentam uma característica peculiar pois dispõem, de soquetes soldados com cobre e pino de aço INOX, o que permite, de um lado, o perfeito acoplamento mediante brasagem com maçarico e as habituais ligas de cobre e fósforo e por outro lado, assegura a inalterabilidade de todos os componentes no decorrer do tempo.

 レフリジェラ・バルブは、完全にブラスで作られており、提供されるべき、優れた価値を保持します。コッパー・チューブとINOXステムが伴い、最小限のフィラー・メタルによるCuとCuジョイントの、簡潔なトーチ・ブレイジングを確実にし、またその一方で、すべてのパーツは耐侵食性を誇ります。

 Клапаны REFRIGERA, полностью реализованные из латуни, обладают особой характеристикой наличия привариваемых медных патрубков и стержня из нержавеющей стали, обеспечивая, с одной стороны, превосходное соединение посредством газопламенной пайки с обычными сплавами меди и фосфора, и гарантируя, с другой стороны, неизменяемость всех компонентов по истечении времени.

Brass Rotalock Valve

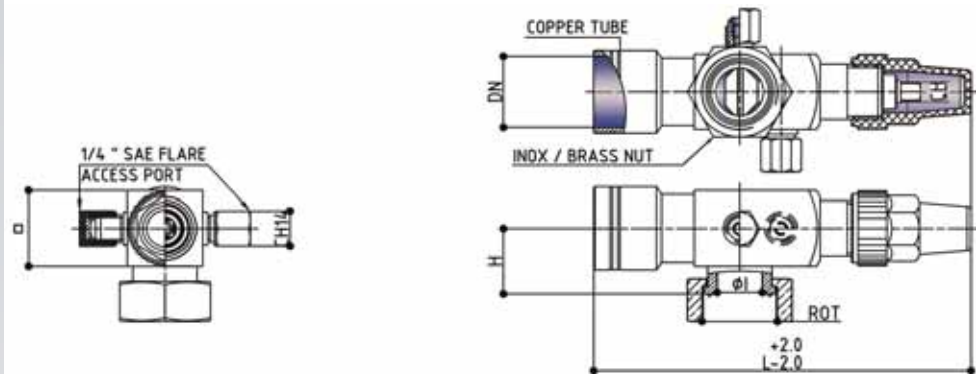



| Code | ODS | Connection | NUT | Weight | Length | Spanner | H | □ | ØI | Kv | WTemp | P.E.D. |
|-----------------|-------------|------------|--------|--------|--------|---------|------|------|------|----------------|-----------|---------------|
| REF | DN | Ø | ROT | (g) | L (mm) | CH(mm) | (mm) | (mm) | (mm) | ΔP:1bar (m³/h) | °C | Group2 fluids |
| REF22.42.20.006 | 6mm | 6,1 | 1" | 258 | 108 | 6,35 | 23 | 20 | 12 | 0,41 | | Art.3.3 |
| REF22.42.20.014 | 1/4" | 6,4 | 1" | 258 | 108 | 6,35 | 23 | 20 | 12 | 0,41 | | Art.3.3 |
| REF22.42.20.010 | 10mm | 10,2 | 1" | 268 | 108 | 6,35 | 23 | 20 | 12 | 1,63 | | Art.3.3 |
| REF22.42.20.038 | 3/8" | 9,7 | 1" | 268 | 108 | 6,35 | 23 | 20 | 12 | 1,63 | | Art.3.3 |
| REF22.42.20.012 | 12mm | 12,2 | 1" | 272 | 108 | 6,35 | 23 | 20 | 12 | 2,36 | | Art.3.3 |
| REF22.42.20.127 | 1/2" | 12,8 | 1" | 272 | 108 | 6,35 | 23 | 20 | 12 | 2,36 | | Art.3.3 |
| REF22.42.20.016 | 16mm 5/8" | 16,2 | 1" | 284 | 108 | 6,35 | 23 | 20 | 12 | 3,39 | | Art.3.3 |
| REF22.42.20.018 | 18mm | 18,2 | 1" | 284 | 112 | 6,35 | 23 | 20 | 12 | 3,11 | | Art.3.3 |
| REF22.42.20.034 | 3/4" | 19,3 | 1" | 292 | 112 | 6,35 | 23 | 20 | 12 | 3,11 | | Art.3.3 |
| REF22.42.20.022 | 22mm 7/8" | 22,3 | 1" | 292 | 112 | 6,35 | 23 | 20 | 12 | 3,00 | | Art.3.3 |
| REF22.43.22.010 | 10mm | 10,2 | 1-1/4" | 314 | 110 | 6,35 | 24 | 22 | 13 | 1,63 | | Art.3.3 |
| REF22.43.22.038 | 3/8" | 9,7 | 1-1/4" | 320 | 110 | 6,35 | 24 | 22 | 13 | 1,63 | | Art.3.3 |
| REF22.43.22.012 | 12mm | 12,2 | 1-1/4" | 320 | 110 | 6,35 | 24 | 22 | 13 | 2,31 | | Art.3.3 |
| REF22.43.22.127 | 1/2" | 12,8 | 1-1/4" | 320 | 110 | 6,35 | 24 | 22 | 13 | 2,31 | | Art.3.3 |
| REF22.43.22.016 | 16mm 5/8" | 16,2 | 1-1/4" | 320 | 112 | 6,35 | 24 | 22 | 13 | 3,36 | | Art.3.3 |
| REF22.43.22.018 | 18mm | 18,2 | 1-1/4" | 335 | 112 | 6,35 | 24 | 22 | 13 | 3,84 | | Art.3.3 |
| REF22.43.22.034 | 3/4" | 19,3 | 1-1/4" | 335 | 112 | 6,35 | 24 | 22 | 13 | 3,46 | | Art.3.3 |
| REF22.43.30.018 | 18mm | 18,2 | 1-1/4" | 515 | 140 | 8,00 | 27 | 30 | 19 | 6,65 | | Art.3.3 |
| REF22.43.30.034 | 3/4" | 19,3 | 1-1/4" | 515 | 140 | 8,00 | 27 | 30 | 19 | 6,65 | -40/ +150 | Art.3.3 |
| REF22.43.30.022 | 22mm 7/8" | 22,3 | 1-1/4" | 535 | 142 | 8,00 | 27 | 30 | 19 | 10,19 | | Art.3.3 |
| REF22.43.30.028 | 28mm | 28,2 | 1-1/4" | 535 | 150 | 8,00 | 27 | 30 | 19 | 10,53 | | Art.3.3 |
| REF22.43.30.118 | 1-1/8" | 28,8 | 1-1/4" | 535 | 150 | 8,00 | 27 | 30 | 19 | 10,53 | | Art.3.3 |
| REF22.44.30.018 | 18mm | 18,2 | 1-3/4" | 650 | 145 | 8,00 | 27 | 30 | 19 | 6,58 | | Art.3.3 |
| REF22.44.30.034 | 3/4" | 19,3 | 1-3/4" | 650 | 145 | 8,00 | 27 | 30 | 19 | 6,58 | | Art.3.3 |
| REF22.44.30.022 | 22mm 7/8" | 22,3 | 1-3/4" | 600 | 145 | 8,00 | 27 | 30 | 19 | 10,12 | | Art.3.3 |
| REF22.44.30.028 | 28mm | 28,2 | 1-3/4" | 614 | 150 | 8,00 | 27 | 30 | 19 | 11,34 | | Art.3.3 |
| REF22.44.30.118 | 1-1/8" | 28,8 | 1-3/4" | 614 | 150 | 8,00 | 27 | 30 | 19 | 11,34 | | Art.3.3 |
| REF22.44.35.028 | 28mm | 28,2 | 1-3/4" | 614 | 165 | 9,60 | 31 | 35 | 24 | 11,74 | | Art.3.3 |
| REF22.44.35.118 | 1-1/8" | 28,8 | 1-3/4" | 792 | 165 | 9,60 | 31 | 35 | 24 | 11,74 | | Art.3.3 |
| REF22.44.35.035 | 35mm 1-3/8" | 35,2 | 1-3/4" | 792 | 170 | 9,60 | 31 | 35 | 24 | 15,58 | | Class I |
| REF22.44.35.042 | 42mm | 42,2 | 1-3/4" | 814 | 170 | 9,60 | 31 | 35 | 24 | 13,00 | | Class I |
| REF22.44.35.158 | 1-5/8" | 41,5 | 1-3/4" | 928 | 170 | 9,60 | 31 | 35 | 24 | 13,00 | | Class I |
| REF22.45.50.035 | 35mm 1-3/8" | 35,2 | 2-1/4" | 1620 | 200 | 9,60 | 36 | 50 | 39 | 25,45 | | Class I |
| REF22.45.50.042 | 42mm | 42,2 | 2-1/4" | 1650 | 200 | 9,60 | 36 | 50 | 39 | 33,08 | | Class I |
| REF22.45.50.158 | 1-5/8" | 41,5 | 2-1/4" | 1650 | 200 | 9,60 | 36 | 50 | 39 | 33,08 | | Class I |
| REF22.45.50.054 | 54mm 2-1/8" | 54,3 | 2-1/4" | 1690 | 200 | 9,60 | 36 | 50 | 39 | 31,24 | | Class I |

 REFRIGERA rotalock have the peculiar value to be provided with copper tube and INOX or brass nut that assure easy torch-brazing with the normal filler metals for Cu to Cu joint and, on the other hand, corrosion resistance of all parts.

 I rotalock REFRIGERA hanno la peculiare caratteristica di essere provvisti di tronchetti a saldare in rame e girello in ottone o acciaio INOX permettendo, da un lato, il perfetto accoppiamento mediante brasatura a cannello con le consuete leghe rame fosforo e garantendo, dall'altro, l'inalterabilità nel tempo di tutte le parti.

 Die Rotalock REFRIGERA haben als besonderes Merkmal Einschweißstutzen aus Kupfer und eine Flügelmutter aus Messing oder Edelstahl, dies ermöglicht auf einer Seite eine perfekte Verbindung durch Hartlöten mit den herkömmlichen Kupfer-Phosphor-Legierungen und garantiert auf der anderen, die langfristige Haltbarkeit aller Teile.

 Les Rotalock REFRIGERA ont la caractéristique d'être pourvues des connexions à souder en cuivre et l'écrou en laiton ou en INOX. Grâce à cette particularité, sur une partie, la brasure avec les habituels alliages (pour la jonction Cu-Cu) est plus rapide et facile, et sur l'autre partie, le type de matériel préserve la vanne des éventuels problèmes de corrosion.

 El rotalock REFRIGERA tiene la característica de estar provistos de troncos soldados en cobre y roscas en bronce o acero INOX permitiendo, por un lado, un perfecto acoplamiento mediante soldadura con soplete con las habituales aleaciones de cobre fósforo y garantizando, por otra parte, la inalterabilidad en el tiempo de todas las partes.

 Os Rotalock REFRIGERA apresentam uma característica peculiar pois dispõem, de soquetes soldados com cobre e porca de latão ou de aço INOX, o que permite, de um lado, o perfeito acoplamento mediante brasagem com maçarico e as habituais ligas de cobre e fósforo e por outro lado, assegura a inalterabilidade de todos os componentes no decorrer do tempo.

 レフリジェラ・ロタロックは、提供されるべき、優れたバリューを保持します。これらには、コップ・チューブ、INOXもしくはブラス・ナットが伴い、最小限のフィラー・メタルによるCuとCuジョイントの、簡潔なトーチ・ブレイジングを確実にし、またその一方で、すべてのパーツは耐侵食性を誇ります。

 Rotalock REFRIGERA обладают особой характеристикой наличия привариваемых медных патрубков и гайки из латуни или нержавеющей стали, обеспечивая, с одной стороны, превосходное соединение посредством газопламенной пайки с обычными сплавами меди и фосфора, и гарантируя, с другой стороны, неизменяемость всех компонентов по истечению времени.

Brass Rotalock Straight Adapter

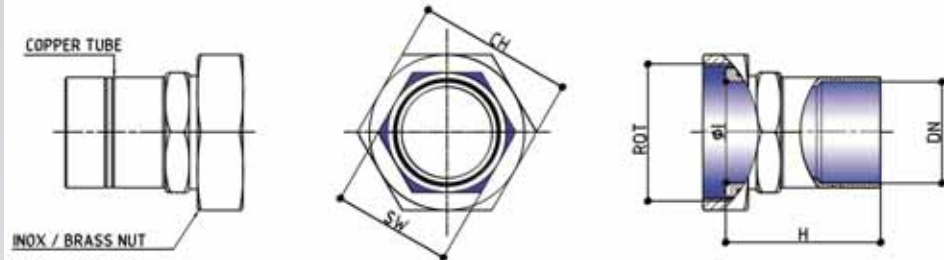
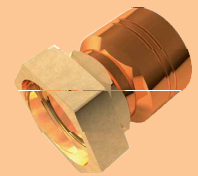



| Code | Rotalock Connection | ODS | Connection | Weight | H | SW1 | CH | Ø1 | P.E.D. |
|-------------------------|---------------------|--------------|------------|-------------|------|------|------|------|---------------|
| REF | ROT | DN | Ø | (g) | (mm) | (mm) | (mm) | (mm) | Group2 fluids |
| ROTALOCK 1" - 14UNF | | | | (INOX NUT) | | | | | |
| REF32.02.00.010 | 1" - 14UNS | 10 mm | 10,2 | 106 | 31,5 | 22 | 30 | 18 | Art.3.3 |
| REF32.02.00.038 | 1" - 14UNS | 3/8" | 9,7 | 106 | 31,5 | 22 | 30 | 18 | Art.3.3 |
| REF32.02.00.012 | 1" - 14UNS | 12 mm | 12,2 | 108 | 31,5 | 22 | 30 | 18 | Art.3.3 |
| REF32.02.00.127 | 1" - 14UNS | 1/2" | 12,8 | 108 | 31,5 | 22 | 30 | 18 | Art.3.3 |
| REF32.02.00.016 | 1" - 14UNS | 16 mm 5/8" | 16,2 | 112 | 31,5 | 22 | 30 | 18 | Art.3.3 |
| REF32.02.00.018 | 1" - 14UNS | 18 mm | 18,2 | 114 | 31,5 | 22 | 30 | 18 | Art.3.3 |
| REF32.02.00.034 | 1" - 14UNS | 3/4" | 19,3 | 114 | 31,5 | 22 | 30 | 18 | Art.3.3 |
| REF32.02.00.022 | 1" - 14UNS | 22 mm 7/8" | 22,3 | 116 | 31,5 | 22 | 30 | 18 | Art.3.3 |
| ROTALOCK 1-1/4" - 12UNF | | | | (INOX NUT) | | | | | |
| REF32.03.00.016 | 1-1/4" - 12UNF | 16 mm 5/8" | 16,2 | 162 | 42,5 | 27 | 35 | 18 | Art.3.3 |
| REF32.03.00.018 | 1-1/4" - 12UNF | 18 mm | 18,2 | 170 | 42,5 | 27 | 35 | 18 | Art.3.3 |
| REF32.03.00.034 | 1-1/4" - 12UNF | 3/4" | 19,3 | 250 | 42,5 | 27 | 35 | 18 | Art.3.3 |
| REF32.03.00.022 | 1-1/4" - 12UNF | 22 mm 7/8" | 22,3 | 272 | 42,5 | 27 | 35 | 18 | Art.3.3 |
| REF32.03.00.028 | 1-1/4" - 12UNF | 28 mm | 28,2 | 296 | 42,5 | 36 | 35 | 18 | Art.3.3 |
| REF32.03.00.118 | 1-1/4" - 12UNF | 1-1/8" | 28,2 | 296 | 42,5 | 36 | 35 | 18 | Art.3.3 |
| ROTALOCK 1-3/4" - 12UN | | | | (BRASS NUT) | | | | | |
| REF32.04.00.022 | 1-3/4" - 12UN | 22 mm 7/8" | 22,3 | 280 | 51,5 | 36 | 50 | 26 | Art.3.3 |
| REF32.04.00.028 | 1-3/4" - 12UN | 28 mm | 28,2 | - | 51,5 | 36 | 50 | 26 | Art.3.3 |
| REF32.04.00.118 | 1-3/4" - 12UN | 1-1/8" | 28,8 | - | 51,5 | 36 | 50 | 26 | Art.3.3 |
| REF32.04.00.035 | 1-3/4" - 12UN | 1-3/8" | 35,2 | - | 51,5 | 36 | 50 | 26 | Class I |
| REF32.04.00.042 | 1-3/4" - 12UN | 42 mm | 42,2 | - | 51,5 | 36 | 50 | 26 | Class I |
| REF32.04.00.158 | 1-3/4" - 12UN | 1-5/8" | 41,5 | - | 51,5 | 36 | 50 | 26 | Class I |
| ROTALOCK 2-1/4" - 12UN | | | | (BRASS NUT) | | | | | |
| REF32.05.00.042 | 2-1/4" - 12UN | 42 mm | 42,2 | 942 | 61,5 | 50 | 65 | 38 | Class I |
| REF32.05.00.158 | 2-1/4" - 12UN | 1-5/8" | 41,5 | - | 61,5 | 50 | 65 | 38 | Class I |
| REF32.05.00.054 | 2-1/4" - 12UN | 54 mm 2-1/8" | 54,3 | - | 67,5 | 50 | 65 | 38 | Class I |

 Completely made of brass, REFRIGERA rotalock have the peculiar value to be provided with copper tube and INOX or brass nut that assure easy torch-brazing with the normal filler metals for Cu to Cu joint and, on the other hand, corrosion resistance of all parts.

 Interamente realizzati in ottone, i rotalock REFRIGERA hanno la peculiare caratteristica di essere provvisti di tronchetti a saldare in rame e girello in ottone o acciaio INOX permettendo, da un lato, il perfetto accoppiamento mediante brasatura a cannello con le consuete leghe rame fosforo e garantendo, dall'altro, l'inalterabilità nel tempo di tutte le parti.

 Die Rotalock REFRIGERA haben als besonderes Merkmal Einschweißstutzen aus Kupfer und eine Flügelmutter aus Messing oder Edelstahl, dies ermöglicht auf einer Seite eine perfekte Verbindung durch Hartlöten mit den herkömmlichen Kupfer-Phosphor-Legierungen und garantiert auf der anderen, die langfristige Haltbarkeit aller Teile.

 Les Rotalock REFRIGERA ont la caractéristique d'être pourvues des connexions à souder en cuivre et l'écrou en laiton ou en INOX. Grâce à cette particularité, sur une partie, la brasure avec les habituels alliages (pour la jonction Cu-Cu) est plus rapide et facile, et sur l'autre partie, le type de matériel préserve la vanne des éventuels problèmes de corrosion.

 El rotalock REFRIGERA tiene la característica de estar provistos de troncos soldados con cobre y roscas en bronce o acero INOX permitiendo, por un lado, un perfecto acoplamiento mediante soldadura con soplete con las habituales aleaciones de cobre fósforo y garantizando, por otra parte, la inalterabilidad en el tiempo de todas las partes.

 Os Rotalock REFRIGERA apresentam uma característica peculiar pois dispõem, de soquetes soldados com cobre e porca de latão ou de aço INOX, o que permite, de um lado, o perfeito acoplamento mediante brasagem com maçarico e as habituais ligas de cobre e fósforo e por outro lado, assegura a inalterabilidade de todos os componentes no decorrer do tempo.

 レフリジェラ・ロタロックは、提供されるべき、優れたバリューを保持します。これらには、コッパ・チューブ、INOXもしくははブラス・ナットが伴い、最小限のフィラー・メタルによるCu と Cu ジョイントの、簡潔なトーチ・ブレイジングを確実にし、またその一方で、すべてのパーツは耐侵食性を誇ります。

 Rotalock REFRIGERA, полностью реализованные из латуни, обладают особой характеристикой наличия привариваемых медных патрубков и гайки из латуни или нержавеющей стали, обеспечивая, с одной стороны, превосходное соединение посредством газопламенной пайки с обычными сплавами меди и фосфора, и гарантируя, с другой стороны, неизменяемость всех компонентов по истечении времени.

Brass Rotalock Angle Adapter

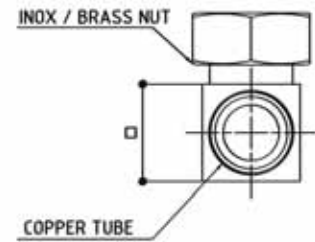
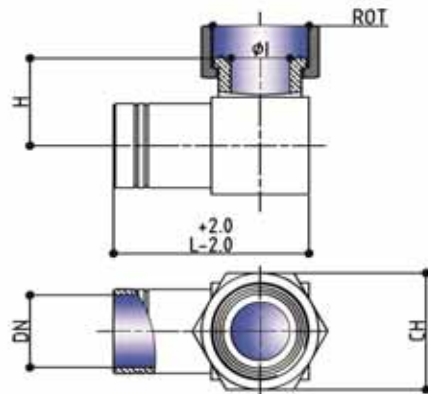
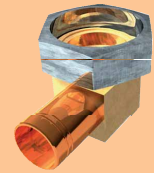



| Code | Rotalock Connection | ODS | Connection | Weight | Length | Spanner | H | □ | ØI | P.E.D. | |
|------------------------|---------------------|------------|------------|--------|-------------|---------|------|------|------|---------------|--|
| REF | ROT | DN | Ø | (g) | L | CH | (mm) | (mm) | (mm) | Group2 fluids | |
| ROTALOCK 1" - 14UNF | | | | | (INOX NUT) | | | | | | |
| REF42.02.20.010 | 1"-14UNS | 10 mm | 10,2 | 70 | 40 | 30 | 31,5 | 20 | 12 | Art.3.3 | |
| REF42.02.20.038 | 1"-14UNS | 3/8" | 9,7 | 72 | 40 | 30 | 31,5 | 20 | 12 | Art.3.3 | |
| REF42.02.20.012 | 1"-14UNS | 12 mm | 12,2 | 72 | 40 | 30 | 31,5 | 20 | 12 | Art.3.3 | |
| REF42.02.20.127 | 1"-14UNS | 1/2" | 12,8 | 76 | 40 | 30 | 31,5 | 20 | 12 | Art.3.3 | |
| REF42.02.20.016 | 1"-14UNS | 16 mm 5/8" | 16,2 | 76 | 40 | 30 | 31,5 | 20 | 12 | Art.3.3 | |
| REF42.02.20.018 | 1"-14UNS | 18 mm | 18,2 | 124 | 40 | 30 | 31,5 | 20 | 12 | Art.3.3 | |
| REF42.02.20.034 | 1"-14UNS | 3/4" | 19,3 | 124 | 40 | 30 | 31,5 | 20 | 12 | Art.3.3 | |
| REF42.02.20.022 | 1"-14UNS | 22 mm 7/8" | 22,3 | 124 | 40 | 30 | 31,5 | 20 | 12 | Art.3.3 | |
| ROTALOCK 1-1/4" -12UNF | | | | | (INOX NUT) | | | | | | |
| REF42.03.22.016 | 1-1/4"-12UNF | 16 mm 5/8" | 16,2 | 124 | 55 | 35 | 42,5 | 22 | 20 | Art.3.3 | |
| REF42.03.30.018 | 1-1/4"-12UNF | 18 mm | 18,2 | 126 | 55 | 35 | 42,5 | 30 | 20 | Art.3.3 | |
| REF42.03.30.034 | 1-1/4"-12UNF | 3/4" | 19,3 | 126 | 55 | 35 | 42,5 | 30 | 20 | Art.3.3 | |
| REF42.03.30.022 | 1-1/4"-12UNF | 22 mm 7/8" | 22,3 | 124 | 55 | 35 | 42,5 | 30 | 20 | Art.3.3 | |
| REF42.03.30.028 | 1-1/4"-12UNF | 28 mm | 28,2 | 160 | 55 | 35 | 42,5 | 30 | 20 | Art.3.3 | |
| REF42.03.30.118 | 1-1/4"-12UNF | 1-1/8" | 28,2 | 160 | 55 | 35 | 42,5 | 30 | 20 | Art.3.3 | |
| ROTALOCK 1-3/4" -12UN | | | | | (BRASS NUT) | | | | | | |
| REF42.04.35.028 | 1-3/4"-12UN | 28 mm | 28,2 | 230 | 68 | 50 | 51,5 | 35 | 30 | Art.3.3 | |
| REF42.04.35.118 | 1-3/4"-12UN | 1-1/8" | 28,8 | 242 | 68 | 50 | 51,5 | 35 | 30 | Art.3.3 | |
| REF42.04.35.035 | 1-3/4"-12UN | 1-3/8" | 35,2 | 296 | 68 | 50 | 51,5 | 35 | 30 | Class I | |
| REF42.04.35.042 | 1-3/4"-12UN | 42 mm | 42,2 | 312 | 68 | 50 | 51,5 | 35 | 30 | Class I | |
| REF42.04.35.158 | 1-3/4"-12UN | 1-5/8" | 41,5 | 312 | 68 | 50 | 51,5 | 35 | 30 | Class I | |
| ROTALOCK 2-1/4"—12UN | | | | | (BRASS NUT) | | | | | | |
| REF42.05.50.035 | 2-1/4"-12UN | 35 mm | 42,2 | 450 | 86 | 65 | 61,5 | 50 | 40 | Class I | |
| REF42.05.50.042 | 2-1/4"-12UN | 42 mm | 41,5 | 494 | 86 | 65 | 61,5 | 50 | 40 | Class I | |
| REF42.05.50.158 | 2-1/4"-12UN | 1-5/8" | 54,3 | 494 | 86 | 65 | 67,5 | 50 | 40 | Class I | |
| REF42.05.50.054 | 2-1/4"-12UN | 2-1/8" | 54,3 | 556 | 86 | 65 | 67,5 | 50 | 40 | Class I | |

 Completely made of carbon steel, REFRIGERA valves have the peculiar value to be provided with stainless steel stem that assure easy welding and corrosion resistance of all parts.

 Interamente realizzate in acciaio, le valvole REFRIGERA hanno la peculiare caratteristica di essere provviste di perno in acciaio, garantendo l'inalterabilità nel tempo di tutte le parti.

 Die Ventile REFRIGERA sind ganz aus Edelstahl hergestellt und haben als besonderes Merkmal Zapfen aus EDELSTAHL, dies garantiert die langfristige Haltbarkeit aller Teile.

 Entièrement réalisées en acier, Les vannes REFRIGERA ont la caractéristique d'être pourvues de pivot en acier inoxydable. Grâce à cette particularité le type de matériel préserve la vanne des éventuels problèmes de corrosion.

 Totalmente realizadas en acero, las válvulas REFRIGERA tienen la particularidad de estar provistas de perno de acero INOX garantizando la inalterabilidad en el tiempo de todas las partes.

 Inteiramente produzidas em aço, as válvulas REFRIGERA apresentam uma característica peculiar pois dispõem, de pino de aço INOX, o que assegura a inalterabilidade de todos os componentes no decorrer do tempo.

 レフリジェラ・バルブは、に球状鋳鉄製提供されるべき、優れた価値を保持します。・とINOXシステムが伴い、最小限のフィルター・メタルによるジョイントの、簡潔なトーチ・ブレイジングを確実にし、またその一方で、すべてのパーツは耐侵食性を誇ります。

 Клапаны REFRIGERA полностью реализованы из чугуна с стали. палец из нержавеющей стали гарантируют хорошую сварку и сопротивление коррозии.

Nickel Coated Rotalock Valve

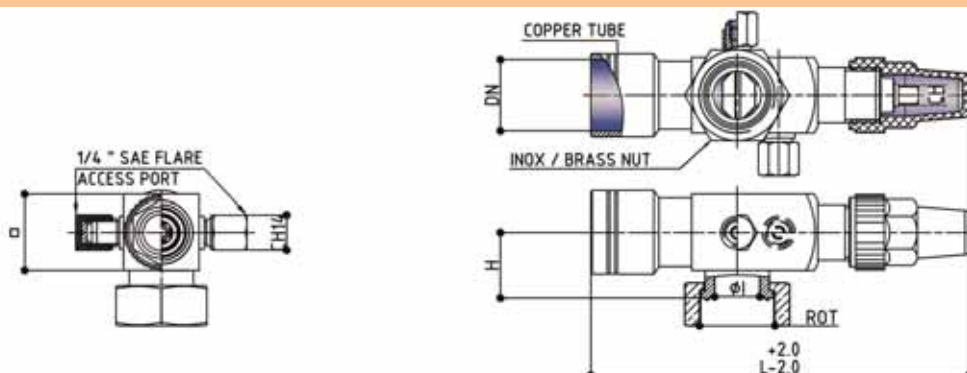



| Code | ODS | Connection | NUT | Weight | Length | Spanner | H | □ | ØI | Kv | WTemp | P.E.D. |
|-----------------|-------------|------------|--------|--------|--------|---------|------|------|------|----------------|-----------|---------------|
| REF | DN | Ø | ROT | (g) | L (mm) | CH(mm) | (mm) | (mm) | (mm) | ΔP:1bar (m³/h) | °C | Group2 fluids |
| REF24.42.20.010 | 10mm | 10,2 | 1" | 268 | 108 | 6,35 | 23 | 20 | 12 | 1,63 | | Art.3.3 |
| REF24.42.20.038 | 3/8" | 9,7 | 1" | 268 | 108 | 6,35 | 23 | 20 | 12 | 1,63 | | Art.3.3 |
| REF24.42.20.012 | 12mm | 12,2 | 1" | 272 | 108 | 6,35 | 23 | 20 | 12 | 2,36 | | Art.3.3 |
| REF24.42.20.127 | 1/2" | 12,8 | 1" | 272 | 108 | 6,35 | 23 | 20 | 12 | 2,36 | | Art.3.3 |
| REF24.42.20.016 | 16mm 5/8" | 16,2 | 1" | 284 | 108 | 6,35 | 23 | 20 | 12 | 3,39 | | Art.3.3 |
| REF24.42.20.018 | 18mm | 18,2 | 1" | 284 | 112 | 6,35 | 23 | 20 | 12 | 3,11 | | Art.3.3 |
| REF24.43.22.012 | 12mm | 12,2 | 1-1/4" | 320 | 110 | 6,35 | 24 | 22 | 13 | 2,31 | | Art.3.3 |
| REF24.43.22.127 | 1/2" | 12,8 | 1-1/4" | 320 | 110 | 6,35 | 24 | 22 | 13 | 2,31 | | Art.3.3 |
| REF24.43.22.016 | 16mm 5/8" | 16,2 | 1-1/4" | 320 | 112 | 6,35 | 24 | 22 | 13 | 3,36 | | Art.3.3 |
| REF24.43.22.018 | 18mm | 18,2 | 1-1/4" | 335 | 112 | 6,35 | 24 | 22 | 13 | 3,84 | | Art.3.3 |
| REF24.43.22.034 | 3/4" | 19,3 | 1-1/4" | 335 | 112 | 6,35 | 24 | 22 | 13 | 3,46 | | Art.3.3 |
| REF24.43.30.018 | 18mm | 18,2 | 1-1/4" | 515 | 140 | 8,00 | 27 | 30 | 19 | 6,65 | | Art.3.3 |
| REF24.43.30.034 | 3/4" | 19,3 | 1-1/4" | 515 | 140 | 8,00 | 27 | 30 | 19 | 6,65 | | Art.3.3 |
| REF24.43.30.022 | 22mm 7/8" | 22,3 | 1-1/4" | 535 | 142 | 8,00 | 27 | 30 | 19 | 10,19 | | Art.3.3 |
| REF24.43.30.028 | 28mm | 28,2 | 1-1/4" | 535 | 150 | 8,00 | 27 | 30 | 19 | 10,53 | | Art.3.3 |
| REF24.43.30.118 | 1-1/8" | 28,8 | 1-1/4" | 535 | 150 | 8,00 | 27 | 30 | 19 | 10,53 | | Art.3.3 |
| REF24.44.30.018 | 18mm | 18,2 | 1-3/4" | 650 | 145 | 8,00 | 27 | 30 | 19 | 6,58 | -40/ +150 | Art.3.3 |
| REF24.44.30.034 | 3/4" | 19,3 | 1-3/4" | 650 | 145 | 8,00 | 27 | 30 | 19 | 6,58 | | Art.3.3 |
| REF24.44.30.022 | 22mm 7/8" | 22,3 | 1-3/4" | 600 | 145 | 8,00 | 27 | 30 | 19 | 10,12 | | Art.3.3 |
| REF24.44.30.028 | 28mm | 28,2 | 1-3/4" | 614 | 150 | 8,00 | 27 | 30 | 19 | 11,34 | | Art.3.3 |
| REF24.44.30.118 | 1-1/8" | 28,8 | 1-3/4" | 614 | 150 | 8,00 | 27 | 30 | 19 | 11,34 | | Art.3.3 |
| REF24.44.35.028 | 28mm | 28,2 | 1-3/4" | 614 | 165 | 9,60 | 31 | 35 | 24 | 11,74 | | Art.3.3 |
| REF24.44.35.118 | 1-1/8" | 28,8 | 1-3/4" | 792 | 165 | 9,60 | 31 | 35 | 24 | 11,74 | | Art.3.3 |
| REF24.44.35.035 | 35mm 1-3/8" | 35,2 | 1-3/4" | 792 | 170 | 9,60 | 31 | 35 | 24 | 15,58 | | Class I |
| REF24.44.35.042 | 42mm | 42,2 | 1-3/4" | 814 | 170 | 9,60 | 31 | 35 | 24 | 13,00 | | Class I |
| REF24.44.35.158 | 1-5/8" | 41,5 | 1-3/4" | 928 | 170 | 9,60 | 31 | 35 | 24 | 13,00 | | Class I |
| REF24.45.50.035 | 35mm 1-3/8" | 35,2 | 2-1/4" | 1620 | 200 | 9,60 | 36 | 50 | 39 | 25,45 | | Class I |
| REF24.45.50.042 | 42mm | 42,2 | 2-1/4" | 1650 | 200 | 9,60 | 36 | 50 | 39 | 33,08 | | Class I |
| REF24.45.50.158 | 1-5/8" | 41,5 | 2-1/4" | 1650 | 200 | 9,60 | 36 | 50 | 39 | 33,08 | | Class I |
| REF24.45.50.054 | 54mm 2-1/8" | 54,3 | 2-1/4" | 1690 | 200 | 9,60 | 36 | 50 | 39 | 31,24 | | Class I |

 Completely made of brass, REFRIGERA valves have the peculiar value to be provided with copper tube and INOX stem that assure easy torch-brazing with the normal filler metals for Cu to Cu joint and, on the other hand, corrosion resistance of all parts.

 Interamente realizzate in ottone, le valvole REFRIGERA hanno la peculiare caratteristica di essere provviste di tronchetti a saldare in rame e perno in acciaio INOX, permettendo, da un lato, il perfetto accoppiamento mediante brasatura a cannello con le consuete leghe rame fosforo e garantendo, dall'altro, l'inalterabilità nel tempo di tutte le parti.

 Die Ventile REFRIGERA sind ganz aus Messing hergestellt und haben als besonderes Merkmal Einschweißstutzen aus Kupfer und Zapfen aus EDELSTAHL, dies ermöglicht auf einer Seite eine perfekte Verbindung durch Hartlöten mit den herkömmlichen Kupfer-Phosphor-Legierungen und garantiert auf der anderen, die langfristige Haltbarkeit aller Teile.

 Entièrement réalisées en laiton, Les vannes Rotalock REFRIGERA ont la caractéristique d'être pourvues des connections à souder en cuivre avec le pivot en INOX. Grâce à cette particularité, sur une partie, la brasure avec les habituels alliages (pour la jonction Cu-Cu) est plus rapide et facile, et sur l'autre partie, le type de matériel préserve la vanne des éventuels problèmes de corrosion.

 Totalmente realizadas en bronce, las válvulas REFRIGERA tienen la particularidad de estar provistas de pequeños troncos soldados en cobre y con perno de acero INOX, permitiendo por un lado, el perfecto acoplamiento mediante soldadura con soplete con las habituales de cobre fósforo y garantizando, por otra parte, la inalterabilidad en el tiempo de todas las partes.

 Inteiramente produzidas em latão, as válvulas REFRIGERA apresentam uma característica peculiar pois dispõem, de soquetes soldados com cobre e pino de aço INOX, o que permite, de um lado, o perfeito acoplamento mediante brasagem com maçarico e as habituais ligas de cobre e fósforo e por outro lado, assegura a inalterabilidade de todos os componentes no decorrer do tempo.

 レフリジェラ・バルブは、完全にブラスで作られており、提供されるべき、優れた価値を保持します。コッパー・チューブとINOXステムが伴い、最小限のフィラー・メタルによるCuとCuジョイントの、簡潔なトーチ・ブレイジングを確実にし、またその一方で、すべてのパーツは耐侵食性を誇ります。

 Клапаны REFRIGERA, полностью реализованные из латуни, обладают особой характеристикой наличия привариваемых медных патрубков и стержня из нержавеющей стали, обеспечивая, с одной стороны, превосходное соединение посредством газопламенной пайки с обычными сплавами меди и фосфора, и гарантируя, с другой стороны, неизменяемость всех компонентов по истечению времени.

Brass Angle Valve

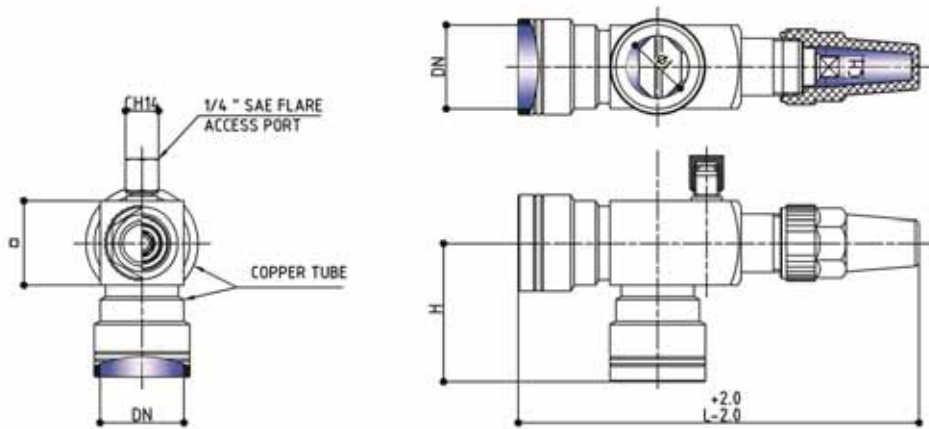
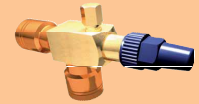

| Code | ODS | Connection | Weight | Length | Spanner | H | □ | Ø | Kv | WTemp | P.E.D. |
|---------------------|-------------|------------|--------|--------|---------|------|------|------|----------------|-----------|---------------|
| REF | DN | Ø | (g) | L (mm) | CH(mm) | (mm) | (mm) | (mm) | ΔP:1bar (m³/h) | °C | Group2 fluids |
| REF23.10.20.010.1.D | 10mm | 10,2 | 268 | 102 | 6,35 | 31 | 20 | 8 | - | | Art.3.3 |
| REF23.10.20.010.2.D | 3/8" | 9,7 | 268 | 102 | 6,35 | 31 | 20 | 8 | - | | Art.3.3 |
| REF23.10.20.012.1.D | 12mm | 12,2 | 272 | 105 | 6,35 | 31 | 20 | 10 | - | | Art.3.3 |
| REF23.10.20.012.2.D | 1/2" | 12,8 | 272 | 105 | 6,35 | 31 | 20 | 10 | - | | Art.3.3 |
| REF23.10.22.016.3.D | 16mm 5/8" | 16,2 | 284 | 107 | 6,35 | 36 | 22 | 13 | 6,39 | | Art.3.3 |
| REF23.10.30.018.1.D | 18mm | 18,2 | 284 | 141 | 8,00 | 47 | 30 | 20 | 8,97 | | Art.3.3 |
| REF23.10.30.018.2.D | 3/4" | 19,3 | 292 | 141 | 8,00 | 47 | 30 | 20 | 8,97 | | Art.3.3 |
| REF23.10.30.022.3.D | 22mm 7/8" | 22,3 | 292 | 141 | 8,00 | 47 | 30 | 20 | 12,60 | | Art.3.3 |
| REF23.10.30.028.1.D | 28mm | 28,2 | 314 | 145 | 8,00 | 51 | 30 | 20 | 10,99 | | Art.3.3 |
| REF23.10.30.028.2.D | 1-1/8" | 28,8 | 320 | 145 | 8,00 | 51 | 30 | 20 | 11,25 | -40/ +150 | Class I |
| REF23.10.35.035.3.D | 35mm | 35,2 | 320 | 172 | 9,60 | 57,5 | 35 | 26 | 13,44 | | Class I |
| REF23.10.35.042.1.D | 42mm | 42,2 | 320 | 172 | 9,60 | 57,5 | 35 | 26 | 13,43 | | Class I |
| REF23.10.35.042.2.D | 1-5/8" | 41,5 | 320 | 172 | 9,60 | 57,5 | 35 | 26 | 13,43 | | Class I |
| REF23.10.40.042.1.D | 42mm | 42,2 | 330 | 172 | 9,60 | 60 | 35 | 26 | 13,43 | | Class I |
| REF23.10.40.042.2.D | 1-5/8" | 41,5 | 330 | 172 | 9,60 | 60 | 35 | 26 | 13,43 | | Class I |
| REF23.10.50.042.1.D | 42mm | 42,2 | 335 | 200 | 9,60 | 73 | 50 | 38 | 36,74 | | Class I |
| REF23.10.50.042.2.D | 1-5/8" | 41,5 | 335 | 200 | 9,60 | 73 | 50 | 38 | - | | Class I |
| REF23.10.50.054.3.D | 54mm 2-1/8" | 54,3 | 515 | 200 | 9,60 | 73 | 50 | 38 | - | | Class I |
| REF23.10.65.054.3.D | 54mm 2-1/8" | 54,3 | 515 | 240 | 9,60 | 79,5 | 65 | 50 | - | | Class I |

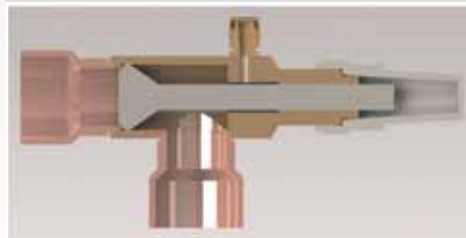

Fig.1 - Pos. A Front Seated

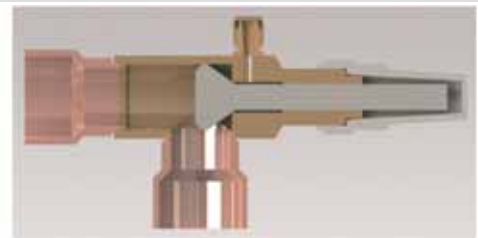





Fig.2 - Pos. B Back Seated

Tab.1- Coppie di serraggio consigliate (Nm). Suggested Tightening Torque (Nm).

| Corpo Body | Perno / Rod Front seated | Perno / Rod Back seated | Tappo Plastica / Plastic Cap | Tappo Pressa P1 / Gauge Port Cap |
|-------------------|--------------------------|-------------------------|------------------------------|----------------------------------|
| 23.10.20.010-.016 | 5-7 | 4-6 | 8 | 3-5 |
| 23.10.30.022-.028 | 7-10 | 6-9 | 8 | 3-5 |
| 23.10.35.035-.042 | 10-13 | 9-12 | 8 | 3-5 |
| 23.10.50.042-.054 | 20-25 | 18-22 | 16 | 3-5 |
| 23.10.65.054 | 25-30 | 22-27 | 16 | 3-5 |

 Completely made of carbon steel, REFRIGERA valves have the peculiar value to be provided with stainless steel stem that assure easy welding and corrosion resistance of all parts.

 Interamente realizzate in acciaio, le valvole REFRIGERA hanno la peculiare caratteristica di essere provviste di perno in acciaio, garantendo l'inalterabilità nel tempo di tutte le parti.

 Die Ventile REFRIGERA sind ganz aus Edelstahl hergestellt und haben als besonderes Merkmal Zapfen aus EDELSTAHL, dies garantiert die langfristige Haltbarkeit aller Teile.

 Entièrement réalisées en acier, Les vannes REFRIGERA ont la caractéristique d'être pourvues de pivot en acier inoxydable. Grâce à cette particularité le type de matériel préserve la vanne des éventuels problèmes de corrosion.

 Totalmente realizadas en acero, las válvulas REFRIGERA tienen la particularidad de estar provistas de perno de acero INOX garantizando la inalterabilidad en el tiempo de todas las partes.

 Inteiramente produzidas em aço, as válvulas REFRIGERA apresentam uma característica peculiar pois dispõem, de pino de aço INOX, o que assegura a inalterabilidade de todos os componentes no decorrer do tempo.

 レフリジェラ・バルブは、に球状鋳鉄製提供されるべき、優れた価値を保持します。・とINOXシステムが伴い、最小限のフィルター・メタルによるジョイントの、簡潔なトーチ・ブレンジングを確実にし、またその一方で、すべてのパーツは耐侵食性を誇ります。

 Клапаны REFRIGERA полностью реализованы из чугуна с стали. палец из нержавеющей стали гарантируют хорошую сварку и сопротивление коррозии.

Nickel Coated Angle Valve

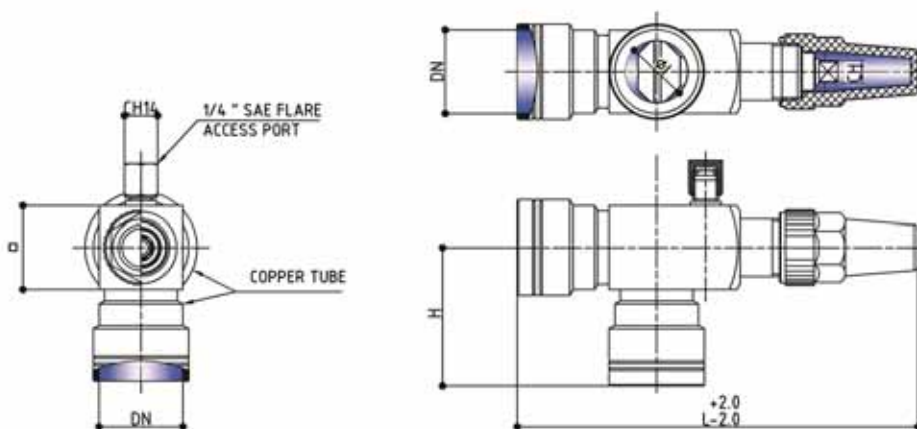



| Code | ODS | Connection | Weight | Length | Spanner | H | □ | ØI | Kv | WTemp | P.E.D. |
|-------------------|-------------|------------|--------|--------|---------|------|------|------|----------------|-----------|---------------|
| REF | DN | Ø | (g) | L (mm) | CH(mm) | (mm) | (mm) | (mm) | ΔP:1bar (m³/h) | °C | Group2 fluids |
| REF25.10.20.010.D | 10mm | 10,2 | 268 | 102 | 6,35 | 31 | 20 | 8 | - | - | Art.3.3 |
| REF25.10.20.038.D | 3/8" | 9,7 | 268 | 102 | 6,35 | 31 | 20 | 8 | - | - | Art.3.3 |
| REF25.10.20.012.D | 12mm | 12,2 | 272 | 105 | 6,35 | 31 | 20 | 10 | - | - | Art.3.3 |
| REF25.10.20.127.D | 1/2" | 12,8 | 272 | 105 | 6,35 | 31 | 20 | 10 | - | - | Art.3.3 |
| REF25.10.22.016.D | 16mm 5/8" | 16,2 | 284 | 107 | 6,35 | 36 | 22 | 13 | 6,39 | - | Art.3.3 |
| REF25.10.30.018.D | 18mm | 18,2 | 284 | 141 | 8,00 | 47 | 30 | 20 | 8,97 | - | Art.3.3 |
| REF25.10.30.034.D | 3/4" | 19,3 | 292 | 141 | 8,00 | 47 | 30 | 20 | 8,97 | - | Art.3.3 |
| REF25.10.30.022.D | 22mm 7/8" | 22,3 | 292 | 141 | 8,00 | 47 | 30 | 20 | 12,60 | - | Art.3.3 |
| REF25.10.30.028.D | 28mm | 28,2 | 314 | 145 | 8,00 | 51 | 30 | 20 | 10,99 | -40/ +150 | Art.3.3 |
| REF25.10.30.118.D | 1-1/8" | 28,8 | 320 | 145 | 8,00 | 51 | 30 | 20 | 11,25 | - | Class I |
| REF25.10.36.035.D | 35mm | 35,2 | 320 | 172 | 9,60 | 57,5 | 35 | 26 | 13,44 | - | Class I |
| REF25.10.36.042.D | 42mm | 42,2 | 320 | 172 | 9,60 | 57,5 | 35 | 26 | 13,43 | - | Class I |
| REF25.10.36.158.D | 1-5/8" | 41,5 | 320 | 172 | 9,60 | 57,5 | 35 | 26 | 13,43 | - | Class I |
| REF25.10.50.054.D | 54mm 2-1/8" | 54,3 | 515 | 200 | 9,60 | 73 | 50 | 38 | - | - | Class I |

 Completely made of steel, REFRIGERA driers have the peculiar value to be provided with a spherical shaped molecular sieve, so moisture and acids are absorbed as much as its volume homogeneously. However, in cartridge shape filters, particles are held on the surface and so it becomes useless in short period. We guarantee higher acid and water absorption than silica-gel and activated alumina and absorption of dirt particles more than size of 10 microns by the filtration grade, keeping however a minimum flow resistance.

 I filtri in acciaio REFRIGERA possiedono la peculiarità della costruzione a sfere dei setacci molecolari, ciò mette a contatto il fluido refrigerante con la massima superficie filtrante possibile per garantire un assorbimento omogeneo delle sostanze acide e una maggior durata rispetto ai filtri a cartuccia solida. Rispetto al gel di silice e all'alumina attiva, inoltre, i setacci molecolari posseggono una maggiore capacità di assorbimento dell'acqua pur garantendo minori perdite di carico. Viene garantito il filtraggio completo di particelle sino a 10 micron.

 Die Stahlfilter REFRIGERA haben das besondere Merkmal der Bauweise der Molekularsiebe in Kugelform, die Kältemittelflüssigkeit kommt mit der maximal möglichen Filterfläche in Berührung, um die homogene Absorbierung der Säurelösungen und eine längere Haltbarkeit als die der Patronenfilter zu gewährleisten. Im Vergleich zu Siliziumoxidgel und aktivem Aluminiumoxid besitzen die Molekularsiebe eine größere wasserabsorbierende Kapazität, wobei minimale Druckverluste gewährleistet sind. Die Filterung von Partikeln bis zu 10 Mikron wird garantiert.

 Entièrement en acier, les filtres RÉFRIGÉRA ont l'avantage d'être munis d'un tamis moléculaire en forme sphérique, afin qu'un maximum de fluide frigorigène soit en contact avec la plus grande surface de filtration possible et assurer une absorption uniforme des résidus d'acide et la plus longue durée de la cartouche du filtre. Par rapport à un gel de silice et d'alumine active, les tamis moléculaires possèdent, en outre, une plus grande capacité à absorber l'eau tout en maintenant une faible perte de charge. Ils garantissent un filtrage de particules jusque 10 microns.

 Los filtros de acero REFRIGERA poseen la particularidad de estar contruidos como los cedazos moleculares a esfera, es decir ponen en contacto el fluido refrigerante con la máxima superficie filtrante posible para garantizar una absorción homogénea de ácidos y una mayor duración con respecto a los filtros de cartuchos sólidos. En lo que respecta al gel de silicio y el aluminio activo, además, los cedazos moleculares poseen una mayor capacidad de absorción de agua garantizando la filtración completa de las particiones hasta 10 micrones.

 Os filtros de aço REFRIGERA apresentam uma característica peculiar na produção de peneiras moleculares com esferas logo, permite colocar o fluido refrigerante em contato com a máxima superfície filtrante possível para garantir a absorção homogênea das salmouras ácidas e maior duração em relação aos filtros de cartucho sólidos. Com relação ao gel de sílica e alumina ativa, as peneiras moleculares possuem uma capacidade maior de absorção da água mesmo garantindo uma queda de pressão menor. Garantem a filtração completa de partículas até 10 microns.

 レフリジェラ・ドライヤーは、完全にスチールによって作られており、提供されるべき、優れた価値を保持しています。これらは、スフィア形状のモレキュラー・シーヴを伴うため、湿度と酸が、そのポリリウムまで、同量に吸収されます。しかしながら、カートリッジ・シェイプのフィルターの中で、パーティクルが表面上に帯びるため、よってこれは短い期間で、使用できなくなります。最小のフロー・レジスタンスを維持しつつ、弊社は、シリカ・ゲルと活性アルミナよりも高い、酸および水の吸収、および、フィルタレーション・グレードで10マイクロンのサイズ以上の、汚れパーティクルの濾過を保証します。

 Стальные фильтры REFRIGERA обладают особенностью шаровой конструкции молекулярных сит. Это обеспечивает контакт охлаждающей жидкости с максимальной возможной фильтрующей поверхностью, чтобы гарантировать однократное поглощение кислых расщепов и более длительный срок службы по сравнению с фильтрами с твердым патроном. По сравнению с силикагелем и активным оксидом алюминия, молекулярные сита обладают наибольшей возможностью поглощения воды, гарантируя при этом меньшие потери давления. Гарантируется полная ультрация частиц до 10 микрон.

Filter Drier

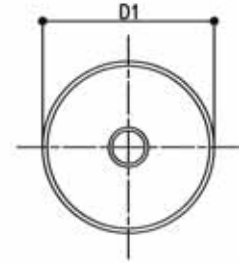
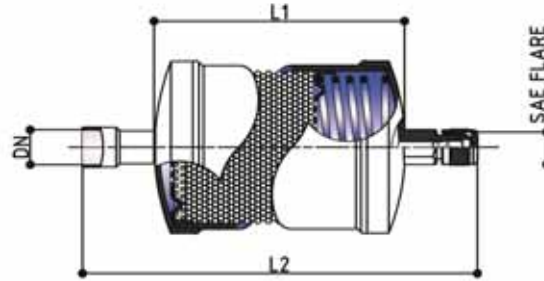



| Code | ODS Con. | SAE Con. | Length | Refrigeration Capacity (kW) DP 0,06 Bar | | | | | | | | Weight of dehydratable Refrigerant in kg +25°C | | | | Body Length | Diam | WTemp | Volume |
|------------------|----------|----------|---------|---|------------|-----------|-------|------|-------|-------|------|--|---------|-----------|-------|-------------|------|-------|--------|
| | | | | R134A | R404A R507 | R22 R407C | R134A | R22 | R404A | R407C | R507 | L1 (mm) | D1 (mm) | °C | (cm³) | | | | |
| REF | DN | SAE | L2 (mm) | R134A | R404A R507 | R22 R407C | R134A | R22 | R404A | R407C | R507 | L1 (mm) | D1 (mm) | °C | (cm³) | | | | |
| REF70.052.01.006 | 6mm | - | 102 | 6 | 4 | 7,5 | 5,4 | 5,3 | 5,8 | 3,5 | 5,2 | 62 | 48 | | 83 | | | | |
| REF70.052.01.014 | 1/4" | - | 102 | 6 | 4 | 7,5 | 5,4 | 5,3 | 5,8 | 3,5 | 5,2 | 62 | 48 | | 83 | | | | |
| REF70.053.01.010 | 10mm | - | 112 | 15 | 10 | 16 | 5,4 | 5,3 | 5,8 | 3,5 | 5,2 | 62 | 48 | | 83 | | | | |
| REF70.053.01.038 | 3/8" | - | 112 | 15 | 10 | 16 | 5,4 | 5,3 | 5,8 | 3,5 | 5,2 | 62 | 48 | | 83 | | | | |
| REF70.083.01.010 | 10mm | - | 136 | 21 | 15 | 23 | 12,2 | 12,1 | 13,2 | 8 | 11,7 | 86 | 63 | | 210 | | | | |
| REF70.083.01.038 | 3/8" | - | 136 | 21 | 15 | 23 | 12,2 | 12,1 | 13,2 | 8 | 11,7 | 86 | 63 | | 210 | | | | |
| REF70.084.01.012 | 12mm | - | 143 | 29 | 22 | 32 | 14,6 | 14,5 | 15,9 | 9,6 | 14,1 | 93 | 63 | | 230 | | | | |
| REF70.084.01.127 | 1/2" | - | 143 | 29 | 22 | 32 | 14,6 | 14,5 | 15,9 | 9,6 | 14,1 | 93 | 63 | | 230 | | | | |
| REF70.164.01.012 | 12mm | - | 156 | 34 | 25 | 37 | 21,2 | 20,9 | 23 | 13,8 | 20,3 | 106 | 63 | | 265 | | | | |
| REF70.164.01.127 | 1/2" | - | 156 | 34 | 25 | 37 | 21,2 | 20,9 | 23 | 13,8 | 20,3 | 106 | 63 | | 265 | | | | |
| REF70.165.01.016 | 16mm | - | 164 | 47 | 33 | 52 | 34,1 | 33,7 | 37,1 | 22,2 | 32,6 | 106 | 79 | -40/ +120 | 430 | | | | |
| REF70.304.01.012 | 12mm | - | 232 | 37 | 27 | 41 | 60 | 59,2 | 65,1 | 39 | 57,3 | 182 | 79 | | 750 | | | | |
| REF70.304.01.127 | 1/2" | - | 232 | 37 | 27 | 41 | 60 | 59,2 | 65,1 | 39 | 57,3 | 182 | 79 | | 750 | | | | |
| REF70.305.01.016 | 16mm | - | 240 | 53 | 39 | 59 | 60 | 59,2 | 65,1 | 39 | 57,3 | 182 | 79 | | 750 | | | | |
| REF70.052.02.014 | - | 1/4" | 110 | 6 | 4 | 7,5 | 5,4 | 5,3 | 5,8 | 3,5 | 5,2 | 62 | 48 | | 83 | | | | |
| REF70.082.02.014 | - | 1/4" | 140 | 8,5 | 6 | 10 | 9,4 | 9,3 | 10,2 | 6,1 | 8,9 | 92 | 48 | | 125 | | | | |
| REF70.163.02.038 | - | 3/8" | 161 | 25 | 18 | 27 | 21,2 | 20,9 | 23 | 13,8 | 20,3 | 106 | 63 | | 265 | | | | |
| REF70.164.02.127 | - | 1/2" | 167 | 34 | 25 | 37 | 21,2 | 20,9 | 23 | 13,8 | 20,3 | 106 | 63 | | 265 | | | | |
| REF70.165.02.016 | - | 5/8" | 175 | 47 | 33 | 52 | 34,1 | 33,7 | 37,1 | 22,2 | 32,6 | 106 | 79 | | 430 | | | | |
| REF70.305.02.016 | - | 5/8" | 251 | 53 | 39 | 59 | 60 | 59,2 | 65,1 | 39 | 57,3 | 182 | 79 | | 750 | | | | |

| TYPE | VOLUME 3 cm | CONNECTION SOLDER TYPE | Inch | Metric | WATER ADSORPTION CAPACITY 25 - C (g) | | | | | | | | WATER ADSORPTION CAPACITY 50 - C (g) | | | |
|-----------------|-------------|------------------------|-------|--------|--------------------------------------|------|-------|-------|------|-------|------|-------|--------------------------------------|------|--|--|
| | | | | | R134a | R22 | R404A | R407C | R507 | R134a | R22 | R404A | R407C | R507 | | |
| ESSDS 0525 1/4" | 83 | 1/4" | 6 mm | 4,3 | 4,2 | 4,6 | 2,8 | 4,1 | 3,6 | 3,4 | 4,0 | 2,8 | 3,2 | | | |
| ESSDS 0825 1/4" | 125 | 1/4" | 6 mm | 7,5 | 7,4 | 8,1 | 4,9 | 7,1 | 6,3 | 6,0 | 7,0 | 4,9 | 5,6 | | | |
| ESSDS 0825 6 mm | 83 | 3/8" | 10 mm | 4,3 | 4,2 | 4,6 | 2,8 | 4,1 | 3,6 | 3,4 | 4,0 | 2,8 | 3,2 | | | |
| ESSDS 0535 3/8" | 210 | 3/8" | 10 mm | 10,6 | 10,5 | 11,5 | 6,9 | 10,1 | 9,0 | 8,6 | 10,0 | 7,0 | 8,0 | | | |
| ESSDS 0835 3/8" | 265 | 3/8" | 10 mm | 18,0 | 17,8 | 19,6 | 11,8 | 17,3 | 15,3 | 14,6 | 17,0 | 11,9 | 13,6 | | | |
| ESSDS 1635 3/8" | 230 | 1/2" | 12 mm | 12,7 | 12,6 | 13,8 | 8,3 | 12,2 | 10,8 | 10,3 | 12,0 | 8,4 | 9,6 | | | |
| ESSDS 0845 1/2" | 265 | 1/2" | 12 mm | 18,0 | 17,8 | 19,6 | 11,8 | 17,3 | 15,3 | 14,6 | 17,0 | 11,9 | 13,6 | | | |
| ESSDS 1645 1/2" | 750 | 1/2" | 12 mm | 47,7 | 47,1 | 51,8 | 31,1 | 45,6 | 40,5 | 38,7 | 45,0 | 31,5 | 36,0 | | | |
| ESSDS 3045 1/2" | 430 | 5/8" | 29,6 | 29,3 | 32,2 | 19,3 | 28,3 | 25,2 | 24,1 | 28,0 | 19,6 | 22,4 | | | | |
| ESSDS 1655 5/8" | 750 | 5/8" | 47,7 | 47,1 | 51,8 | 31,1 | 45,6 | 40,5 | 38,7 | 45,0 | 31,5 | 36,0 | | | | |
| ESSDS 3055 5/8" | 690 | 5/8" | 58,2 | 57,6 | 63,3 | 38,0 | 55,7 | 49,5 | 47,3 | 55,0 | 38,5 | 44,0 | | | | |





 Completely made of steel, REFRIGERA driers have been provided with a molecular sieve functional for dirt particles more than size of 10 microns by the filtration grade, keeping however a minimum flow resistance. The SOLID CORE filters are BI-FLOW for reverse flow application: internal check valves provide precise bi-directional control. Molecular sieve cartridges are 20% added of activated alumina to guarantee high acid absorption.

 Completamente in acciaio, i filtri REFRIGERA possiedono un setaccio molecolare con grado di filtrazione adatto a particelle di dimensioni oltre i 10 micron, mantenendo tuttavia una minima resistenza al flusso. I filtri SOLID CORE sono BI-FLOW per l'utilizzo nei sistemi split. Il setaccio molecolare a cartucce è additivato di allumina attivata al 20% per garantire un più elevato assorbimento degli acidi.

 Die Filter REFRIGERA sind ganz aus Stahl und verfügen über ein Molekularsieb mit einem Filtergrad, der sich für Partikel, die größer als 10 Mikron sind, ein minimaler Durchflusswiderstand bleibt dabei erhalten. Die SOLID CORE-Filter sind BI-FLOW für den Einsatz in Splitsystemen. Das Molekularsieb mit Trockenpatronen hat als Zusatz 20% aktiviertes Aluminiumoxid, um eine höhere Absorbierung der Säuren zu gewährleisten.

 Entièrement en acier, les filtres REFRIGERA sont fournis avec un tamis moléculaire fonctionnel pour particules impures, de taille supérieure à 10 microns, selon le degré de filtrage, en préservant toutefois un minimum de résistance à l'écoulement. Les filtres SOLID CORE sont BI-DIRECTIONNELS pour l'utilisation dans les systèmes split. Les tamis moléculaire et cartouches sont additionnés de 20% d'alumine active afin de garantir l'absorption des acides.

 Construidos totalmente en acero, los filtros REFRIGERA poseen un cedazo molecular con grados de filtraciones adaptados a particulas de dimensiones superiores a los 10 micrones, manteniendo así una mínima resistencia al flujo. Los filtros SOLID CORE son BI-FLOW cuando se utilizan en los sistemas split. El cedazo molecular a cartucho tiene además aluminio activo al 20% para garantizar un absorbimiento de los ácidos más elevado.

 Completamente produzidos em aço, os filtros REFRIGERA possuem uma peneira molecular com grau de filtração apropriado para partículas de dimensões além de 10 microns, mantendo no entanto um fluxo com resistência mínima. Os filtros SOLID CORE são BI-FLOW para serem utilizados nos sistemas split. A peneira molecular de cartucho é aditivada com alumina ativada a 20% para garantir uma absorção mais elevada dos ácidos.

 レフリジャー・ドライヤーは完全にスチールによって作られており、モレキュラー・シーヴを付属してきました。これは、フィルタレーション・グレードで10マイクロンのサイズ以上の汚れパーティクルに効果を持ち、最小のフロー・レジスタンスを維持します。ソリッド・コア・フィルターはバイ・フローであり、リバース・フロー・アプリケーション向けです。内部のチェック・バルブが、精細なバイ・ディレクショナルなコントロールを提供します。モレキュラー・シーヴ・カートリッジは、活性アルミナを20%加えられており、高い酸・吸収を保証します。

 Фильтры REFRIGERA, полностью выполненные из стали, обладают молекулярным ситом со степенью фильтрации, соответствующей частицам размером до 10 микрон, тем не менее, сохраняя минимальное сопротивление потоку. Фильтры SOLID CORE являются BI-FLOW для использования в системах split. Молекулярное сито с патронами дополняется 20% активным оксидом алюминия для гарантии более высокого поглощения кислот.

Bi-Flow Filter Drier

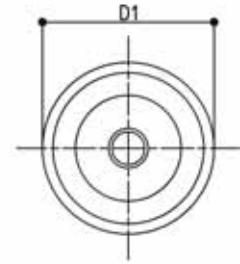
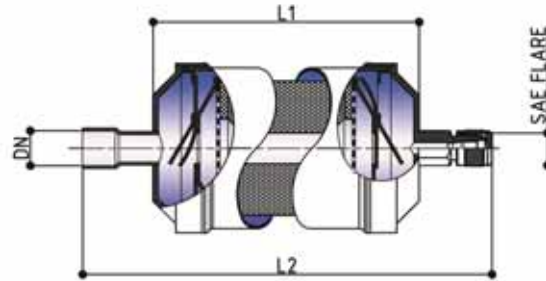

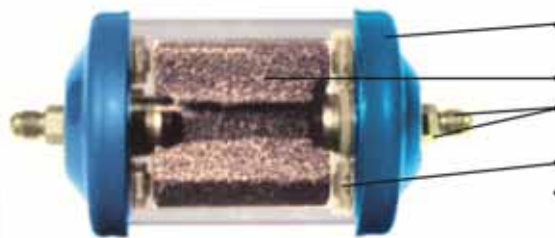

| Code | ODS Con. | SAE Con. | Length | Liquid Refrigerant Capacity +38°C | Drying Capacity in H2O Drops | Body Length | Diam | WTemp | Volume |
|------------------|----------|----------|---------|-----------------------------------|------------------------------|-------------|---------|----------|--------------------|
| REF | DN | SAE | L2 (mm) | | 24°C 52°C | L1 (mm) | D1 (mm) | °C | (cm ³) |
| REF71.083.01.038 | 3/8" | - | 140 | 238 | 136,5 75 | 86 | 63 | | 210 |
| REF71.084.01.127 | 1/2" | - | 144 | 278 | 136,5 130 | 93 | 63 | | 230 |
| REF71.164.01.127 | 1/2" | - | 152 | 278 | 159 130 | 106 | 63 | -40/+120 | 265 |
| REF71.165.01.016 | 5/8" | - | 158 | 278 | 159 130 | 106 | 63 | | 430 |





- Three layers of paint for maximum corrosion resistance
- Solid core of activated Alumina with molecular sieve
- Nickel plated fittings and end caps (solid copper fittings on solder type)
- Large check valves for maximum flow
- Heavy gauge steel shell





 Completely made of steel, REFRIGERA driers have been provided with a molecular sieve functional for dirt particles more than size of 10 microns by the filtration grade, keeping however a minimum flow resistance. Molecular sieve cartridges are 20% added of activated alumina to guarantee high acid absorption.

 Completamente in acciaio, i filtri REFRIGERA possiedono un setaccio molecolare con grado di filtrazione adatto a particelle di dimensioni oltre i 10 micron, mantenendo tuttavia una minima resistenza al flusso. Il setaccio molecolare a cartucce è attivato di allumina attivata al 20% per garantire un più elevato assorbimento degli acidi.

 Die ganz aus Stahl hergestellten Filter REFRIGERA verfügen über ein Molekularsieb mit einem Filtergrad, der sich für Partikel bis zu einer Größe von 10 Mikron eignet, ein minimaler Durchflusswiderstand bleibt dabei erhalten. Das Molekularsieb mit Trockenpatronen hat als Zusatz 20% aktiviertes Aluminiumoxid, um eine höhere Absorbierung der Säuren zu gewährleisten.

 Entièrement en acier, les filtres REFRIGERA sont fournis avec un tamis moléculaire fonctionnel pour particules impures, de taille supérieure à 10 microns, selon le degré de filtration, en préservant toutefois un minimum de résistance à l'écoulement. Les tamis moléculaire et cartouches sont additionnés de 20% d'alumine active afin de garantir l'absorption des acides.

 Completamente en acero, los filtros REFRIGERA poseen un cedazo molecular con grado de filtración adaptados a particulas de dimensiones hasta 10 micrones, mateniendo así una mínima resistencia al flujo. El cedazo molecular a cartucho posee también un aditivo de aluminio activo al 20% para garantizar un absorbimiento de los ácidos más elevado.

 Completamente produzidos em aço, os filtros REFRIGERA possuem uma peneira molecular com grau de filtração apropriado para partículas de dimensões até 10 microns, mantendo no entanto um fluxo com resistência mínima. A peneira molecular de cartucho é ativada com alumina ativada a 20% para garantir uma absorção mais elevada dos ácidos.

 レフリジヤ・ドライヤーは完全にスチールによって作られており、モレキュラー・シーヴを付属してきました。これは、フィルタレーション・グレードで10マイクロンのサイズ以上の汚れパーティクルに効果を持ち、最小のフロー・レジスタンスを維持します。モレキュラー・シーヴ・カートリッジは、活性アルミナを20% 加えられており、高い酸・吸収を保証します。

 Фильтры REFRIGERA, полностью выполненные из стали, обладают молекулярным ситом со степенью фильтрации, соответствующей частицам размером до 10 микрон, тем не менее, сохраняя минимальное сопротивление потоку. Молекулярное сито с патронами дополняется 20% активным оксидом алюминия для гарантии более высокого поглощения кислот.

Solid Core Filter Drier

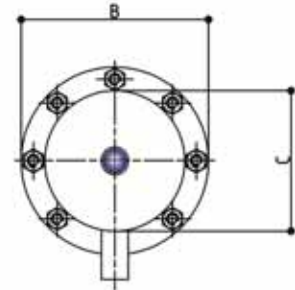
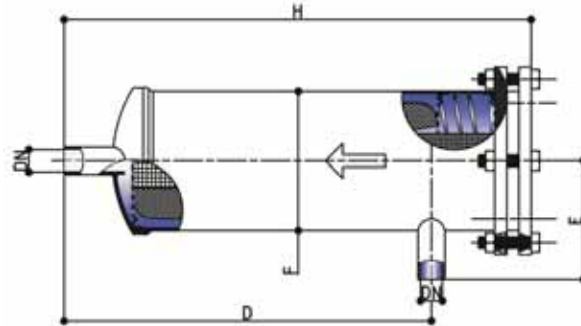
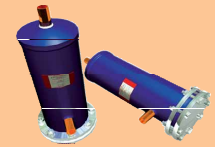



| Code | ODS | Length | Refrigeration Capacity kW | | | | | Conn position | Conn length | Filter Diam | Flange Diam | EX Diam | # | WT | P.E.D. |
|------------------|--------|--------|---------------------------|-------|-------------|-------|-------|---------------|-------------|-------------|-------------|---------|---|----------|---------------|
| REF | DN | H (mm) | R134A R507 | R12 | R407C R410A | R404A | R502 | D (mm) | E (mm) | F (mm) | B (mm) | C (mm) | n | °C | Group2 Fluids |
| REF72.048.01.058 | 5/8" | 237 | 28,2 | 28,2 | 35,2 | 28,2 | 28,2 | 155 | 80 | 114 | 154 | 120 | 1 | | Class I |
| REF72.048.01.078 | 7/8" | 241 | 35,2 | 35,2 | 45,8 | 35,2 | 35,2 | 159 | 82 | 114 | 154 | 120 | 1 | | Class I |
| REF72.048.01.118 | 1-1/8" | 238 | 35,2 | 35,2 | 45,8 | 35,2 | 35,2 | 160 | 82 | 114 | 154 | 120 | 1 | | Class I |
| REF72.048.01.138 | 1-3/8" | 248 | 45,8 | 45,8 | 70,4 | 45,8 | 45,8 | 163 | 86 | 114 | 154 | 120 | 1 | | Class I |
| REF72.048.01.158 | 1-5/8" | 248 | 45,8 | 45,8 | 70,4 | 45,8 | 45,8 | 163 | 86 | 114 | 154 | 120 | 1 | | Class I |
| REF72.048.01.218 | 2-1/8" | 248 | 45,8 | 45,8 | 70,4 | 45,8 | 45,8 | 163 | 86 | 114 | 154 | 120 | 1 | | Class I |
| REF72.048.01.258 | 2-5/8" | 248 | 45,8 | 45,8 | 70,4 | 45,8 | 45,8 | 163 | 86 | 114 | 154 | 120 | 1 | | Class I |
| REF72.096.01.078 | 7/8" | 385 | 70,4 | 70,4 | 88,0 | 52,8 | 52,8 | 302 | 83 | 114 | 154 | 120 | 2 | | Class II |
| REF72.096.01.118 | 1-1/8" | 385 | 88,0 | 88,0 | 105,6 | 70,4 | 70,4 | 304 | 83 | 114 | 154 | 120 | 2 | -40/+120 | Class II |
| REF72.096.01.138 | 1-3/8" | 389 | 105,6 | 105,6 | 123,2 | 88,0 | 88,0 | 306 | 86 | 114 | 154 | 120 | 2 | | Class III |
| REF72.096.01.158 | 1-5/8" | 389 | 123,2 | 123,2 | 140,8 | 105,6 | 105,6 | 306 | 86 | 114 | 154 | 120 | 2 | | Class III |
| REF72.096.01.218 | 2-1/8" | 389 | 123,2 | 123,2 | 140,8 | 105,6 | 105,6 | 438 | 86 | 114 | 154 | 120 | 2 | | Class III |
| REF72.096.01.258 | 2-5/8" | 389 | 123,2 | 123,2 | 140,8 | 105,6 | 105,6 | 438 | 83 | 114 | 154 | 120 | 2 | | Class III |
| REF72.144.01.118 | 1-1/8" | 520 | 105,6 | 105,6 | 140,8 | 105,6 | 105,6 | 438 | 83 | 114 | 154 | 120 | 3 | | Class III |
| REF72.144.01.138 | 1-3/8" | 527 | 140,8 | 140,8 | 176,0 | 123,2 | 123,2 | 445 | 83 | 114 | 154 | 120 | 3 | | Class III |
| REF72.144.01.158 | 1-5/8" | 527 | 158,4 | 158,4 | 193,6 | 140,8 | 140,8 | 445 | 86 | 114 | 154 | 120 | 3 | | Class III |
| REF72.144.01.218 | 2-1/8" | 532 | 176,0 | 176,0 | 211,2 | 158,4 | 158,4 | 448 | 89 | 114 | 154 | 120 | 3 | | Class III |

 Molecular sieve functional for dirt particles more than size of 10 microns by the filtration grade, keeping however a minimum flow resistance. Molecular sieve cartridges are 20% added of activated alumina to guarantee high acid absorption.

 Setaccio molecolare con grado di filtrazione adatto a particelle di dimensioni oltre i 10 micron, mantenendo tuttavia una minima resistenza al flusso. Il setaccio molecolare a cartucce è additivato di allumina attivata al 20% per garantire un più elevato assorbimento degli acidi.

 Molekularsieb mit einem Filtergrad, der sich für Partikel bis zu 10 Mikron eignet, ein minimaler Durchflusswiderstand bleibt dabei erhalten. Das Molekularsieb mit Trockenpatronen hat als Zusatz 20% aktiviertes Aluminiumoxid, um eine höhere Absorbierung der Säuren zu gewährleisten.

 Les tamis moléculaires pour particules impures sont de taille supérieure à 10 microns selon le degré de filtration, préservant toutefois un minimum de résistance à l'écoulement. Les tamis moléculaire et cartouches sont additionnés de 20% d'alumine active afin de garantir l'absorption des acides.

 Cedazos moleculares con grados de filtraciones adaptados a particiones de dimensiones hasta 10 micrones, manteniendo así una mínima resistencia al flujo. El cedazo molecular a cartucho posee un aditivo de aluminio activado al 20% para garantizar un absorbimiento de los ácidos más elevado.

 Peneira molecular com grau de filtração apropriado para partículas de dimensões até 10 microns, mantendo no entanto um fluxo com resistência mínima. A peneira molecular de cartucho é aditivada com alumina ativada a 20% para garantir uma absorção mais elevada dos ácidos.

 モレキュラー・シーヴは、フィルタレーション・グレードで10マイクロンのサイズ以上の汚れパーティクルに効果を持ち、最小のフロー・レジスタンスを維持します。モレキュラー・シーヴ・カートリッジは、活性アルミナを20%加えられており、高い酸・吸収を保証します。

 Молекулярное сито со степенью фильтрации, соответствующей частицам размером до 10 микрон, тем не менее, сохраняя минимальное сопротивление потоку. Молекулярное сито с патронами дополняется 20% активным оксидом алюминия для гарантии более высокого поглощения кислот.

Solid Core

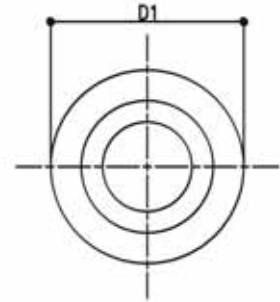
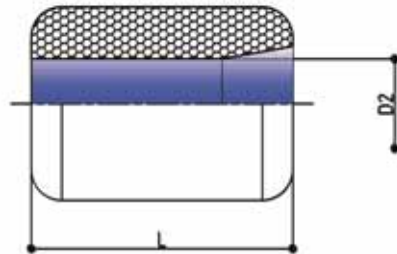



| Code | De | Di | Overall Length | Description | Use |
|------------------|---------|---------|----------------|--------------------------------------|--|
| REF | D1 (mm) | D2 (mm) | L (mm) | | |
| REF72.048.08.001 | 94 | 44 | 140 | 100% Molecular Sieve | MOISTURE REMOVAL |
| REF72.048.08.002 | 94 | 44 | 140 | 80% M.S. + 20% Act.Alumina | ACID AND MOISTURE REMOVAL |
| REF72.048.08.003 | 94 | 44 | 140 | 46% M.S + 47%Act.Alumina + 5% Carbon | HIGH CAPACITY FOR ACID REMOVAL CLEAN UP FOR MOTOR BURNS |
| REF72.048.08.004 | 94 | 44 | 140 | Mechanical Filter | SUCTION FILTER |





THE IMAGE SHOWS: a Solid Core replaceable Cartridge in its packing can

 Refrigerators, manufactured with the glass lens fused into the metallic ring, consist of a sensitive element as a ring, which changes color according to the percentage of moisture in the system. In detail:

 Gli indicatori Refrigerera, realizzati con una spia in vetro fusa direttamente nella ghiera metallica, sono costituiti da un elemento sensibile a forma di anello il cui colore indica il valore di umidità sulla linea pari a:

 Die Anzeigen Refrigerera sind mit einem direkt in den Metallring eingelassenen Kontrollfenster hergestellt und bestehen aus einem sensiblen, ringförmigen Element, dessen Farbe den Feuchtigkeitswert auf der Leitung wie nachstehend anzeigt: (siehe Tabelle):

 Les voyants Refrigerera sont réalisés avec un témoin en verre fondu directement dans le collier métallique. Ils sont constitués d'un élément sensible en forme d'anneau dont la couleur permet une vérification rapide de la présence d'humidité sur la ligne, (voir le tableau):

 Los indicadores REFRIGERA realizados con una mirilla de vidrio fundida directamente a la abrazadera metálica, están constituidos por un elemento sensible en forma de anillo cuyos colores indican el valor de humedad en el sistema (ver la tabla).

 Os indicadores Refrigerera, fabricados com uma lente de vidro fundida diretamente no anel metálico, são constituídos por um elemento sensível em forma de anel cuja cor indica o valor da umidade na linha, que é igual a: (veja tabela).

 レフリジェラ・インディケーターは、ガラス・レンズをメタリック・リングの中にフェーズして製造されており、システム中の湿度のパーセンテージによって色が変わる、リング状のセンシティブ・エレメントにより構成されています。詳細：(下記の表を参照)

 Индикаторы Refrigerera, реализованные со стеклянным отверстием, впаиваемым непосредственно в металлическое жесткое кольцо, состоят из чувствительного элемента в форме кольца, цвет которого указывает на значение влажности на линии, равное.

Moisture/Liquid Indicator

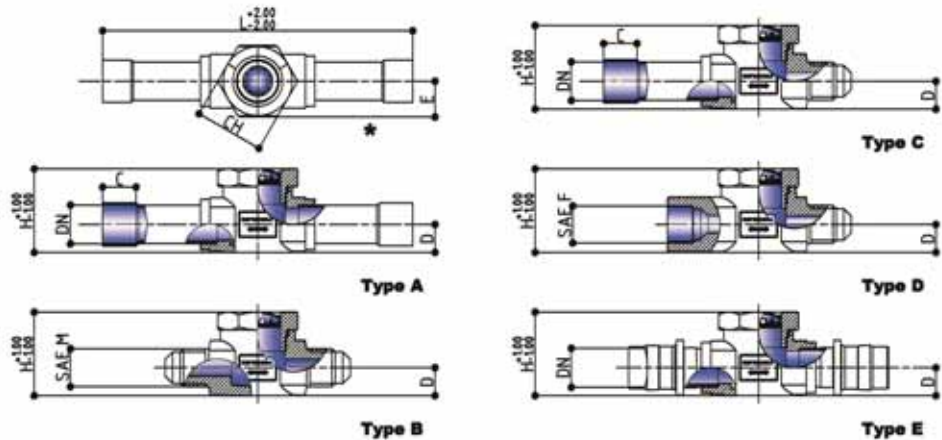



| Code | Image ref. | Dimensions | Dimensions | C | D | E | Length | Height | Kv | WTemp | P.E.D. |
|-----------------|------------|------------|------------|------|------|------|---------|--------|---|-----------|---------------|
| REF | * | ODS DN | SAE DN | (mm) | (mm) | (mm) | L (mm) | H (mm) | $\Delta P: 1\text{bar}$ (m ³ /h) | °C | Group2 fluids |
| REF60.00.01.006 | TYPE A | 6mm | - | 7 | 10 | 15 | 125/103 | 30 | 0.8 | | Art.3.3 |
| REF60.00.01.014 | TYPE A | 1/4" | - | 7 | 10 | 15 | 125 | 30 | 0.8 | | Art.3.3 |
| REF60.00.01.010 | TYPE A | 10mm | - | 9 | 10 | 15 | 125/107 | 30 | 3.5 | | Art.3.3 |
| REF60.00.01.038 | TYPE A | 3/8" | - | 9 | 10 | 15 | 125 | 30 | 3.5 | | Art.3.3 |
| REF60.00.01.012 | TYPE A | 12mm | - | 12 | 10 | 15 | 125/109 | 30 | 5 | | Art.3.3 |
| REF60.00.01.127 | TYPE A | 1/2" | - | 12 | 10 | 15 | 125 | 30 | 5 | | Art.3.3 |
| REF60.00.01.016 | TYPE A | 16mm 5/8" | - | 14 | 12 | 15 | 125 | 35 | 13 | | Art.3.3 |
| REF60.00.01.018 | TYPE A | 18mm | - | 14 | 12 | 15 | 140 | 35 | 24 | | Art.3.3 |
| REF60.00.01.034 | TYPE A | 3/4" | - | 14 | 12 | 15 | 140 | 35 | 24 | | Art.3.3 |
| REF60.00.01.022 | TYPE A | 22mm 7/8" | - | 17 | 18 | 18 | 160 | 45 | 40 | | Art.3.3 |
| REF60.00.01.028 | TYPE A | 28mm | - | 20 | 18 | 18 | 160 | 45 | 50 | -40/ +150 | Art.3.3 |
| REF60.00.01.118 | TYPE A | 1-1/8" | - | 20 | 18 | 18 | 160 | 45 | 50 | | Art.3.3 |
| REF60.00.02.014 | TYPE B | - | 1/4" | - | 10 | 15 | 77 | 30 | 0.8 | | Art.3.3 |
| REF60.00.02.038 | TYPE B | - | 3/8" | - | 10 | 15 | 77 | 35 | 0.8 | | Art.3.3 |
| REF60.00.02.127 | TYPE B | - | 1/2" | - | 10 | 15 | 85 | 35 | 3.5 | | Art.3.3 |
| REF60.00.02.058 | TYPE B | - | 5/8" | - | 12 | 15 | 85 | 45 | 3.5 | | Art.3.3 |
| REF60.00.03.014 | TYPE C | 1/4" | 1/4" | - | 10 | 15 | 101 | 30 | 0.8 | | Art.3.3 |
| REF60.00.03.038 | TYPE C | 3/8" | 3/8" | - | 10 | 15 | 101 | 35 | 0.8 | | Art.3.3 |
| REF60.00.03.127 | TYPE C | 1/2" | 1/2" | - | 10 | 15 | 112 | 35 | 3.5 | | Art.3.3 |
| REF60.00.03.058 | TYPE C | 5/8" | 5/8" | - | 12 | 15 | 112 | 45 | 3.5 | | Art.3.3 |
| REF60.00.04.014 | TYPE D | - | 1/4" (M/F) | - | 10 | 15 | 77 | 30 | 0.8 | | Art.3.3 |
| REF60.00.04.038 | TYPE D | - | 3/8" (M/F) | - | 12 | 15 | 77 | 35 | 0.8 | | Art.3.3 |

Moisture contained in the fluid (p.p.m.)

Colour Refrigerant fluid

| | R22 | R134a | R404a | R407c | R410a | R507 |
|--------|-----|-------|-------|-------|-------|------|
| Green | <60 | <75 | <30 | <30 | <30 | <30 |
| Yellow | >60 | >75 | >30 | >30 | >30 | >30 |

 Refrigera presents a new line of solenoid valves that have been designed to avoid the leaks from the circuit and to ensure the maximum reliability. Valves are two-way normally closed. Direct action solenoid valves do not require a minimum pressure to operate. Guided-diaphragm pilot-operated solenoid valves need almost a pressure of 0,05 bars to operate.

 Refrigera Srl presenta una nuova linea di elettrovalvole, progettate per evitare le perdite di energia dal circuito e per garantire la massima affidabilità. Le valvole sono a due vie normalmente chiuse. Le elettrovalvole ad azione diretta non richiedono una pressione minima per il funzionamento. Le versioni elettro-pilotate a membrana richiedono una pressione minima nell'impianto di 0,05 bar.

 Refrigera präsentiert eine neue Linie von Magnetventilen, entworfen, um die Verluste in der Schaltung zu beseitigen eingeführt und sorgt so für maximale Sicherheit. Es handelt sich um Zweiweg-Ventile, die normal geschlossen werden. Direktwirkende Magnetventile benötigen für den Betrieb keinen Mindestdruck. Magnetventile mit pilotgesteuerter geführter Membran benötigen für den Betrieb einen Druck von 0,05 bar

 Refrigera présente une nouvelle gamme d'électrovanne qui ont été conçus pour éviter les fuites du circuit et de garantir la fiabilité maximale. Les vannes sont deux voies normalement fermées. Direct électrovanne d'action n'ont pas besoin d'une pression minimum pour fonctionner. Guidées membrane électrovanne-pilotes exploités besoin de presque une pression de 0,05 bars pour fonctionner.

 Refrigera presenta una nueva línea de válvulas de solenoide diseñadas para evitar las pérdidas del circuito, asegurando así la máxima confiabilidad. Las válvulas son de dos vías normalmente cerradas. Las válvulas solenoide de acción directa no requieren una presión mínima para operar. Las válvulas de solenoide operadas por piloto necesitan una presión de 0,05 para operar.

 Refrigera apresenta uma nova linha de válvulas de solenoide destinadas a evitar perdas do circuito, assegurando assim a máxima fiabilidade. As válvulas de duas vias normalmente fechadas. As válvulas solenóides actuam directa não exigem uma alta pressão para operar. As válvulas de solenoide piloto-operada requerem uma pressão de 0,05 bar para operar.

 Refrigeraは回路の漏れを防止し、最大の信頼性を確保するように設計されたバルブの新しい範囲を提示します。二方弁は通常閉じています。直接行動ソレノイドが動作するための最低圧力を必要としません。ガイド付きソレノイドパイロット式ダイヤフラムが動作するには0.05バルブのほぼ圧力を必要としています。

 Холодильные Srl представляет новую линейку электромагнитных клапанов, предназначенных для предотвращения потерь энергии из контура и для обеспечения максимальной надежности. Клапаны имеют два пути нормально закрытый. Прямое действия клапаны не требуют минимального давления для операции. Версии электроуправляемых мембран требуется минимальное давление 0,05 бар.

Solenoid Valve

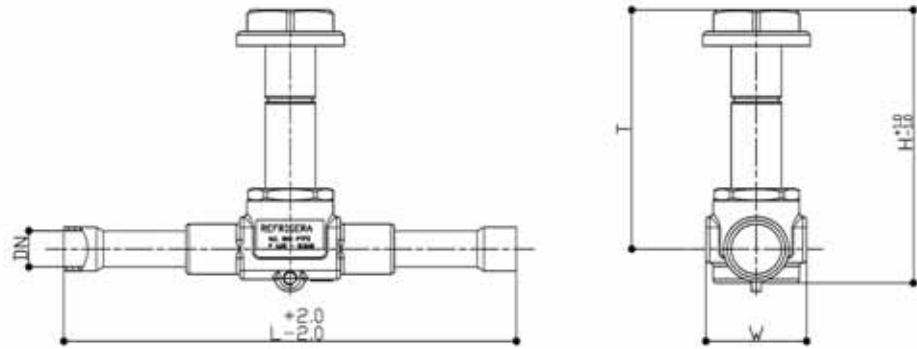

| Code | Connection | | NB mm | Kv m³/h ΔP:1bar | H mm | T mm | L mm | W mm | WPressures | | | WTemp °C | P.E.D. Group2 fluids |
|---|------------|-------------|----------|-----------------------|---------|---------|---------|---------|------------|-------------|-----------|-------------|----------------------------|
| | ODS | SAE | | | | | | | Min bar | MOPD bar | PS bar | | |
| Direct Action, 2/2Way, Normally Closed | | | | | | | | | | | | | |
| REF15.022.01.014 | 1/4" | | 2,2 | 0,15 | 77,6 | 65,6 | 123 | 24,5 | 0 | 21 | 45 | -35/ +110 | Art.3.3 |
| REF15.030.01.014 | 1/4" | | 3 | 0,23 | 77,6 | 65,6 | 123 | 24,5 | 0 | 21 | 45 | | Art.3.3 |
| REF15.030.01.038 | 3/8" | | 3 | 0,23 | 77,6 | 65,6 | 126 | 24,5 | 0 | 21 | 45 | | Art.3.3 |
| REF15.030.01.010 | 10mm | | 3 | 0,23 | 77,6 | 65,6 | 126 | 24,5 | 0 | 21 | 45 | | Art.3.3 |
| REF15.025.02.014 | | 1/4" | 2,5 | 0,175 | 77,6 | 65,6 | 58 | 24,5 | 0 | 21 | 45 | Art.3.3 | |
| REF15.030.02.038 | | 3/8" | 3 | 0,23 | 77,6 | 65,6 | 65 | 24,5 | 0 | 21 | 45 | Art.3.3 | |
| Diaphragm Servo Controlled, 2/2Way, Normally Closed | | | | | | | | | | | | | |
| REF15.065.01.038 | | 3/8" | 6,5 | 0,8 | 85,9 | 72,4 | 126 | 29,5 | 0,05 | 21 | 45 | -35/ +110 | Art.3.3 |
| REF15.065.01.010 | | 10mm | 6,5 | 0,8 | 85,9 | 72,4 | 126 | 29,5 | 0,05 | 21 | 45 | | Art.3.3 |
| REF15.065.01.012 | | 12mm | 6,5 | 0,8 | 85,9 | 72,4 | 128 | 29,5 | 0,05 | 21 | 45 | | Art.3.3 |
| REF15.065.01.127 | | 1/2" | 6,5 | 0,8 | 85,9 | 72,4 | 128 | 29,5 | 0,05 | 21 | 45 | | Art.3.3 |
| REF15.125.01.012 | | 12 | 12,5 | 2,2 | 85,9 | 72,4 | 128 | 46 | 0,05 | 21 | 45 | Art.3.3 | |
| REF15.125.01.127 | | 1/2" | 12,5 | 2,2 | 85,9 | 72,4 | 128 | 46 | 0,05 | 21 | 45 | Art.3.3 | |
| REF15.125.01.016 | | 5/8" 16mm | 12,5 | 2,6 | 85,9 | 72,4 | 128 | 46 | 0,05 | 21 | 45 | Art.3.3 | |
| REF15.125.01.022 | | 7/8" 22mm | 12,5 | 2,6 | 85,9 | 72,4 | 128 | 46 | 0,05 | 21 | 45 | Art.3.3 | |
| REF15.165.01.016 | | 5/8" 16mm | 16,5 | 3,8 | 94 | 77,5 | 175 | | 0,05 | 21 | 45 | Art.3.3 | |
| REF15.165.01.034 | | 3/4" | 16,5 | 4,8 | 94 | 77,5 | 175 | | 0,05 | 21 | 45 | Art.3.3 | |
| REF15.165.01.022 | | 7/8" 22mm | 16,5 | 5,7 | 94 | 77,5 | 180 | | 0,05 | 21 | 45 | Art.3.3 | |
| REF15.165.01.118 | | 1-1/8" 35mm | 16,5 | 5,7 | 94 | 77,5 | 216 | | 0,05 | 21 | 45 | Art.3.3 | |
| REF15.255.01.118 | | 1-1/8" 35mm | 25,5 | 10 | 94 | 77,5 | 250 | | 0,05 | 21 | 45 | Art.3.3 | |
| REF15.255.01.035 | | 1-1/8" 35mm | 25,5 | 10 | 94 | 77,5 | 292 | | 0,05 | 21 | 45 | Art.3.3 | |
| REF15.065.02.038 | | 3/8" | 6,5 | 0,8 | 85,9 | 72,4 | 68 | 29,5 | 0,05 | 21 | 45 | Art.3.3 | |
| REF15.065.02.127 | | 1/2" | 6,5 | 0,8 | 85,9 | 72,4 | 72 | 29,5 | 0,05 | 21 | 45 | Art.3.3 | |
| REF15.125.02.127 | | 1/2" | 12,5 | 2,2 | 85,9 | 72,4 | 100 | 46 | 0,05 | 21 | 45 | Art.3.3 | |
| REF15.125.02.058 | | 5/8" | 12,5 | 2,2 | 85,9 | 72,4 | 106 | 46 | 0,05 | 21 | 45 | Art.3.3 | |
| REF15.165.02.058 | | 5/8" | 16,5 | 3,8 | 85,9 | 72,4 | 120 | | 0,05 | 21 | 45 | Art.3.3 | |
| REF15.165.02.034 | | 3/4" | 16,5 | 4,8 | 85,9 | 72,4 | 124 | | 0,05 | 21 | 45 | Art.3.3 | |

Accessories

| Code | Voltage (V) | Frequency Hz | Power VA |
|------------------|----------------|-----------------|-------------|
| | | | |
| REF15.000.00.230 | 220 / 230 | 50 / 60 | 21 |

Code

REF15.000.00.CON Standard Connector



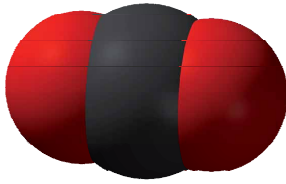

Carbon Dioxide Molecule

“To prevent environmental threats many researchers and manufacturers reconsider natural refrigerants”

R744-CO₂

The use of CO₂ as a refrigerant dates back more than a century, but it fell out of favor in the air-conditioning and refrigeration industry with the development of chlorofluorocarbons (CFCs) in the 1930s. However, in the 1980s, scientists identified harming the ozone layer and global warming as major environmental threats, and leading many researchers and manufacturers to reconsider “natural” refrigerants such as CO₂, because these substances have negligible direct global-warming impact and ozone-depletion potential.

Advantages of CO₂ as a refrigerant:

- A stable substance**
- Minimal environmental impact**
 - Ozone depletion potential = 0
 - Global warming potential = 1
- Non flammable and non toxic**
- Compatible with system materials and lubricants**
- High cooling capacity**
 - e.g. up to 6 times the capacity of R404A
 - Smaller compressor displacement and smaller pipe sizes
- High heat transfer**
 - Smaller evaporators and condensers are possible
- Low viscosity**
 - Less pipe work pressure drop
- Less sensitive to pipe work pressure drops**

New concepts of high-side pressure control in what came to be called a “transcritical” cycle were devised in early patent applications by Gustav Lorentzen, professor at Norwegian University of Science and Technology and his co-workers from 2003 and later in commercial refrigeration systems. The pressure level in these system will be quite high (around 30-130 bar). Nevertheless smaller volumes, the stored explosion energy in CO₂ piping and components is not much different from a conventional plant.

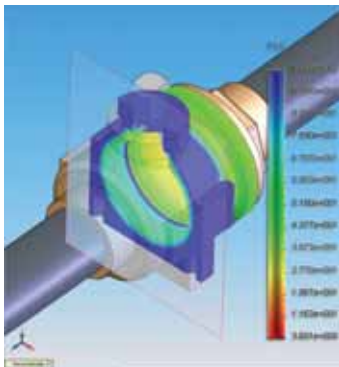

Testing Results of a CO₂ component

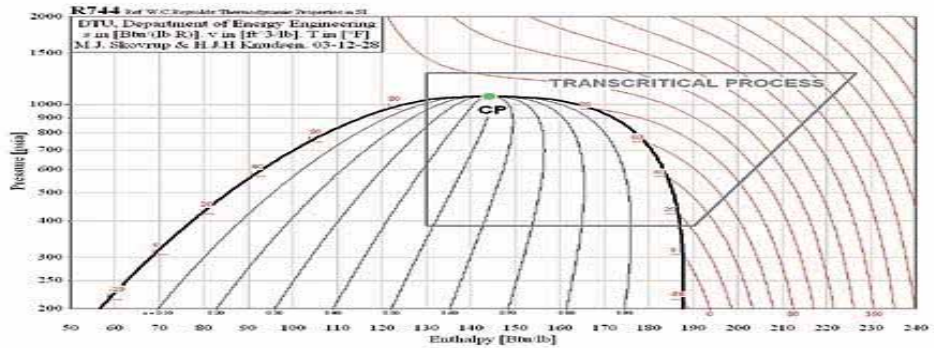

Components CO₂ Suitable

for CO₂ normal cycles, Refrigera has been designed components able to fit the properties of CO₂ and so used seats and gaskets made of appropriate materials.



Safety Changeover Device CO₂ suitable

Then, for the range of products suitable for CO₂ transcritical cycles, due to operational pressures certified of up to 100 bars, Refrigera has been put into action a further effort:

CO₂ -120 bar systems require highly resistant components that have been developed from the company to serial production in a wide range: from ball valves to check valves and from 6mm to 35mm diameters.

These valves, that operate under a higher pressure than those of conventional fluorocarbon-based vapor compression systems, have been engaged the technical staff to become more rigorous in monitoring leaks and increase the burst tests.

Refrigeria Industriale SRL preferred mounting stainless steel tubes instead of copper connections due to high yield strength and low plastic deformation of the material. On the other side, this kind of tubes have the little inconvenience to force the field personnel to execute butt-welding-joints. Refrigera[®] valves could be assembled alternatively with new high resistance copper alloy—connections.

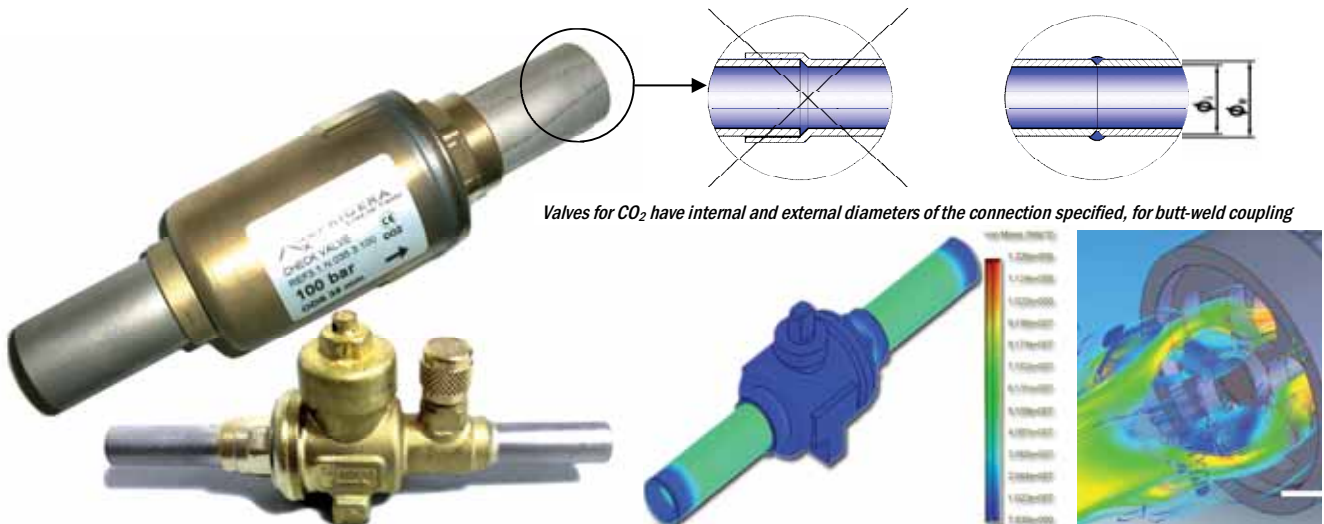



Valves for CO₂ have internal and external diameters of the connection specified, for butt-weld coupling

 Valves are fitted with special seals suitable for R744 and are guaranteed for operating pressures up to 52bar. Our bi-flow system allows the mounting of the valve without taking into consideration the direction of the flow. The small equalization hole on the sphere will allow the valve to support the gas pressure without stressing other components.

 Le valvole sono dotate di guarnizioni speciali idonee per R744 e sono garantite per pressioni di esercizio fino a 52bar. Il brevettato sistema bidirezionale permette di montare la valvola indipendentemente dalla direzione del flusso. Il piccolo foro sulla sfera fa sì che la valvola possa sopportare la pressione del gas senza sollecitare i sedgi di tenuta.

 Die Ventile sind mit speziellen, für R744 geeignete Dichtungen ausgerüstet und werden für einen Betriebsdruck bis 52 Bar garantiert. Das patentierte Bi-Flow-System ermöglicht die Montage des Ventils unabhängig von der Strömungsrichtung. Die kleine Bohrung auf der Kugel sorgt dafür, dass das Ventil dem Gasdruck standhält ohne die Dichtungssitze zu belasten.

 Les vannes sont équipées de joints spéciaux appropriés pour le gaz R744 et sont garantis pour des pressions jusqu'à 52bar. Notre système bi-directionnel permet d'installer la vanne sans prendre en compte la direction du flux. Le petit trou permet à la vanne de supporter la pression du gaz utilisé sans trop solliciter les autres composants.

 Las válvulas están dotadas de guarniciones especiales idóneas para R744 y están garantizadas para presiones hasta 52 bar. El sistema bidireccional patentado permite montar la válvula independientemente de la dirección del flujo. El pequeño orificio sobre la esfera que hace que la válvula pueda soportar la presión del gas sin presionar los asientos de contención.

 As válvulas possuem vedações especiais apropriadas para R744 e são garantidas para pressões de exercício até 52 bar. O sistema bidireccional patentado permite de montar a válvula independentemente da direção do fluxo. O pequeno orificio sobre a esfera faz com a válvula possa suportar a pressão do gás sem forçar as vedações.

 バルブは、R744に適した特別なシールによってフィットされ、最大52barまでのオペレーション・プレッシャーに対して保証されています。弊社バイ・フロー・システムは、フローの方向を考慮に入れないバルブのマウンティングを可能にします。スフィア上の小さいコライゼーション・ホールが、他のコンポーネントをストレスさせることなく、バルブがガス・プレッシャーをサポートすることを、可能にします。

 Клапаны оснащены специальными уплотнениями для R744 и гарантированы в давлениях до 52bar. Наша двунаправленная система позволяет монтировать клапан без учёта направления потока. Небольшое отверстие на шаре позволяет клапану выдерживать давление газа без нагрузки на остальной материал.

subcritical R744 Ball Valve

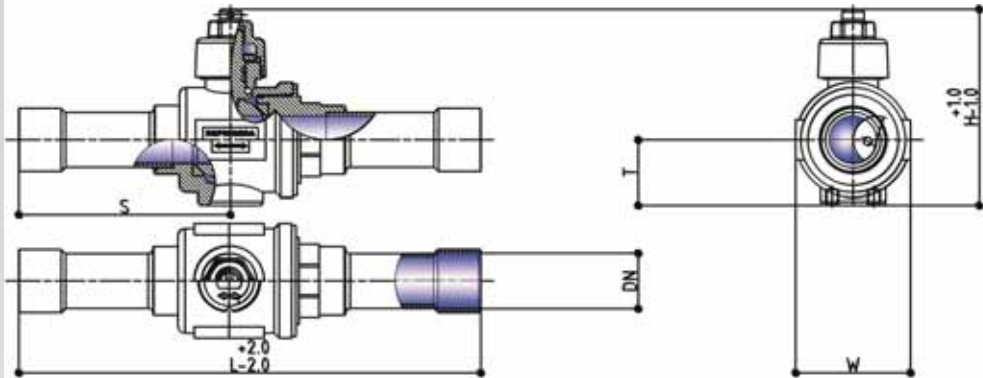
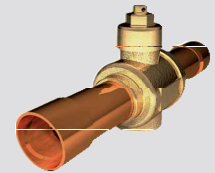



| Code | Connection | Weight | Sphere passage | Length | Height | Wide | S | T | Kv | WTemp | P.E.D. |
|---------------------|-------------|--------|----------------|--------|--------|--------|--------|--------|----------------|-----------|---------------|
| REF | DN | (g) | Ø(mm) | L (mm) | H (mm) | W (mm) | S (mm) | T (mm) | ΔP:1bar (m³/h) | °C | Group2 fluids |
| REF1.1.N.A.006.1.52 | 6mm | 110 | 8 | 126 | 40 | 24 | 60 | 12 | 1,0 | | Art.3.3 |
| REF1.1.N.A.006.2.52 | 1/4" | 110 | 8 | 126 | 40 | 24 | 60 | 12 | 1,0 | | Art.3.3 |
| REF1.1.N.A.008.3.52 | 8mm 5/16" | 110 | 8 | 126 | 40 | 24 | 60 | 12 | 1,0 | | Art.3.3 |
| REF1.1.N.A.010.1.52 | 10mm | 110 | 8 | 132 | 40 | 24 | 63 | 12 | 2,4 | | Art.3.3 |
| REF1.1.N.A.010.2.52 | 3/8" | 110 | 8 | 132 | 40 | 24 | 63 | 12 | 2,4 | | Art.3.3 |
| REF1.1.N.A.012.1.52 | 12mm | 120 | 8 | 140 | 40 | 24 | 67 | 12 | 2,7 | | Art.3.3 |
| REF1.1.N.A.012.2.52 | 1/2" | 120 | 8 | 140 | 40 | 24 | 67 | 12 | 2,7 | | Art.3.3 |
| REF1.1.N.B.015.1.52 | 15mm | 350 | 15 | 145 | 60 | 34 | 68 | 17 | 12,5 | | Art.3.3 |
| REF1.1.N.B.016.3.52 | 16mm 5/8" | 350 | 15 | 145 | 60 | 34 | 68 | 17 | 13 | -40/ +150 | Art.3.3 |
| REF1.1.N.B.018.1.52 | 18mm | 350 | 15 | 145 | 60 | 34 | 68 | 17 | 14 | | Art.3.3 |
| REF1.1.N.B.018.2.52 | 3/4" | 350 | 15 | 145 | 60 | 34 | 68 | 17 | 14 | | Art.3.3 |
| REF1.1.N.C.022.3.52 | 22mm 7/8" | 720 | 19 | 185 | 80 | 46 | 85 | 26 | 24 | | Art.3.3 |
| REF1.1.N.D.028.1.52 | 28mm | 750 | 25 | 185 | 85 | 51 | 90 | 28 | 40 | | Art.3.3 |
| REF1.1.N.D.028.2.52 | 1-1/8" | 750 | 25 | 185 | 85 | 51 | 90 | 28 | 40 | | Art.3.3 |
| REF1.1.N.E.035.3.52 | 35mm 1-3/8" | 1370 | 32 | 205 | 105 | 66 | 95 | 35 | 67,3 | | Class I |
| REF1.1.N.F.042.1.52 | 42mm | 2440 | 40 | 240 | 125 | 76 | 115 | 48 | 98 | | Class I |
| REF1.1.N.F.042.2.52 | 1-5/8" | 2440 | 40 | 240 | 125 | 76 | 115 | 48 | 98 | | Class I |
| REF1.1.N.G.054.3.52 | 54mm 2-1/8" | 3360 | 50 | 270 | 130 | 90 | 133 | 45 | 190 | | Class I |

 Valves are fitted with special seals suitable for R744 and are guaranteed for operating pressures up to 52bar. Our bi-flow system allows the mounting of the valve without taking into consideration the direction of the flow. Valves with access port are available. Up to diameter 3/4", schrader port is forged together with the valve-body.

 Le valvole sono dotate di guarnizioni speciali idonee per R744 e sono garantite per pressioni di esercizio fino a 52bar. Il brevettato sistema bidirezionale permette di montare la valvola indipendentemente dalla direzione del flusso. Sono disponibili anche con la valvolina di pre-carica. Nei diametri fino ai 3/4" è fornita già stampata assieme con il corpo valvola.

 Die Ventile sind mit speziellen, für R744 geeignete Dichtungen ausgerüstet und werden für einen Betriebsdruck bis 52 Bar garantiert. Das patentierte Biflow-System ermöglicht die Montage des Ventils unabhängig von der Strömungsrichtung. Sie sind auch mit Vorfüllventil lieferbar. Bei den Durchmessern bis 3/4" wird es bereits zusammen mit dem Ventilkörper gegossen, geliefert.

 Les vannes sont équipées de joints spéciaux appropriés pour le gaz R744 et sont garantis pour des pressions jusqu'à 52bar. Notre système bi-directionnel permet d'installer la vanne sans prendre en compte la direction du flux; Est également à disposition la vanne avec la schrader sur commande. Jusqu'à 3/4", le port schrader est intégré dans le corps de la vanne.

 Las válvulas están dotadas de guarniciones especiales idóneas para R744 y están garantizadas para presiones hasta 52 bar. El sistema bidireccional patentado permite montar la válvula independientemente de la dirección del flujo. Están disponibles también aquellas con puerto de acceso. Para los diámetros de hasta 3/4" viene ya ensamblada al cuerpo de la válvula.

 As válvulas possuem vedações especiais apropriadas para R744 e são garantidas para pressões de exercício até 52 bar. O sistema bidirecional patentado permite de montar a válvula independentemente da direção do fluxo. O pequeno orifício sobre a esfera faz com a válvula possa suportar a pressão do gás sem forçar as vedações.

 バルブは、R744に適した特別なシールによってフィットされ、最大52バーまでのオペレーション・プレッシャーに対して保証されています。弊社バイ・フロー・システムは、フローの方向を考慮に入れないバルブのマウンティングを可能にします。アクセス・ポートを伴うバルブが入手可能です。最大直径3/4インチ、シュレーダー・ポートが、バルブ・ボディとフォージ結合されています。

 Клапаны оснащены специальными уплотнениями для R 744 и гарантированы в давлениях до 52bar. Наша двунаправленная система позволяет монтировать клапан без учёта направления потока. Также имеются клапаны с вентилем предварительной загрузки уже поставленным в тело, размером до 3/4".

subcritical R744 Schrader™-Port Ball Valve

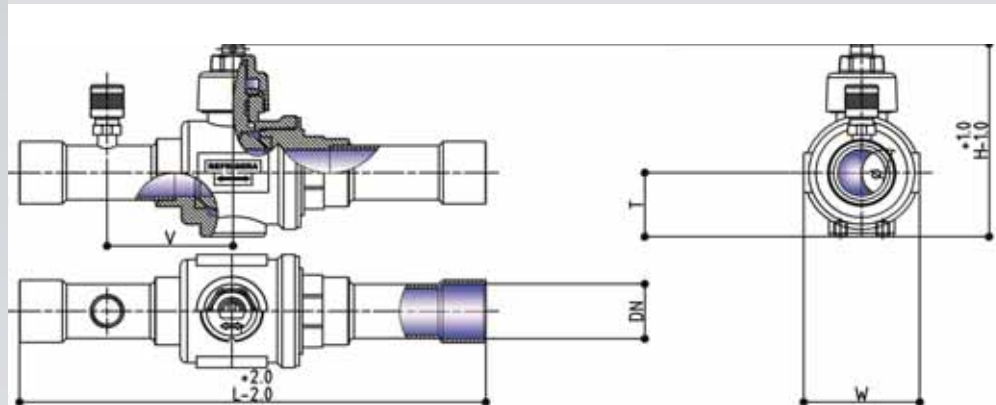
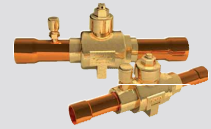



| Code | Connection | Weight | Sphere passage | Length | Height | Wide | V | T | Kv | WTemp | P.E.D. |
|---------------------|-------------|--------|----------------|--------|--------|--------|--------|--------|----------------|-----------|---------------|
| REF | DN | (g) | Ø(mm) | L (mm) | H (mm) | W (mm) | V (mm) | T (mm) | ΔP:1bar (m³/h) | °C | Group2 fluids |
| REF1.1.S.A.006.1.52 | 6mm | 290 | 10 | 126 | 55 | 33 | 25 | 15 | 1,0 | | Art.3.3 |
| REF1.1.S.A.006.2.52 | 1/4" | 290 | 10 | 126 | 55 | 33 | 25 | 15 | 1,0 | | Art.3.3 |
| REF1.1.S.A.008.3.52 | 8mm 5/16" | 290 | 10 | 132 | 55 | 33 | 25 | 15 | 1,0 | | Art.3.3 |
| REF1.1.S.A.010.1.52 | 10mm | 290 | 10 | 132 | 55 | 33 | 25 | 15 | 2,4 | | Art.3.3 |
| REF1.1.S.A.010.2.52 | 3/8" | 290 | 10 | 132 | 55 | 33 | 25 | 15 | 2,4 | | Art.3.3 |
| REF1.1.S.A.012.1.52 | 12mm | 290 | 10 | 140 | 55 | 33 | 25 | 15 | 2,7 | | Art.3.3 |
| REF1.1.S.A.012.2.52 | 1/2" | 290 | 10 | 140 | 55 | 33 | 25 | 15 | 2,7 | | Art.3.3 |
| REF1.1.S.B.015.1.52 | 15mm | 390 | 15 | 153 | 60 | 34 | 24 | 17 | 12,5 | | Art.3.3 |
| REF1.1.S.B.016.3.52 | 16mm 5/8" | 390 | 15 | 153 | 60 | 34 | 24 | 17 | 13 | -40/ +150 | Art.3.3 |
| REF1.1.S.B.018.1.52 | 18mm | 390 | 15 | 153 | 60 | 34 | 24 | 17 | 14 | | Art.3.3 |
| REF1.1.S.B.018.2.52 | 3/4" | 390 | 15 | 153 | 60 | 34 | 24 | 17 | 14 | | Art.3.3 |
| REF1.1.S.C.022.3.52 | 22mm 7/8" | 730 | 19 | 185 | 80 | 46 | 52 | 26 | 24 | | Art.3.3 |
| REF1.1.S.D.028.1.52 | 28mm | 760 | 25 | 185 | 85 | 51 | 54 | 28 | 40 | | Art.3.3 |
| REF1.1.S.D.028.2.52 | 1-1/8" | 760 | 25 | 185 | 85 | 51 | 54 | 28 | 40 | | Art.3.3 |
| REF1.1.S.E.035.3.52 | 35mm 1-3/8" | 1380 | 32 | 205 | 105 | 66 | 56 | 35 | 67,3 | | Class I |
| REF1.1.S.F.042.1.52 | 42mm | 2450 | 40 | 240 | 123 | 76 | 68 | 48 | 98 | | Class I |
| REF1.1.S.F.042.2.52 | 1-5/8" | 2450 | 40 | 240 | 123 | 76 | 68 | 48 | 98 | | Class I |
| REF1.1.S.G.054.3.52 | 54mm 2-1/8" | 3410 | 50 | 270 | 130 | 90 | 80 | 45 | 190 | | Class I |

 Valves are fitted with special seals suitable for R744 and are guaranteed for operating pressures up to 52bar. Incoming capacity comes from the vertical Tube (always open) and valve allows you to redirect the flow either along one of the two horizontal output directions.

 Le valvole sono dotate di guarnizioni speciali idonee per R744 e sono garantite per pressioni di esercizio fino a 52bar. La capacità in entrata proviene dal tubo verticale (sempre aperto) e la valvola consente di reindirizzare il flusso orizzontalmente lungo una delle due sezioni di scarico.

 Die Ventile sind mit speziellen, für R744 geeignete Dichtungen ausgerüstet und werden für einen Betriebsdruck bis 52 Bar garantiert. Die Eintrittskapazität wird durch das vertikale Rohr (immer offen) gegeben, das Ventil ermöglicht den horizontalen Durchfluss entlang einem der zwei Ablaufbereiche weiterzuleiten.

 Les vannes sont équipées de joints spéciaux appropriés pour le gaz R744 et sont garantis pour des pressions jusqu'à 52bar. La capacité est transportée par le conduit vertical (toujours ouvert) et la vanne permet de rediriger le flux le long d'une des deux sections horizontales d'échappement.

 Las válvulas están dotadas de guarniciones especiales idóneas para R744 y están garantizadas para presiones hasta 52 bar. La capacidad de entrada proviene del tubo vertical (siempre abierto) y la válvula consiente de redireccionar el flujo horizontalmente a lo largo de una de las secciones de descarga.

 As válvulas possuem vedações especiais apropriadas para R744 e são garantidas para pressões de exercício até 52 bar. O fluxo de entrada é proveniente do tubo vertical (sempre aberto) e a válvula permite redirecionar o fluxo horizontal ao longo de uma das duas seções de descarga.

 バルブは、R744に適した特別なシールによってフィットされ、最大52バーまでのオペレーション・プレッシャーに対して保証されています。入来キャパシティーは、垂直チューブより浸入します（常時開口）。バルブにより、フローをふたつの水平アウトプットのうちのどちらかひとつに沿うよう、変更することが可能です。

 Клапаны оснащены специальными уплотнениями для R 744 и гарантированы в давлениях до 52bar. Поток поступает из вертикальной трубы (всегда открытая) и клапан позволяет направить его вдоль одной из двух горизонтально расположенных труб.

subcritical R744 3Way Ball Valve

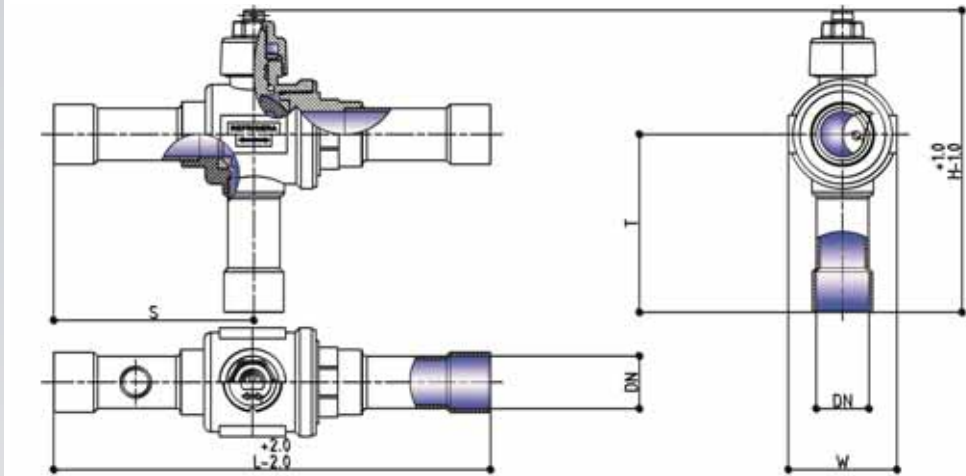
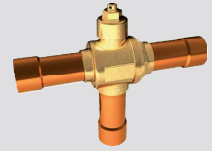

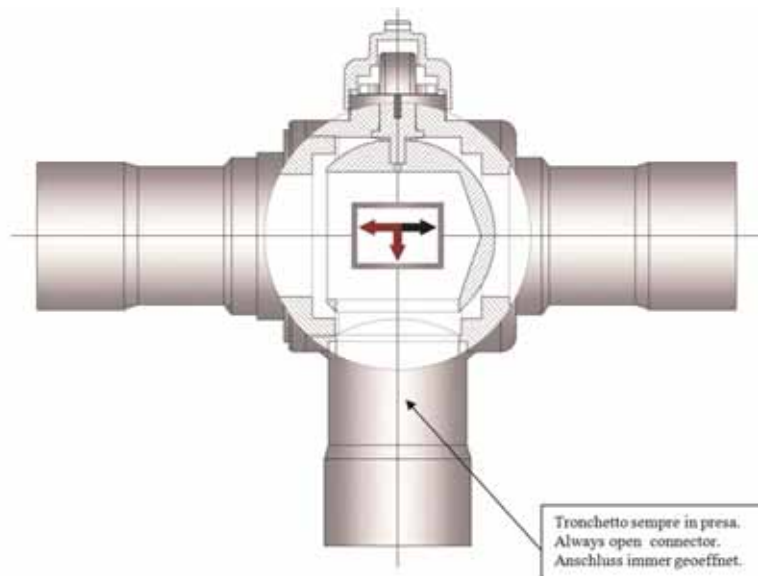

| Code | Connection | Weight | Sphere passage | Length | Height | Wide | S | T | Kv | WTemp | P.E.D. |
|-----------------------|-------------|--------|----------------|--------|--------|--------|--------|--------|----------------|-----------|---------------|
| REF | DN | (g) | Ø(mm) | L (mm) | H (mm) | W (mm) | S (mm) | T (mm) | ΔP:1bar (m³/h) | °C | Group2 fluids |
| REF1.1.N.B.015.1.M.52 | 15mm | 360 | 15 | 148 | 109 | 34 | 68 | 61 | 5,5 | | Art.3.3 |
| REF1.1.N.B.016.3.M.52 | 16mm 5/8" | 360 | 15 | 148 | 109 | 34 | 68 | 61 | 5,6 | | Art.3.3 |
| REF1.1.N.B.018.1.M.52 | 18mm | 360 | 15 | 148 | 109 | 34 | 68 | 61 | 5,8 | | Art.3.3 |
| REF1.1.N.B.018.2.M.52 | 3/4" | 360 | 15 | 148 | 109 | 34 | 68 | 61 | 5,8 | | Art.3.3 |
| REF1.1.N.C.022.3.M.52 | 22mm 7/8" | 750 | 19 | 185 | 138 | 46 | 85 | 79 | 10,3 | -40/ +150 | Art.3.3 |
| REF1.1.N.D.028.1.M.52 | 28mm | 1076 | 25 | 185 | 138 | 52 | 90 | 89 | 15,5 | | Art.3.3 |
| REF1.1.N.D.028.2.M.52 | 1-1/8" | 1076 | 25 | 185 | 146 | 52 | 90 | 89 | 15,5 | | Art.3.3 |
| REF1.1.N.E.035.3.M.52 | 35mm 1-3/8" | 1322 | 32 | 205 | 146 | 66 | 95 | 94 | 19,7 | | Class I |
| REF1.1.N.F.042.1.M.52 | 42mm | 2400 | 40 | 240 | 180 | 76 | 115 | 113 | 39,5 | | Class I |
| REF1.1.N.F.042.2.M.52 | 1-5/8" | 2400 | 40 | 240 | 180 | 76 | 115 | 113 | 39,5 | | Class I |



THE IMAGE SHOWS: The three-way valve receive the incoming flow through the vertical Tube (always open) and allows to redirect the flow either along one of the two horizontal output directions.

 Valves are fitted with special seals suitable for R744 and are guaranteed for operating pressures up to 52bar. Valves with access port are available. Up to diameter 3/4", schrader port is forged together with the valve-body. Incoming capacity comes from the vertical Tube (always open) and valve allows you to redirect the flow either along one of the two horizontal output directions.

 Le valvole sono dotate di guarnizioni speciali idonee per R744 e sono garantite per pressioni di esercizio fino a 52bar. Sono disponibili versioni con valvolina di precarica. Nei diametri fino ai 3/4" è fornita già stampata assieme con il corpo valvola. La capacità in entrata proviene dal tubo verticale (sempre aperto) e la valvola consente di reindirizzare il flusso orizzontalmente lungo una delle due sezioni di scarico.

 Der Standardflansch ISO-DIN 5211 ermöglicht in allen Fällen, in denen die Fernsteuerung der Öffnung und Schließung oder die Durchflussrichtung zu regeln ist, den Anschluss der Ventile an alle momentan auf dem Markt befindlichen Antriebe. Der Schaltzapfen wird mit einer Berstsicherung montiert und verfügt über eine hermetische Dichtung. Die Ventile sind mit speziellen, für R744 geeigneten Dichtungen ausgerüstet und werden für einen Betriebsdruck bis 52 Bar garantiert.

 La bride ISO-DIN 5211 standard permet de créer la paire de vannes pour tous les acteurs sur le marché aujourd'hui, pour l'utilisation de la télécommande d'ouverture et de fermeture ou de réglage de la direction de flux. Le levier est monté dans une configuration anti explosion, conçu hermétiquement avec le joint O-Ring. Les vannes sont équipées de joints spéciaux appropriés pour le gaz R744 et sont garantis pour des pressions jusqu'à 52bar. Vanalar R744 uygun özel contalar ile donatılmıştır ve 52bar kadar baskılar için garantilidir.

 La brida ISO-DIN 5211 estándar permite acopiar las válvulas con todos los actuadores presentes en el mercado en los cuales sea necesario el control a distancia de la apertura y cierre o para regular la dirección del flujo. El pomo de maniobra viene montado con configuración antideflagrante y fijado hermético. Las válvulas están dotadas de guarniciones especiales idóneas para R744 y están garantizadas para presiones hasta 52 bar.

 O flange padrão ISO-DIN 5211, permite o acoplamento das válvulas com todos os atuadores atualmente presentes no comércio para todos os casos em que for necessário controlar a distância, tanto a abertura como o fechamento ou então regular a direção do fluxo. O pivô é montado na configuração à prova de explosão e lacrado hermeticamente. As válvulas possuem vedações especiais apropriadas para R744 e são garantidas para pressões de exercício até 52 bar.

 DIN ISO-5211水準の同フランジは、市場に存在するすべてのアクチュエーターにバルブをフィットさせることを可能にします。これは、開口と閉口、あるいはフローの方向調節をリモート・コントロールする際に必要となります。レバー・シャフトが爆発防止の設定でマウントされており、完封エアタイト設計されています。バルブは、R744に適した特別なシールによってフィットされ、最大52barまでのオペレーション・プレッシャーに対し、保証されています。

 Клапаны оснащены специальными уплотнениями для R744 и гарантированы в давлениях до 52bar. Также имеются клапаны с вентилем предварительной загрузки уже поставленным в тело, размером до 3/4". Поток поступает из вертикальной трубы (всегда открытая) и клапан позволяет направить его вдоль одной из двух горизонтально расположенных труб.

subcritical R744 3Way Schrader™-Port Ball Valve

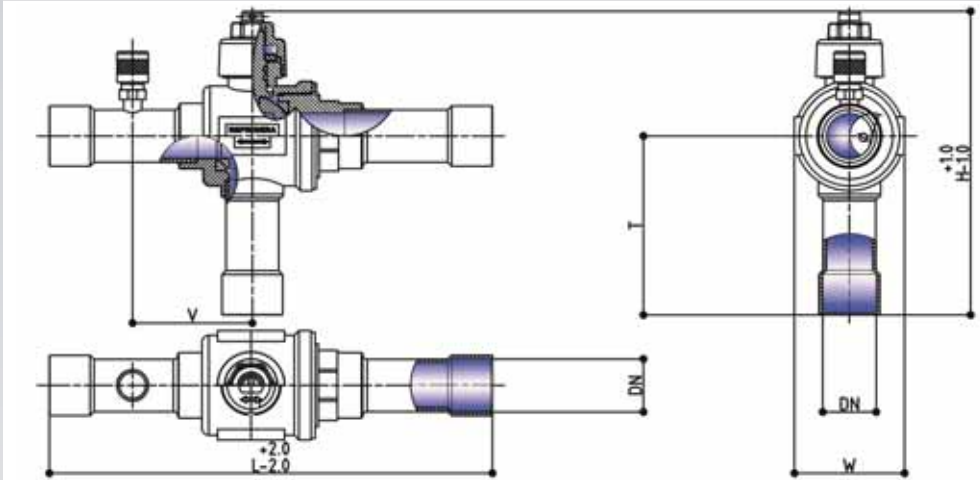
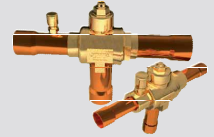



| Code | Connection | Weight | Sphere passage | Length | Height | Wide | V | T | Kv | WTemp | P.E.D. |
|-----------------------|-------------|--------|----------------|--------|--------|--------|--------|--------|----------------|-----------|---------------|
| REF | DN | (g) | Ø(mm) | L (mm) | H (mm) | W (mm) | V (mm) | T (mm) | ΔP:1bar (m³/h) | °C | Group2 fluids |
| REF1.1.S.A.006.1.M.52 | 6mm | 90 | 8 | 126 | 71 | 22 | 25 | 46 | 0,8 | | Art.3.3 |
| REF1.1.S.A.006.2.M.52 | 1/4" | 90 | 8 | 126 | 71 | 22 | 25 | 46 | 0,8 | | Art.3.3 |
| REF1.1.S.A.008.3.M.52 | 8mm 5/16" | 90 | 8 | 126 | 74 | 22 | 25 | 46 | 0,8 | | Art.3.3 |
| REF1.1.S.A.010.1.M.52 | 10mm | 108 | 8 | 132 | 74 | 22 | 25 | 48 | 1,8 | | Art.3.3 |
| REF1.1.S.A.010.2.M.52 | 3/8" | 108 | 8 | 132 | 74 | 22 | 25 | 48 | 1,8 | | Art.3.3 |
| REF1.1.S.A.012.1.M.52 | 12mm | 120 | 8 | 139 | 80 | 22 | 25 | 57 | 2,7 | | Art.3.3 |
| REF1.1.S.A.012.2.M.52 | 1/2" | 120 | 8 | 139 | 80 | 22 | 25 | 57 | 2,7 | | Art.3.3 |
| REF1.1.S.B.015.1.M.52 | 15mm | 360 | 15 | 148 | 109 | 34 | 24 | 61 | 5,5 | | Art.3.3 |
| REF1.1.S.B.016.3.M.52 | 16mm 5/8" | 360 | 15 | 148 | 109 | 34 | 24 | 61 | 5,6 | | Art.3.3 |
| REF1.1.S.B.018.1.M.52 | 18mm | 360 | 15 | 148 | 109 | 34 | 24 | 61 | 5,8 | | Art.3.3 |
| REF1.1.S.B.018.2.M.52 | 3/4" | 360 | 15 | 148 | 109 | 34 | 24 | 61 | 5,8 | -40/ +150 | Art.3.3 |
| REF1.1.S.C.022.3.M.52 | 22mm 7/8" | 750 | 19 | 185 | 138 | 46 | 35 | 79 | 10,3 | | Art.3.3 |
| REF1.1.S.D.028.1.M.52 | 28mm | 1076 | 25 | 185 | 138 | 52 | 50 | 89 | 15,5 | | Art.3.3 |
| REF1.1.S.D.028.2.M.52 | 1-1/8" | 1076 | 25 | 185 | 146 | 52 | 50 | 89 | 15,5 | | Art.3.3 |
| REF1.1.S.E.035.3.M.52 | 35mm 1-3/8" | 1322 | 32 | 205 | 146 | 66 | 64 | 94 | 19,7 | | Class I |
| REF1.1.S.F.042.1.M.52 | 42mm | 2400 | 40 | 240 | 180 | 76 | 54 | 113 | 39,5 | | Class I |
| REF1.1.S.F.042.2.M.52 | 1-5/8" | 2400 | 40 | 240 | 180 | 76 | 54 | 113 | 39,5 | | Class I |
| REF1.1.S.G.054.3.M.52 | 54mm 2-1/8" | 3386 | 50 | 270 | 204 | 90 | 80 | 119 | 73,5 | | Class I |

 Our bi-flow system allows the mounting of the valve without taking into consideration the direction of the flow. The valve allows you to redirect the flow either along one of the two horizontal output directions.

 Il brevettato sistema bidirezionale permette di montare la valvola indipendentemente dalla direzione del flusso. La valvola consente di reindirizzare il flusso orizzontalmente lungo una delle due sezioni di scarico.

 Das patentierte Biflow-System ermöglicht die Montage des Ventils unabhängig von der Strömungsrichtung. Das Ventil ermöglicht den horizontalen Durchfluss entlang einem der zwei Ablaufbereiche weiterzuleiten.

 Notre système bi-directionnel permet d'installer la vanne sans se préoccuper de la direction du flux. La vanne permet de rediriger le flux le long d'une des deux sections horizontales d'échappement.

 El sistema bidireccional patentado permite montar la válvula independientemente de la dirección del flujo. La válvula consiente de redireccionar el flujo horizontalmente a lo largo de las dos secciones de desagüe.

 O sistema bidireccional patentado permite de montar a válvula independentemente da direção do fluxo. A válvula permite redireccionar o fluxo horizontal ao longo de uma das duas seções de descarga.

 弊社バイ・フロー・システムは、フローの方向を考慮に入れないバルブのマウンティングを可能にします。バルブにより、フローをふたつの水平アウトプットのうちのどちらかひとつに沿うように、変更することが可能です。

 Наша двунаправленная система позволяет монтировать клапан без учёта направления потока. Клапан позволяет направить его вдоль одной из двух горизонтально расположенных труб.

subcritical R744 4way Ball Valve

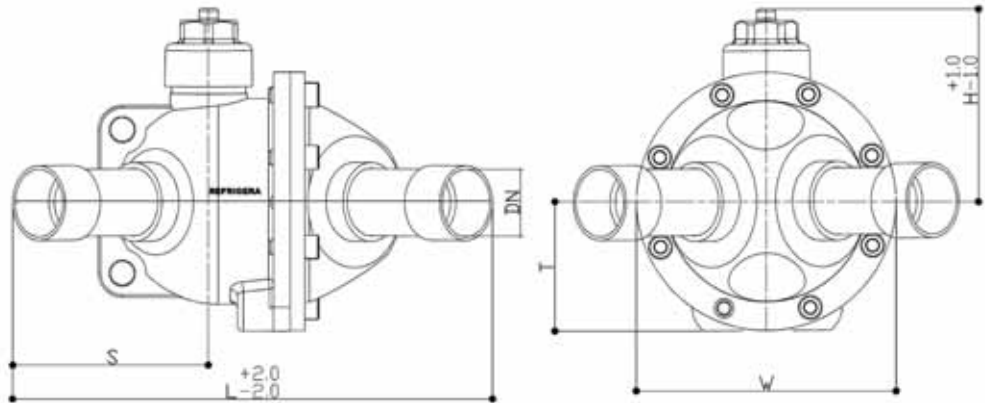
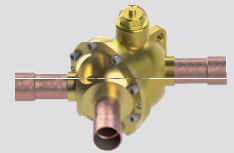

| Code | Connections Size According to ASME/ANSI B36.10 | Weight | Lenght | Lenght | Height | Height | Wide | Kvs | P.E.D. |
|--------------|--|--------|-----------|-----------|-----------|-----------|-----------|--|------------------|
| REF | DN | (g) | S (mm) | L (mm) | T (mm) | H (mm) | W (mm) | $\Delta P: 1\text{bar}$ (m^3/h) | Group2 fluids |
| REF4.0.022.3 | 22 | - | - | - | - | - | - | 12,5 | Art.3.3 |
| REF4.0.028.1 | 28 | - | - | - | - | - | - | 12,5 | Art.3.3 |
| REF4.0.028.1 | 1-1/8" | - | - | - | - | - | - | 12,5 | Art.3.3 |





THE IMAGE SHOWS: The 4-way Reversing Valve provide Heating and Cooling by reversing the flow direction of refrigerant in applications such as heat pumps or reversible air conditioning units

 The DIN ISO-5211 standard flange, allows to fit valves with all the actuators on the market, when it is necessary the remote control of opening and closing or adjusting the direction of flow.

The lever shaft is mounted in explosion-proof configuration and is hermetic airtight designed. Valves are fitted with special seals suitable for R744 and are guaranteed for operating pressures up to 52bar.

 La flangia ISO-DIN 5211 standard permette l'accoppiamento delle valvole con tutti gli attuatori attualmente presenti sul mercato per tutti i casi in cui sia necessario il controllo a distanza dell'apertura e chiusura o regolare la direzione del flusso. Il perno di manovra viene montato in configurazione antiscoopio ed è progettato a tenuta ermetica. Le valvole sono dotate di guarnizioni speciali idonee per R744 e sono garantite per pressioni di esercizio fino a 52bar.

 Der Standardflansch ISO-DIN 5211 ermöglicht in allen Fällen, in denen die Fernsteuerung der Öffnung und Schließung oder die Durchflussrichtung zu regeln ist, den Anschluss der Ventile an alle momentan auf dem Markt befindlichen Antriebe. Der Schaltzapfen wird mit einer Berstsicherung montiert und verfügt über eine hermetische Dichtung.

 La bride ISO-DIN 5211 standard permet de créer la paire de vannes pour tous les acteurs sur le marché aujourd'hui, pour tous les cas où il est nécessaire d'utiliser la télécommande d'ouverture et de fermeture ou de réglage de la direction du flux.

Le levier est monté dans une configuration anti explosion, conçu hermétiquement avec le joint O-Ring R744, compatible pour le R744.

 La brida ISO-DIN 5211 estándar permite acoplar las válvulas con todos los actuadores presentes en el mercado en los cuales sea necesario el control a distancia de la apertura y cierre o para regular la dirección del flujo. El perno de maniobra viene montado con configuración antideflagrante y fijado hermético.

 O flange padrão ISO-DIN 5211, permite o acoplamento das válvulas com todos os atuadores atualmente disponíveis no comércio para todos os casos em que for necessário controlar à distância, tanto a abertura como o fechamento ou então regular a direção do fluxo. O pivô é montado na configuração à prova de explosão e lacrado hermeticamente.

 DIN ISO-5211水準の同フランジは、市場に存在するすべてのアクチュエーターにバルブをフィットさせることを可能とします。これは、開口と閉口、あるいはフローの方向調節をリモート・コントロールする際に必要となります。レバー・シャフトが、爆発防止の設定でマウントされており、完封エアタイト設計されています。

 Стандартный фланец DIN ISO-5211 позволяет соединению клапанов со всеми приводами рынка. Полезно в тех случаях, когда нужно удаленного контроля или регулирования открытия и закрытия потока. Рычаг вала осуществляет взрывобезопасную функцию и он герметично запечатан. Клапаны оснащены специальными уплотнениями для R744 и гарантированы в давлениях до 52bar.

subcritical R744 Ball Valve fit for Actuator

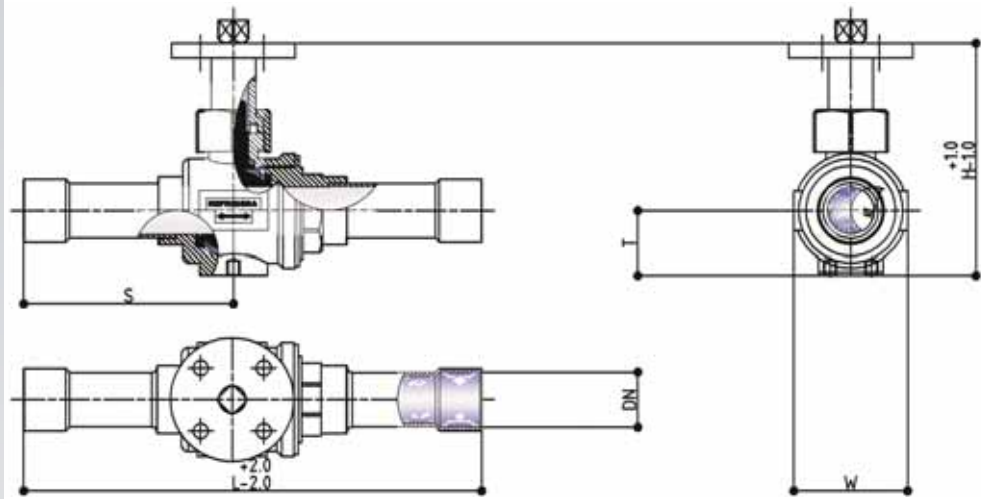



| Code | Connection | Weight | Sphere passage | Length | Height | Wide | T | Kv | WTemp | P.E.D. |
|-----------------------|-------------|--------|----------------|--------|--------|--------|--------|----------------|-----------|---------------|
| REF | DN | (g) | Ø (mm) | L (mm) | H (mm) | W (mm) | T (mm) | ΔP:1bar (m³/h) | °C | Group2 fluids |
| REF1.1.S.A.006.1.P.52 | 6mm | 90 | 10 | 126 | 107 | 22 | 15 | 1,0 | | Art.3.3 |
| REF1.1.S.A.006.2.P.52 | 1/4" | 90 | 10 | 126 | 107 | 22 | 15 | 1,0 | | Art.3.3 |
| REF1.1.S.A.008.3.P.52 | 8mm 5/16" | 90 | 10 | 126 | 107 | 22 | 15 | 1,0 | | Art.3.3 |
| REF1.1.S.A.010.1.P.52 | 10mm | 108 | 10 | 132 | 107 | 22 | 15 | 2,4 | | Art.3.3 |
| REF1.1.S.A.010.2.P.52 | 3/8" | 108 | 10 | 132 | 107 | 22 | 15 | 2,4 | | Art.3.3 |
| REF1.1.S.A.012.1.P.52 | 12mm | 120 | 10 | 139 | 107 | 22 | 15 | 2,7 | | Art.3.3 |
| REF1.1.S.A.012.2.P.52 | 1/2" | 120 | 10 | 139 | 78 | 22 | 17 | 2,7 | | Art.3.3 |
| REF1.1.N.B.015.1.P.52 | 15mm | 360 | 15 | 148 | 78 | 34 | 17 | 12,5 | | Art.3.3 |
| REF1.1.N.B.016.3.P.52 | 16mm 5/8" | 360 | 15 | 148 | 78 | 34 | 17 | 13 | | Art.3.3 |
| REF1.1.N.B.018.1.P.52 | 18mm | 360 | 15 | 148 | 78 | 34 | 17 | 14 | | Art.3.3 |
| REF1.1.N.B.018.2.P.52 | 3/4" | 360 | 15 | 148 | 78 | 34 | 17 | 14 | | Art.3.3 |
| REF1.1.S.B.015.1.P.52 | 15mm | 360 | 15 | 148 | 65 | 34 | 17 | 12,5 | | Art.3.3 |
| REF1.1.S.B.016.3.P.52 | 16mm 5/8" | 360 | 15 | 148 | 65 | 34 | 17 | 13 | -20/ +100 | Art.3.3 |
| REF1.1.S.B.018.1.P.52 | 18mm | 360 | 15 | 148 | 65 | 34 | 17 | 14 | | Art.3.3 |
| REF1.1.S.B.018.2.P.52 | 3/4" | 360 | 15 | 148 | 65 | 34 | 17 | 14 | | Art.3.3 |
| REF1.1.N.C.022.3.P.52 | 22mm 7/8" | 750 | 19 | 185 | 92 | 46 | 26 | 24 | | Art.3.3 |
| REF1.1.N.D.028.1.P.52 | 28mm | 1076 | 25 | 185 | 98 | 52 | 28 | 40 | | Art.3.3 |
| REF1.1.N.D.028.2.P.52 | 1-1/8" | 1076 | 25 | 185 | 98 | 52 | 28 | 40 | | Art.3.3 |
| REF1.1.N.E.035.3.P.52 | 35mm 1-3/8" | 1322 | 32 | 205 | 110 | 66 | 31 | 67,3 | | Class I |
| REF1.1.N.F.042.1.P.52 | 42mm | 2400 | 40 | 240 | 110 | 76 | 48 | 98 | | Class I |
| REF1.1.N.F.042.2.P.52 | 1-5/8" | 2400 | 40 | 240 | 110 | 76 | 48 | 98 | | Class I |
| REF1.1.N.G.054.3.P.52 | 54mm 2-1/8" | 3386 | 50 | 270 | 150 | 90 | 45 | 190 | | Class I |

*CONNECTION KIT ARE SOLD SEPARATELY. PLS REFER TO CONNECTION KIT PAGE

 The DIN ISO-5211 standard flange, allows to fit valves with all the actuators on the market, when it is necessary the remote control of opening and closing or adjusting the direction of flow. The lever shaft is mounted in explosion-proof configuration and is hermetic airtight designed.

 La flangia ISO-DIN 5211 standard permette l'accoppiamento delle valvole con tutti gli attuatori attualmente presenti sul mercato per tutti i casi in cui sia necessario il controllo a distanza dell'apertura e chiusura o regolare la direzione del flusso. Il perno di manovra viene montato in configurazione antisceppio ed è progettato a tenuta ermetica.

 Der Standardflansch ISO-DIN 5211 ermöglicht in allen Fällen, in denen die Fernsteuerung der Öffnung und Schließung oder die Durchflussrichtung zu regeln ist, den Anschluss der Ventile an alle momentan auf dem Markt befindlichen Antriebe. Der Schaltzapfen wird mit einer Berstsicherung montiert und verfügt über eine hermetische Dichtung.

 La bride ISO-DIN 5211 standard permet de créer la paire de vanes pour tous les acteurs sur le marché aujourd'hui, pour tous les cas où il est nécessaire d'utiliser la télécommande d'ouverture et de fermeture ou de réglage de la direction du flux. Le levier est monté dans une configuration anti explosion, conçu hermétiquement avec le joint O-Ring R744, compatible pour le R744.

 La brida ISO-DIN 5211 estándar permite acopiar las válvulas con todos los actuadores presentes en el mercado en los cuales sea necesario el control a distancia de la apertura y cierre o para regular la dirección del flujo. El perno de maniobra viene montado con configuración antideflagrante y fijado hermético.

 O flange padrão ISO-DIN 5211, permite o acoplamento das válvulas com todos os atuadores atualmente disponíveis no comércio para todos os casos em que for necessário controlar à distância, tanto a abertura como o fechamento ou então regular a direção do fluxo. O pivô é montado na configuração à prova de explosão e lacrado hermeticamente.

 DIN ISO-5211水準の同フランジは、市場に存在するすべてのアクチュエーターにバルブをフィットさせることを可能とします。これは、開口と閉口、あるいはフローの方向調節をリモート・コントロールする際に必要となります。レバー・シャフトが、爆発防止の設定でマウントされており、完封エアタイト設計されています。

 Стандартный фланец DIN ISO-5211 позволяет соединению клапанов со всеми приводами рынка. Полезно в тех случаях, когда нужно удаленно контроля или регулирования открытия и закрытия потока. Рычаг вала осуществляет взрывобезопасную функцию и он герметично запечатан.

subcritical R744 3Way B.V. fit for Actuator

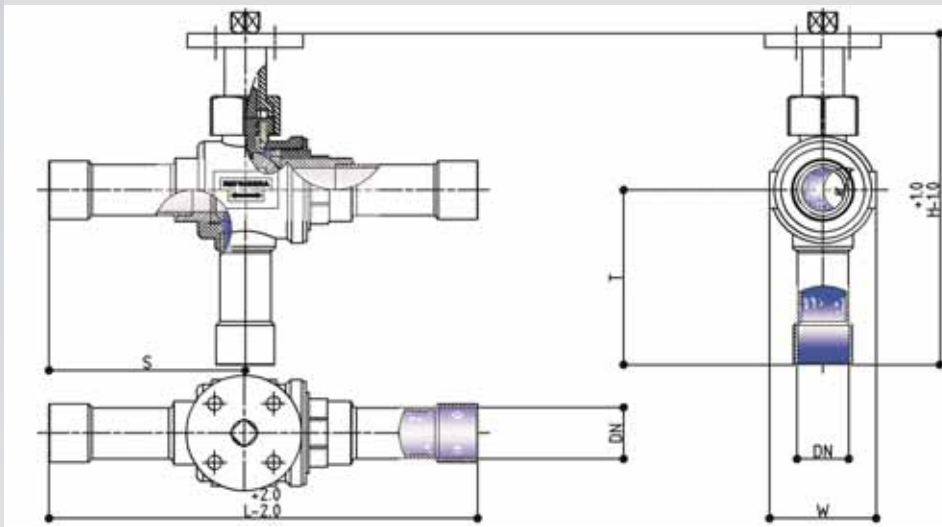



| Code | Connection | Weight | Sphere passage | Length | Height | Wide | S | T | Kv | WTemp | P.E.D. |
|-----------------------|-------------|--------|----------------|--------|--------|--------|--------|--------|----------------|-----------|---------------|
| REF | DN | (g) | Ø(mm) | L (mm) | H (mm) | W (mm) | S (mm) | T (mm) | ΔP:1bar (m³/h) | °C | Group2 fluids |
| REF1.1.S.A.006.1.MP52 | 6mm | 90 | 10 | 126 | 107 | 22 | 60 | 46 | 0,8 | | Art.3.3 |
| REF1.1.S.A.006.2.MP52 | 1/4" | 90 | 10 | 126 | 107 | 22 | 60 | 46 | 0,8 | | Art.3.3 |
| REF1.1.S.A.008.3.MP52 | 8mm 5/16" | 90 | 10 | 126 | 107 | 22 | 60 | 46 | 0,8 | | Art.3.3 |
| REF1.1.S.A.010.1.MP52 | 10mm | 108 | 10 | 132 | 107 | 22 | 63 | 48 | 1,8 | | Art.3.3 |
| REF1.1.S.A.010.2.MP52 | 3/8" | 108 | 10 | 132 | 107 | 22 | 63 | 48 | 1,8 | | Art.3.3 |
| REF1.1.S.A.012.1.MP52 | 12mm | 120 | 10 | 139 | 107 | 22 | 67 | 57 | 2,7 | | Art.3.3 |
| REF1.1.S.A.012.2.MP52 | 1/2" | 120 | 10 | 139 | 78 | 22 | 67 | 57 | 2,7 | | Art.3.3 |
| REF1.1.N.B.015.1.MP52 | 15mm | 360 | 15 | 148 | 78 | 34 | 68 | 61 | 5,5 | | Art.3.3 |
| REF1.1.N.B.016.3.MP52 | 16mm 5/8" | 360 | 15 | 148 | 78 | 34 | 68 | 61 | 5,6 | | Art.3.3 |
| REF1.1.N.B.018.1.MP52 | 18mm | 360 | 15 | 148 | 78 | 34 | 68 | 61 | 5,8 | | Art.3.3 |
| REF1.1.N.B.018.2.MP52 | 3/4" | 360 | 15 | 148 | 78 | 34 | 68 | 61 | 5,8 | | Art.3.3 |
| REF1.1.S.B.015.1.MP52 | 15mm | 360 | 15 | 148 | 109 | 34 | 68 | 61 | 5,5 | | Art.3.3 |
| REF1.1.S.B.016.3.MP52 | 16mm 5/8" | 360 | 15 | 148 | 109 | 34 | 68 | 61 | 5,6 | -20/ +100 | Art.3.3 |
| REF1.1.S.B.018.1.MP52 | 18mm | 360 | 15 | 148 | 109 | 34 | 68 | 61 | 5,8 | | Art.3.3 |
| REF1.1.S.B.018.2.MP52 | 3/4" | 360 | 15 | 148 | 109 | 34 | 68 | 61 | 5,8 | | Art.3.3 |
| REF1.1.N.C.022.3.MP52 | 22mm 7/8" | 750 | 19 | 185 | 92 | 46 | 85 | 79 | 10,3 | | Art.3.3 |
| REF1.1.N.D.028.1.MP52 | 28mm | 1076 | 25 | 185 | 98 | 52 | 90 | 89 | 15,5 | | Art.3.3 |
| REF1.1.N.D.028.2.MP52 | 1-1/8" | 1076 | 25 | 185 | 98 | 52 | 90 | 89 | 15,5 | | Art.3.3 |
| REF1.1.N.E.035.3.MP52 | 35mm 1-3/8" | 1322 | 32 | 205 | 110 | 66 | 95 | 94 | 19,7 | | Class I |
| REF1.1.N.F.042.1.MP52 | 42mm | 2400 | 40 | 240 | 110 | 76 | 115 | 113 | 39,5 | | Class I |
| REF1.1.N.F.042.2.MP52 | 1-5/8" | 2400 | 40 | 240 | 110 | 76 | 115 | 113 | 39,5 | | Class I |
| REF1.1.N.G.054.3.MP52 | 54mm 2-1/8" | 3386 | 50 | 270 | 150 | 90 | 130 | 119 | 73,5 | | Class I |

*CONNECTION KIT ARE SOLD SEPARATELY. PLS REFER TO CONNECTION KIT PAGE

 The DIN ISO-5211 standard flange, allows to fit valves with all the actuators on the market, when it is necessary the remote control of opening and closing or adjusting the direction of flow. The lever shaft is mounted in explosion-proof configuration and is hermetic airtight designed.

 La flangia ISO-DIN 5211 standard permette l'accoppiamento delle valvole con tutti gli attuatori attualmente presenti sul mercato per tutti i casi in cui sia necessario il controllo a distanza dell'apertura e chiusura o regolare la direzione del flusso. Il perno di manovra viene montato in configurazione antisceppio ed è progettato a tenuta ermetica.

 Der Standardflansch ISO-DIN 5211 ermöglicht in allen Fällen, in denen die Fernsteuerung der Öffnung und Schließung oder die Durchflussrichtung zu regeln ist, den Anschluss der Ventile an alle momentan auf dem Markt befindlichen Antriebe. Der Schaltzapfen wird mit einer Berstsicherung montiert und verfügt über eine hermetische Dichtung.

 La bride ISO-DIN 5211 standard permet de créer la paire de vannes pour tous les acteurs sur le marché aujourd'hui, pour tous les cas où il est nécessaire d'utiliser la télécommande d'ouverture et de fermeture ou de réglage de la direction du flux. Le levier est monté dans une configuration anti explosion, conçu hermétiquement avec le joint O-Ring.

 La brida ISO-DIN 5211 estándar permite acopiar las válvulas con todos los actuadores presentes en el mercado en los cuales sea necesario el control a distancia de la apertura y cierre o para regular la dirección del flujo. El perno de maniobra viene montado con configuración antideflagrante y fijado hermético.

 O flange padrão ISO-DIN 5211, permite o acoplamento das válvulas com todos os atuadores atualmente disponíveis no comércio para todos os casos em que for necessário controlar à distância, tanto a abertura como o fechamento ou então regular a direção do fluxo. O pivô é montado na configuração à prova de explosão e lacrado hermeticamente.

 DIN ISO-5211水準の同フランジは、市場に存在するすべてのアクチュエーターにバルブをフィットさせることを可能とします。これは、開口と閉口、あるいはフローの方向調節をリモート・コントロールする際に必要となります。レバー・シャフトが、爆発防止の設定でマウントされており、完封エアタイト設計されています。

 Стандартный фланец DIN ISO-5211 позволяет соединению клапанов со всеми приводами рынка. Полезно в тех случаях, когда нужно удаленного контроля или регулирования открытия и закрытия потока. Рычаг вала осуществляет взрывобезопасную функцию и он герметично запечатан.

subcritical R744 4Way B.V. fit for Actuator

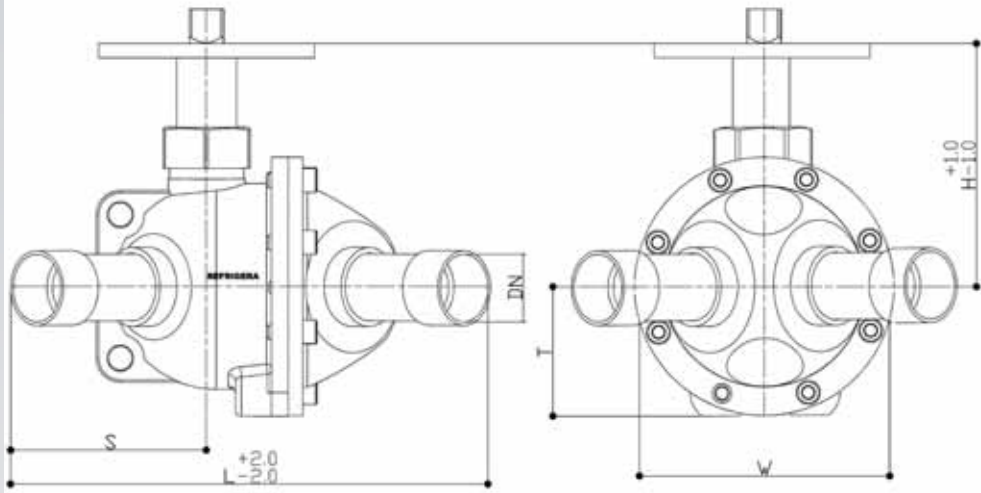
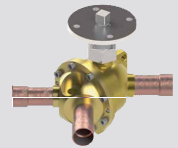

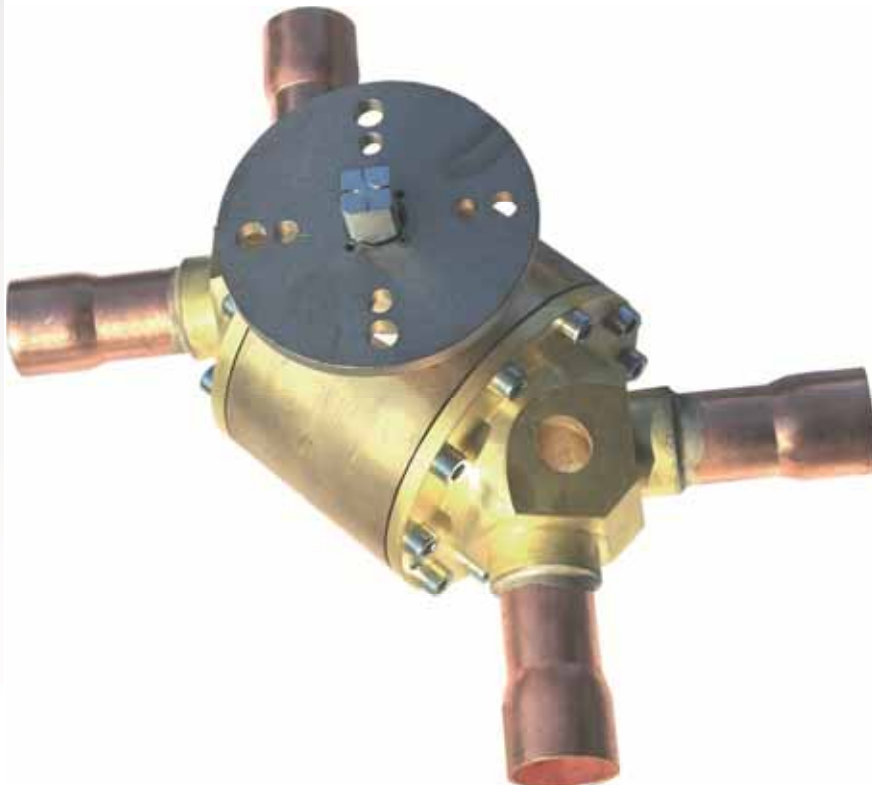

| Code | Connections Size According to ASME/ANSI B36.10 | Weight | Lenght | Lenght | Height | Height | Wide | Kvs | P.E.D. |
|----------------|--|--------|-----------|-----------|-----------|-----------|-----------|--------------------------------|------------------|
| REF | DN | (g) | S (mm) | L (mm) | T (mm) | H (mm) | W (mm) | ΔP:1bar (m ³ /h) | Group2 fluids |
| REF4.0.022.3.P | 22 | - | - | - | - | - | - | - | Art.3.3 |
| REF4.0.028.1.P | 28 | - | - | - | - | - | - | - | Art.3.3 |
| REF4.0.028.1.P | 1-1/8" | - | - | - | - | - | - | - | Art.3.3 |





THE IMAGE SHOWS: ball-valve design guarantees 4Way Reversing Valves to have minimum pressure drop and very low risk of leakage and ensures quick changeover even without any pressure differential.

 Refrigerera Check Valves can be mounted in every position and offer the best performance with reduced pressure drops. 2-5/8"×3-1/8" valves are made of steel. Valves are fitted with special seals suitable for R744 and are guaranteed for operating pressures up to 52bar.

 Le nostre valvole di ritengo possono essere montate in qualunque posizione e offrono il migliore fattore di flusso con le minime perdite di carico. I diametri da 2-5/8" a 3-1/8" sono realizzati in acciaio. Le valvole sono dotate di guarnizioni speciali idonee per R744 e sono garantite per pressioni di esercizio fino a 52bar.

 Unsere Rückschlagventile können in jeder Stellung montiert werden und bieten bei minimalen Druckverlusten den besten Durchflussfaktor. Die Durchmesser von 2-5/8" bis 3-1/8" sind aus Stahl gefertigt. Die Ventile sind mit speziellen, für R744 geeignete Dichtungen ausgerüstet und werden für einen Betriebsdruck bis 52.

 Nos vannes à clapets peuvent être montées dans toutes les positions et offrir la meilleure performance avec une pression réduite. Les diamètres de 2-5/8" à 3-1/8" sont fabriqués en acier. Les vannes sont équipées de joints spéciaux appropriés pour le gaz R744 et sont garanties pour des pressions jusqu'à 52bar.

 Nuestras válvulas de retención pueden ser montadas en cualquier posición y ofrecen el mejor factor de flujo con la mínimas pérdida de carga. Los diámetros de 2-5/8" a 3-1/8" son realizadas en acero. Las válvulas están dotadas de guarniciones especiales idóneas para R744 y están garantizadas para presiones hasta 52 bar.

 As nossas válvulas de retenção podem ser montadas em qualquer posição e oferecem o melhor fator de vazão com uma queda mínima de pressão. As válvulas com diâmetros de 2-5/8" a 3-1/8" são inteiramente realizadas em aço. As válvulas possuem vedações especiais apropriadas para R744 e são garantidas para pressões de exercício até 52 bar.

 弊社チェック・バルブは、あらゆるポジションでマウントすることができ、減少されたプレッシャー・ドロップで、最高のパフォーマンスを提供することができます。2インチ5/8から3インチ1/8のバルブが、スチールで作られています。バルブは、R744に適した特別なシールによってフィットされ、最大52/バーまでのオペレーション・プレッシャーに対して保証されています。

 Наши обратные клапаны могут монтироваться в любом положении и обеспечивают лучший коэффициент потока при минимальных потерях. Клапаны 2-5/8"×3-1/8" изготавливаются из стали. Клапаны оснащены специальными уплотнениями для R744 и гарантированы в давлениях до 52bar.

subcritical R744 Check Valve

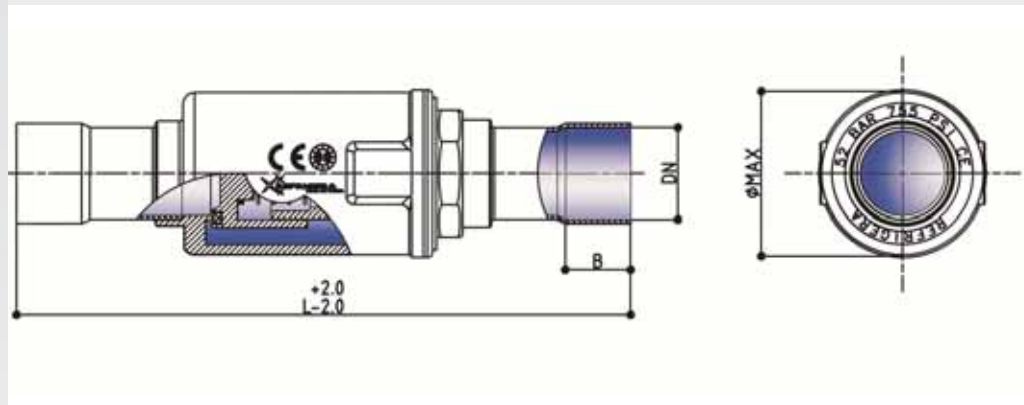



| Code | Connections | Weight | ODS | B | Length | ØMax | P.E.D. |
|-----------------|---------------|--------|------|----|--------|------|---------------|
| REF | DN | (g) | mm | mm | mm | mm | Group2 fluids |
| REF3.1.N.006.52 | 6mm | 95 | 6,1 | 7 | 107 | 24 | Art.3.3 |
| REF3.1.N.014.52 | 1/4" | 95 | 6,4 | 7 | 107 | 24 | Art.3.3 |
| REF3.1.N.008.52 | 8mm (5/16") | 95 | 8,1 | 7 | 112 | 24 | Art.3.3 |
| REF3.1.N.010.52 | 10mm | 96 | 10,2 | 9 | 112 | 24 | Art.3.3 |
| REF3.1.N.038.52 | 3/8" | 96 | 9,7 | 9 | 112 | 24 | Art.3.3 |
| REF3.1.N.012.52 | 12mm | 100 | 12,2 | 12 | 120 | 24 | Art.3.3 |
| REF3.1.N.127.52 | 1/2" | 100 | 12,8 | 12 | 120 | 24 | Art.3.3 |
| REF3.1.N.015.52 | 15mm | 285 | 15,2 | 12 | 152 | 36 | Art.3.3 |
| REF3.1.N.016.52 | 16mm (5/8") | 280 | 16,2 | 14 | 152 | 36 | Art.3.3 |
| REF3.1.N.018.52 | 18mm | 285 | 18,2 | 14 | 152 | 36 | Art.3.3 |
| REF3.1.N.034.52 | 3/4" | 285 | 19,3 | 14 | 152 | 36 | Art.3.3 |
| REF3.1.N.022.52 | 22mm (7/8") | 350 | 22,3 | 17 | 180 | 36 | Art.3.3 |
| REF3.1.N.028.52 | 28mm | 1200 | 28,2 | 20 | 230 | 55 | Art.3.3 |
| REF3.1.N.118.52 | 1-1/8" | 1200 | 28,8 | 20 | 230 | 55 | Art.3.3 |
| REF3.1.N.035.52 | 35mm (1-3/8") | 1560 | 35,2 | 25 | 240 | 66 | Class I |
| REF3.1.N.042.52 | 42mm | 2390 | 42,2 | 28 | 270 | 80 | Class I |
| REF3.1.N.158.52 | 1-5/8" | 2390 | 41,5 | 28 | 270 | 80 | Class I |
| REF3.1.N.054.52 | 54mm (2-1/8") | 3430 | 54,3 | 36 | 295 | 93 | Class I |

W:Reduced Port

N: standard spring valve with minimum Opening Pressure Differential =0,1 bar

R: reinforced spring valve with minimum Opening Pressure Differential =0,3 bar

 Valves are fitted with special seals suitable for R744 and are guaranteed for operating pressures up to 52bar. Bi-flow system allows the NPT Valves suitable to be used together with safety valve of the same Nominal Diameter.

 Le valvole sono dotate di guarnizioni speciali idonee per R744 e sono garantite per pressioni di esercizio fino a 52bar. Le valvole NPT sono adatte per essere utilizzate assieme alle valvole di sicurezza dello stesso diametro nominale.

 Die Ventile sind mit speziellen, für R744 geeignete Dichtungen ausgerüstet und werden für einen Betriebsdruck bis 52 Bar garantiert. Die NPT-Ventile eignen sich für den Einsatz zusammen mit Sicherheitsventilen des gleichen Nenndurchmessers.

 Les vannes sont équipées de joints spéciaux appropriés pour R744 et sont garantis pour des pressions jusqu'à 52bar. Les vannes NPT sont appropriées pour être utilisées avec les soupapes de sûreté du même diamètre nominal.

 Las válvulas están dotadas de guarniciones especiales idóneas para R744 y están garantizadas para presiones hasta 52 bar. Las válvulas NPT están adaptadas para ser utilizadas junto a las válvulas de seguridad del mismo diámetro nominal.

 As válvulas possuem vedações especiais apropriadas para R744 e são garantidas para pressões de exercício até 52 bar. As válvulas NPT são apropriadas para serem utilizadas junto com as válvulas de segurança com o mesmo diâmetro nominal.

 バルブは、R744に適した特別なシールによってフィットされ、最大52バーまでのオペレーション・プレッシャーに対して保証されています。弊社バイ・フロー・システムは、適切なNPTバルブが、同じ名目直径のセーフティー・バルブと一緒に使用されることを、可能にします。

 Клапаны оснащены специальными уплотнениями для R744 и гарантированы в давлениях до 52bar. Клапаны NPT предназначены для использования вместе с предохранительными клапанами с таким же номинальным диаметром.

subcritical R744 NPT Ball Valve

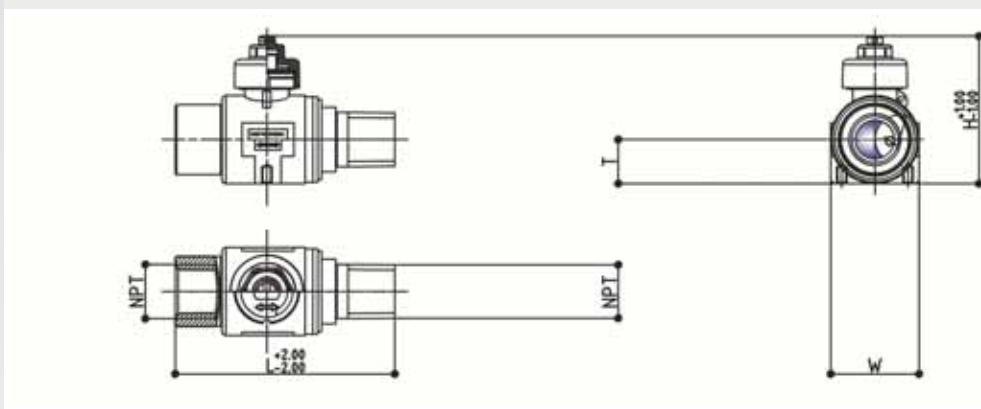



| Code | Connection | Weight | Sphere passage | Length | Height | Wide | V | T | Kv | WTemp | P.E.D. |
|-----------------------|------------|--------|----------------|--------|--------|--------|--------|--------|----------------|-----------|---------------|
| REF | DN | (g) | Ø (mm) | L (mm) | H (mm) | W (mm) | V (mm) | T (mm) | ΔP:1bar (m³/h) | °C | Group2 fluids |
| REF1.1.P.B.012.1.N.52 | 1/2" | 360 | 15 | 85 | 56,5 | 34 | 24 | 17 | 13 | -40/ +150 | Art.3.3 |
| REF1.1.P.C.001.1.N.52 | 1" | 890 | 19 | 120 | 85 | 46 | 35 | 26 | 24 | | Art.3.3 |





THE IMAGE SHOWS: an NPT Valve mounted with a Safety Valve on a Changeover Device.

 The changeover is a service device for safety valves that allows using one valve while isolating the other from the system. The valve ensures a pressure drop compatible with the safety valve operation under condition of discharge of saturated or overheated vapour. Valves are fitted with special seals suitable for R744 and are guaranteed for operating pressures up to 52bar.

 La valvola deviatrice è un rubinetto di servizio tra due valvole di sicurezza che esclude alternativamente l'una o l'altra permettendo interventi sull'impianto. Il rubinetto assicura una caduta di pressione compatibile con il funzionamento dei dispositivi di sicurezza in condizioni di scarico sia di vapore saturo che di vapore surriscaldato. Le valvole sono dotate di guarnizioni speciali idonee per R744 e sono garantite per pressioni di esercizio fino a 52bar.

 Das Umleitventil ist ein Sperrhahn zwischen zwei Sicherheitsventilen, der abwechselnd das eine oder andere ausschließt und damit Eingriffe an der Anlage erlaubt. Der Hahn sichert einen Druckabfall, der mit dem Betrieb der Sicherheitsvorrichtungen sowohl bei Ableitung von gesättigtem als auch von überhitztem Dampf kompatibel ist. Die Ventile sind mit speziellen für R744 geeignete Dichtungen ausgerüstet und werden für einen Betriebsdruck bis 52 Bar garantiert.

 La vanne d'échange sert de robinet de service pour un couple de vannes de sécurité, en permettant l'utilisation de l'une et l'exclusion de l'autre. La vanne assure une chute de pression parfaitement compatible avec le fonctionnement du dispositif de sécurité et des conditions d'évacuation aussi bien de la vapeur saturée que de la vapeur de surchauffe. Les vannes sont équipées de joints spéciaux appropriés pour le gaz R744 et sont garantis pour des pressions jusqu'à 52bar.

 Las válvula de desvío es una llave de paso de servicio entre dos válvulas de seguridad que excluye alternativamente o una o la otra, permitiendo intervenciones en la instalación. Esta llave de paso asegura la caída de presión compatible con el funcionamiento de los dispositivos de seguridad en condiciones de descarga ya sea de vapor saturado que de vapor sobrecalentado. Las válvulas están dotadas de guarniciones especiales idóneas para R744 y están garantizadas para presiones de hasta 52 bar.

 A válvula de desviadora é um registro de serviço entre duas válvulas de segurança que exclui alternadamente uma ou outra, isto para permitir de efetuar operações na instalação. O registro garante uma queda de pressão compatível com o funcionamento dos dispositivos de segurança em condições de descarregar, tanto o vapor saturado como o vapor superaquecido. As válvulas possuem vedações especiais apropriadas para R744 e são garantidas para pressões de exercício até 52 bar.

 チェンジオーバーは、ひとつのバルブを使用しながら、他をシステムからアイソレートすることを可能にする、セーフティー・バルブのためのサービス・デバイスです。同バルブは、サチュレートもしくはオーバーヒートした蒸気のディスチャージ、という条件下でのセーフティー・バルブ・オペレーションと互換性のあるプレッシャー・ドロップを、確保します。バルブは、R744に適した特別なシールによってフィットされ、最大52barまでのオペレーション・プレッシャーに対して保証されています。

 Перекидной клапан - вспомогательный кран между двумя предохранительными клапанами, который поочередно отключает один или другой клапан, позволяя, таким образом, производить вмешательство на установке. Кран обеспечивает падение давления, соответствующее функционированию предохранительных устройств при условиях выпуска, как насыщенного, так и перегретого пара. Клапаны оснащены специальными уплотнениями для R744 и гарантированы в давлениях до 52bar.

subcritical R744 3Way Changeover Valve

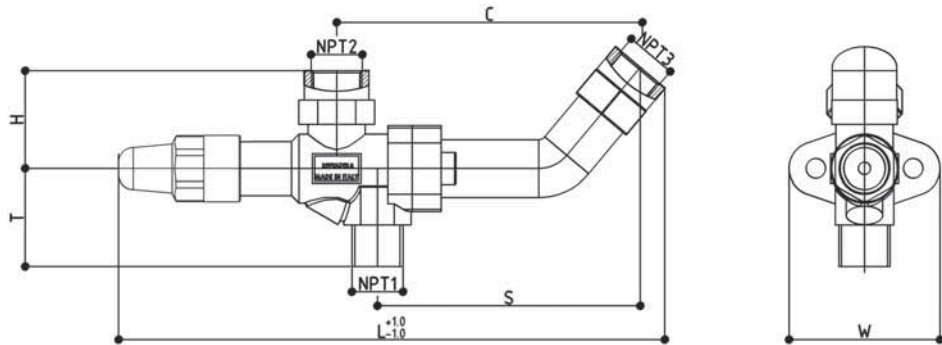
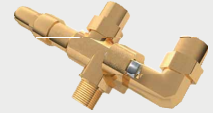



| Code | Connection NPT1 | Conn NPT2 | Conn NPT3 | Length | Height | T | Wide | S | Kv | Wtemp | P.E.D. |
|--------------------|-----------------|-----------|-----------|--------|--------|--------|--------|--------|----------------|-----------|---------------|
| REF | inches | inches | inches | L (mm) | H (mm) | C (mm) | W (mm) | S (mm) | ΔP:1bar (m³/h) | °C | Group2 fluids |
| REF2.1.012.012.012 | 1/2" | 1/2" | 1/2" | 164 | 85 | 70 | 62 | 53,5 | 1,0 | | Art.3.3 |
| REF2.1.012.034.012 | 1/2" | 3/4" | 1/2" | 220 | 90 | 91 | 80 | 66,5 | 1,0 | | Art.3.3 |
| REF2.1.034.034.034 | 3/4" | 3/4" | 3/4" | 220 | 90 | 91 | 80 | 66,5 | 1,0 | -40/ +150 | Art.3.3 |
| REF2.1.100.100.100 | 1" | 1" | 1" | 290 | 124 | 110 | 100 | 72,5 | 2,4 | | Art.3.3 |
| REF2.1.100.114.100 | 1" | 1-1/4" | 1" | 290 | 124 | 110 | 100 | 72,5 | 2,4 | | Art.3.3 |





THE IMAGE SHOWS: a R744 Changeover Device

 Completely made of steel, REFRIGERA driers have the peculiar value to be provided with a spherical shaped molecular sieve, so moisture and acids are absorbed as much as its volume homogeneously. However, in cartridge shape filters, particles are held on the surface and so it becomes useless in short period. We guarantee higher acid and water absorption than silica-gel and activated alumina and absorption of dirt particles more than size of 10 microns by the filtration grade, keeping however a minimum flow resistance.

 I filtri in acciaio REFRIGERA possiedono la peculiarità della costruzione a sfere dei setacci molecolari, ciò mette a contatto il fluido refrigerante con la massima superficie filtrante possibile per garantire un assorbimento omogeneo delle sostanze acide e una maggior durata rispetto ai filtri a cartuccia solida. Rispetto al gel di silice e all'allumina attiva, inoltre, i setacci molecolari posseggono una maggiore capacità di assorbimento dell'acqua pur garantendo minori perdite di carico. Viene garantito il filtraggio completo di particelle sino a 10 micron.

 Die Stahlfilter REFRIGERA haben das besondere Merkmal der Bauweise der Molekularsiebe in Kugelform, die Kältemittelflüssigkeit kommt mit der maximal möglichen Filterfläche in Berührung, um die homogene Absorbierung der Säurelösungen und eine längere Haltbarkeit als die der Patronenfilter zu gewährleisten. Im Vergleich zu Siliziumoxidgel und aktivem Aluminiumoxid besitzen die Molekularsiebe eine größere wasserabsorbierende Kapazität, wobei minimale Druckverluste gewährleistet sind. Die Filterung von Partikeln bis zu 10 Mikron wird garantiert.

 Entièrement en acier, les filtres RÉFRIGÉRA ont l'avantage d'être munis d'un tamis moléculaire en forme sphérique, afin qu'un maximum de fluide frigorigène soit en contact avec la plus grande surface de filtration possible et assurer une absorption uniforme des résiduels d'acide et la plus longue durée de la cartouche du filtre. Par rapport à un gel de silice et d'alumine active, les tamis moléculaires possèdent, en outre, une plus grande capacité à absorber l'eau tout en maintenant une faible perte de charge. Ils garantissent un filtrage de particules jusque 10 microns.

 Los filtros de acero REFRIGERA poseen la particularidad de estar contruidos como los cedazos moleculares a esfera, es decir ponen en contacto el fluido refrigerante con la máxima superficie filtrante posible para garantizar una absorción homogénea de ácidos y una mayor duración con respecto a los filtros de cartuchos sólidos. En lo que respecta al gel de silicio y el aluminio activo, además, los cedazos moleculares poseen una mayor capacidad de absorción de agua garantizando la filtración completa de las partículas hasta 10 micrones.

 Os filtros de aço REFRIGERA apresentam uma característica peculiar na produção de peneiras moleculares com esferas logo, permite colocar o fluido refrigerante em contato com a máxima superfície filtrante possível para garantir a absorção homogênea das salmouras ácidas e maior duração em relação aos filtros de cartucho sólidos. Com relação ao gel de sílica e alumina ativa, as peneiras moleculares possuem uma capacidade maior de absorção da água mesmo garantindo uma queda de pressão menor. Garantem a filtrção completa de partículas até 10 microns.

 レフリジェラ・ドライヤーは、完全にスチールによって作られており、提供されるべき、優れた価値を保持しています。これらは、スフィア形状のモレキュラー・シーブを伴うため、湿度と酸が、そのポリュームまで、同量に吸収されます。しかしながら、カートリッジ・シェイプのフィルターのなかで、パーティクルが表面上に帯びるため、よってこれは短い期間で、使用できなくなります。最小のフロー・レジスタンスを維持しつつ、弊社は、シリカ・ゲルと活性アルミナよりも高い、酸および水の吸収、および、フィルタレーション・グレードで10マイクロンのサイズ以上の、汚れパーティクルの濾過を保証します。

 Стальные фильтры REFRIGERA обладают особенностью шаровой конструкции молекулярных сит. Это обеспечивает контакт охлаждающей жидкости с максимально возможной фильтрующей поверхностью, чтобы гарантировать однородное поглощение кислот растворов и более длительный срок службы по сравнению с фильтрами с твердым патроном. По сравнению с силикагелем и активным оксидом алюминия, молекулярные сита обладают наибольшей возможностью поглощения воды, гарантируя при этом меньшие потери давления. Гарантируется полная фильтрация частиц до 10 микрон.

subcritical R744 Filter Drier

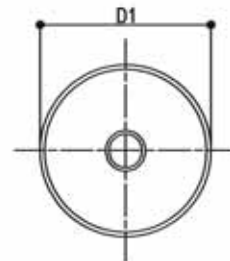
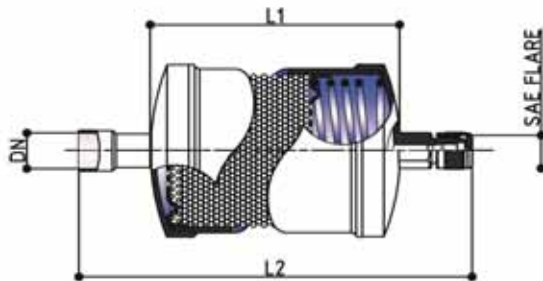



| Code | ODS Con. | SAE Con. | Length | Refrigeration Capacity (kW) DP 0,06 Bar | Body Length | Diam. | Volume | WTemp | P.E.D. |
|------------------|----------|----------|---------|---|-------------|---------|--------------------|-----------|---------------|
| REF | DN | SAE | L2 (mm) | R744 | L1 (mm) | D1 (mm) | (cm ³) | °C | Group2 Fluids |
| REF73.052.02.014 | - | 1/4" | 102 | 4 | 62 | 48 | 83 | | Art.3.3 |
| REF73.082.02.014 | - | 1/4" | 136 | 15 | 86 | 63 | 210 | | Art.3.3 |
| REF73.083.02.038 | - | 3/8" | 143 | 22 | 93 | 63 | 230 | -40/ +120 | Art.3.3 |
| REF73.163.02.038 | - | 3/8" | 161 | 18 | 106 | 63 | 265 | | Art.3.3 |





THE IMAGE SHOWS: New HP filter driers.
Nominal pressure 60 bar - max op. temp 75 °C

 Forged valves provided by inox butt -fusion joining tubes. Valves are guaranteed up to 120 bar nominal pressure.

 Fornite di tronchetti in acciaio inox da saldare testa a testa, le valvole vengono garantite per una PN sino a 120 bar.

 Sie werden mit Edelstahlstutzen geliefert, die stumpf zu schweißen sind, die Ventile sind für einen Nenndruck bis 120 Bar garantiert .

 Fourniture de connexions en inox pour souder bout à bout des tubes, les vannes à boisseaux, garantis jusqu'à la pression nominale du 120 bar.

 Provistas de pequeños troncos en acero inox a soldarse cabeza a cabeza, las válvulas vienen garantizadas para una PN de hasta 120 bar .

 Fornecidas com soquetes de aço inoxidável para soldaduras topo a topo, as válvulas são garantidas para uma PN até 120 bar.

 バット・フュージョンInox結合チューブによって提供されるフォージ・バルブ。バルブは、最大120バーのプレッシャーまで、最低限保証されています。

 Оснащены патрубками из нержавеющей стали для стыкового сваривания, клапаны гарантируются для НД до 120 бар.

transcritical R744 Ball Valve

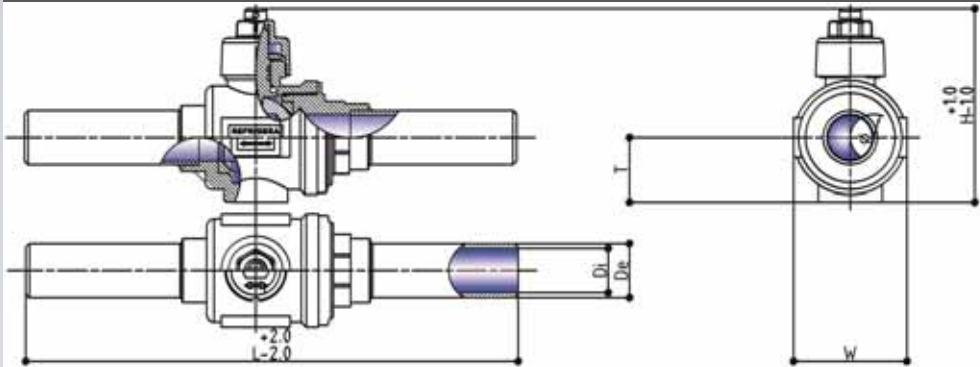



| Code | Connections Size According to ASME/ANSI B36.10 | Weight | Buttwelding Steel Tube Ø | Lenght | Height | Height | Wide | Kv | WTemp | P.E.D. | |
|-----------------------|---|--------|-----------------------------|-------------|-----------|-----------|-----------|-----------|-------------------|-----------|------------------|
| REF | DN | (g) | Ø e (mm) | Ø i (mm) | L (mm) | T (mm) | H (mm) | W (mm) | ΔP:1bar (m³/h) | °C | Group2 fluids |
| REF1.1.N.A.006.1.120* | | 108 | - | 6,2 | 99 | 13 | 41 | 24 | 1 | -40/ +150 | Art.3.3 |
| REF1.1.N.A.008.1.120 | | 108 | 8 | 5 | 104 | 13 | 41 | 24 | 2,7 | | Art.3.3 |
| REF1.1.N.A.010.1.120 | | 110 | 10 | 8 | 104 | 13 | 41 | 24 | 2,7 | | Art.3.3 |
| REF1.1.N.A.012.1.120 | | 90 | 12 | 10 | 112 | 13 | 41 | 24 | 2,7 | | Art.3.3 |
| REF1.1.N.B.016.3.120 | | 340 | 16 | 14 | 145 | 17 | 58 | 34 | 13 | | Art.3.3 |
| REF1.1.N.B.018.1.120 | | 360 | 18 | 16 | 145 | 17 | 58 | 34 | 14 | | Art.3.3 |
| REF1.1.N.C.022.3.120 | | 760 | 22 | 18 | 200 | 28 | 80 | 46 | 24 | | Art.3.3 |
| REF1.1.N.D.028.1.120 | | 810 | 28 | 24 | 185 | 28 | 85 | 51 | 40 | | Art.3.3 |
| REF1.1.N.E.032.3.120 | | 1600 | 35 | 31 | 205 | 35 | 104 | 66 | 67,3 | | Art.3.3 |
| REF1.1.N.F.042.1.120 | 32 | 2950 | 42 | 35 | 240 | 48 | 120 | 77 | 76,8 | | Art.3.3 |
| REF1.1.S.A.006.1.120* | | 290 | - | 6,2 | 126 | 15 | 55 | 33 | 1 | | Art.3.3 |
| REF1.1.S.A.008.1.120 | | 285 | 8 | 5 | 132 | 15 | 54 | 33 | 1 | | Art.3.3 |
| REF1.1.S.A.010.1.120 | | 285 | 10 | 8 | 132 | 15 | 54 | 33 | 2,7 | | Art.3.3 |
| REF1.1.S.A.012.1.120 | | 285 | 12 | 10 | 140 | 15 | 55 | 33 | 2,7 | | Art.3.3 |
| REF1.1.S.B.016.3.120 | | 385 | 16 | 14 | 153 | 17 | 58 | 34 | 13 | | Art.3.3 |
| REF1.1.S.B.018.1.120 | | 390 | 18 | 16 | 153 | 17 | 59 | 34 | 14 | | Art.3.3 |

* Cu-DHP Connections





THE IMAGE SHOWS: a high pressure Forged Brass Ball Valve

 Forged valves provided by inox butt -fusion joining tubes. Valves are guaranteed up to 120 bar nominal pressure.

 Fornite di tronchetti in acciaio inox da saldare testa a testa, le valvole vengono garantite per una PN sino a 120 bar.

 Sie werden mit Edelstahlstutzen geliefert, die stumpf zu schweißen sind, die Ventile sind für einen Nenndruck bis 120 Bar garantiert .

 Fourniture de connexions en inox pour souder bout à bout des tubes, les vannes à boisseaux, garantis jusqu'à la pression nominale du 120 bar .

 Provistas de pequeños troncos en acero inox a soldarse cabeza a cabeza, las válvulas vienen garantizadas para una PN de hasta 120 bar.

 Fornecidas com soquetes de aço inoxidável para soldaduras topo a topo, as válvulas são garantidas para uma PN até 120 bar.

 バット・フュージョンInox結合チューブによって提供されるフォージ・バルブ。バルブは、最大120バーのプレッシャーまで、最低限保証されています。

 Клапаны, оснащены патрубками из нержавеющей стали для стыкового сваривания, гарантируются для НД до 120 бар.

transcritical R744 3Way Ball Valve

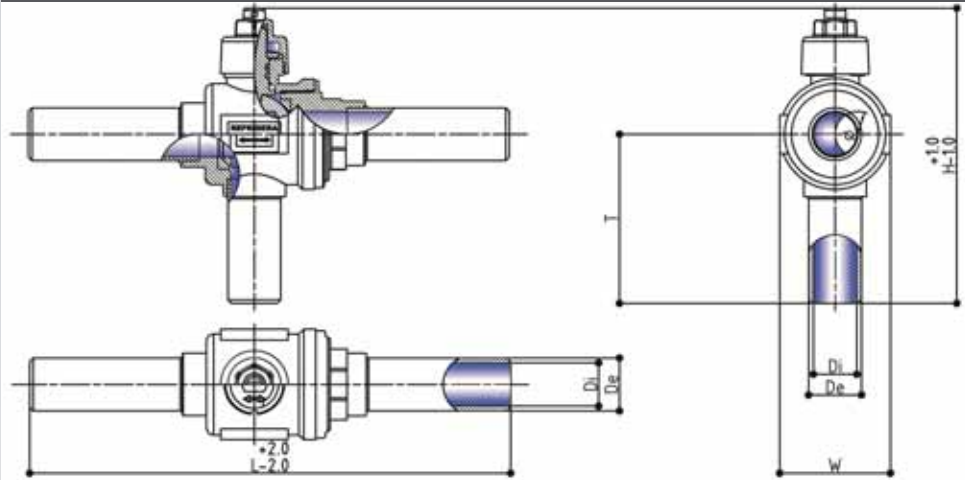



| Code | Connections Size According to ASME/ANSI B36.10 | Weight | Buttwelding Steel Tube Ø | | Length | Height | Height | Wide | Kv | WTemp | P.E.D. |
|------------------------|--|--------|-----------------------------|-------------|-----------|-----------|-----------|-----------|-------------------|-----------|------------------|
| REF | DN | (g) | Ø e (mm) | Ø i (mm) | L (mm) | T (mm) | H (mm) | W (mm) | ΔP:1bar (m³/h) | °C | Group2 fluids |
| REF1.1.S.A.006.1.M120* | | 280 | - | 6,2 | 132 | 48 | 87 | 33 | 0,8 | | Art.3.3 |
| REF1.1.S.A.008.1.M120 | | 280 | 8 | 5 | 132 | 48 | 87 | 33 | 0,8 | | Art.3.3 |
| REF1.1.S.A.010.1.M120 | | 280 | 10 | 8 | 132 | 48 | 87 | 33 | 0,8 | | Art.3.3 |
| REF1.1.S.A.012.1.M120 | | 280 | 12 | 10 | 140 | 53 | 92 | 33 | 2,7 | | Art.3.3 |
| REF1.1.S.B.016.3.M120 | | 400 | 16 | 14 | 153 | 62 | 104 | 34 | 5,6 | | Art.3.3 |
| REF1.1.S.B.018.1.M120 | | 400 | 18 | 16 | 153 | 62 | 104 | 34 | 5,8 | | Art.3.3 |
| REF1.1.N.B.016.3.M120 | | 350 | 16 | 14 | 145 | 62 | 104 | 34 | 5,6 | -40/ +150 | Art.3.3 |
| REF1.1.N.B.018.1.M120 | | 360 | 18 | 16 | 145 | 62 | 104 | 34 | 5,8 | | Art.3.3 |
| REF1.1.N.C.022.3.M120 | | 780 | 22 | 18 | 200 | 90 | 145 | 46 | 10,3 | | Art.3.3 |
| REF1.1.N.D.028.1.M120 | | 820 | 28 | 24 | 190 | 92 | 147 | 51 | 15,5 | | Art.3.3 |
| REF1.1.N.E.032.3.M120 | | 1600 | 35 | 31 | 200 | 94 | 162 | 64 | 19,7 | | Art.3.3 |
| REF1.1.N.F.042.1.M120 | 32 | 2900 | 42 | 35 | 240 | 113 | 190 | 76 | 39,5 | | Art.3.3 |

* Cu-DHP Connections





THE IMAGE SHOWS: a high pressure three Way Ball Valve

 Forged valves provided by inox butt -fusion joining tubes. Valves are guaranteed up to 120 bar nominal pressure.

 Fornite di tronchetti in acciaio inox da saldare testa a testa, le valvole vengono garantite per una PN sino a 120 bar.

 Sie werden mit Edelstahlstutzen geliefert, die stumpf zu schweißen sind, die Ventile sind für einen Nenndruck bis 120 Bar garantiert.

 Fourniture de connections en inox pour souder bout à bout des tubes, les vannes à boisseaux, garantis jusqu'à la pression nominale du 120 bar.

 Provistas de pequeños troncos en acero inox a soldarse cabeza a cabeza, las válvulas vienen garantizadas para una PN de hasta 120 bar.

 Fornecidas com soquetes de aço inoxidável para soldaduras topo a topo, as válvulas são garantidas para uma PN até 120 bar.

 バット・フュージョンInox結合チューブによって提供されるフォージ・バルブ。バルブは、最大120バーのプレッシャーまで、最低限保証されています。

 Клапаны, оснащены патрубками из нержавеющей стали для стыкового сваривания, гарантируются для НД до 120 бар.

transcritical R744 4Way Ball Valve

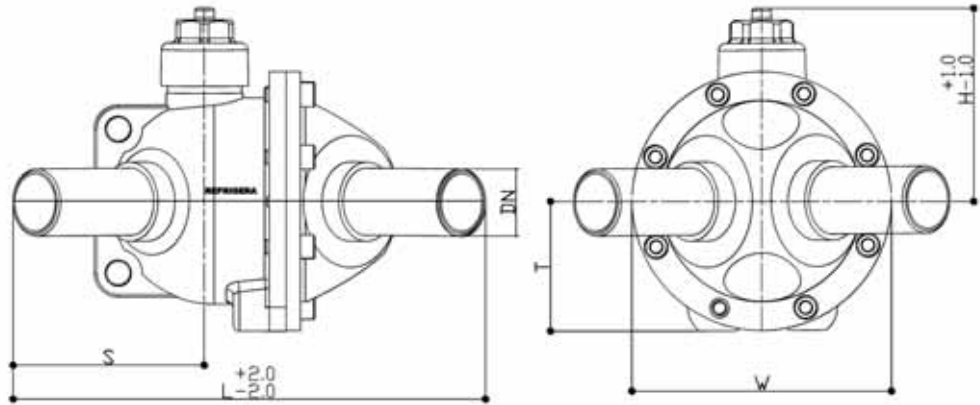
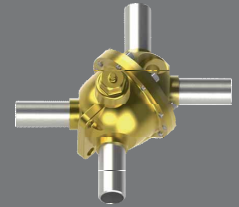



| Code | Weight | Buttwelding Steel Tube Ø | | Length | Height | Height | Wide | Kv | P.E.D. |
|------------------|--------|--------------------------|----------|--------|--------|--------|--------|----------------|---------------|
| | | Ø e (mm) | Ø i (mm) | | | | | | |
| REF | (g) | | | L (mm) | T (mm) | H (mm) | W (mm) | ΔP:1bar (m³/h) | Group2 fluids |
| REF4.1.028.1.120 | - | - | - | - | - | - | - | 12,5 | Art.3.3 |





THE IMAGE SHOWS: 4-way Valves mounting **AISI304** connections, suitable to be installed in **R744** trans-critical systems

 The DIN ISO-5211 standard flange, allows to fit valves with all the actuators on the market, when it is necessary the remote control of opening and closing or adjusting the direction of flow. The lever shaft is mounted in explosion-proof configuration and is hermetic airtight designed.

 La flangia ISO-DIN 5211 standard permette l'accoppiamento delle valvole con tutti gli attuatori attualmente presenti sul mercato per tutti i casi in cui sia necessario il controllo a distanza dell'apertura e chiusura o regolare la direzione del flusso. Il perno di manovra viene montato in configurazione antisceppio ed è progettato a tenuta ermetica.

 Der Standardflansch ISO-DIN 5211 ermöglicht in allen Fällen, in denen die Fernsteuerung der Öffnung und Schließung oder die Durchflussrichtung zu regeln ist, den Anschluss der Ventile an alle momentan auf dem Markt befindlichen Antriebe. Der Schaltzapfen wird mit einer Berstsicherung montiert und verfügt über eine hermetische Dichtung.

 La bride ISO-DIN 5211 standard permet de créer la paire de vannes pour tous les acteurs sur le marché aujourd'hui, pour tous les cas où il est nécessaire d'utiliser la télécommande d'ouverture et de fermeture ou de réglage de la direction du flux. Le levier est monté dans une configuration anti explosion, conçu hermétiquement avec le joint O-Ring R744, compatible pour le R744.

 La brida ISO-DIN 5211 estándar permite acopiar las válvulas con todos los actuadores presentes en el mercado en los cuales sea necesario el control a distancia de la apertura y cierre o para regular la dirección del flujo. El perno de maniobra viene montado con configuración antideflagrante y fijado hermético.

 O flange padrão ISO-DIN 5211, permite o acoplamento das válvulas com todos os atuadores atualmente disponíveis no comércio para todos os casos em que for necessário controlar à distância, tanto a abertura como o fechamento ou então regular a direção do fluxo. O pivô é montado na configuração à prova de explosão e lacrado hermeticamente.

 DIN ISO-5211

水準の同フランジは、市場に存在するすべてのアクチュエーターにバルブをフィットさせることを可能とします。これは、開口と閉口、あるいはフローの方向調節をリモート・コントロールする際に必要となります。レバー・シャフトが、爆発防止の設定でマウントされており、完封エアタイト設計されています。

 Стандартный фланец DIN ISO-5211 позволяет соединению клапанов со всеми приводами рынка. Полезно в тех случаях, когда нужно удаленного контроля или регулирования открытия и закрытия потока. Рычаг вала осуществляет взрывобезопасную функцию и герметично запечатан.

transcritical R744 Ball Valve fit for Actuator

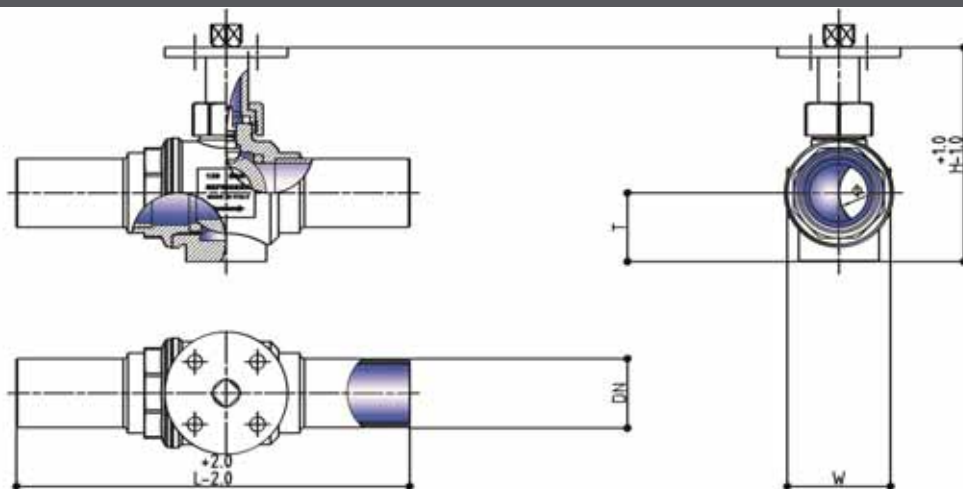

| Code | Connection | Weight | Sphere passage | Length | Height | Wide | S | T | Kv | WTemp | P.E.D. |
|------------------------|------------|--------|----------------|--------|--------|--------|--------|--------|----------------|-----------|---------------|
| REF | DN | (g) | Ø (mm) | L (mm) | H (mm) | W (mm) | S (mm) | T (mm) | ΔP:1bar (m³/h) | °C | Group2 fluids |
| REF1.1.S.A.008.1.120.P | | 108 | 10 | 132 | 107 | 22 | 63 | 15 | 1 | | Art.3.3 |
| REF1.1.S.A.010.1.120.P | | 108 | 10 | 132 | 107 | 22 | 63 | 15 | 2,7 | | Art.3.3 |
| REF1.1.S.A.012.1.120.P | | 120 | 10 | 139 | 107 | 22 | 67 | 15 | 2,7 | | Art.3.3 |
| REF1.1.N.B.016.3.120.P | | 360 | 15 | 148 | 78 | 34 | 68 | 17 | 13 | | Art.3.3 |
| REF1.1.S.B.016.3.120.P | | 390 | 15 | 153 | 78 | 34 | 68 | 17 | 13 | | Art.3.3 |
| REF1.1.N.B.018.1.120.P | | 360 | 15 | 148 | 78 | 34 | 68 | 17 | 14 | | Art.3.3 |
| REF1.1.S.B.018.1.120.P | | 390 | 15 | 153 | 78 | 34 | 68 | 17 | 14 | -20/ +100 | Art.3.3 |
| REF1.1.N.C.022.3.120.P | | 750 | 19 | 185 | 92 | 46 | 85 | 26 | 24 | | Art.3.3 |
| REF1.1.N.D.028.1.120.P | | 1076 | 25 | 185 | 98 | 52 | 90 | 28 | 40 | | Art.3.3 |
| REF1.1.N.E.032.3.120.P | | 1322 | 32 | 205 | 110 | 66 | 95 | 31 | 67,3 | | Art.3.3 |
| REF1.1.N.F.042.1.120.P | 32 | 2400 | 40 | 240 | 110 | 76 | 115 | 48 | 76,8 | | Art.3.3 |

*CONNECTION KIT ARE SOLD SEPARATELY. PLS REFER TO CONNECTION KIT PAGE



THE IMAGE SHOWS: a high pressure Ball Valve mounting rotary electrical actuator

 The DIN ISO-5211 standard flange, allows to fit valves with all the actuators on the market, when it is necessary the remote control of opening and closing or adjusting the direction of flow.

The lever shaft is mounted in explosion-proof configuration and is hermetic airtight designed.

 La flangia ISO-DIN 5211 standard permette l'accoppiamento delle valvole con tutti gli attuatori attualmente presenti sul mercato per tutti i casi in cui sia necessario il controllo a distanza dell'apertura e chiusura o regolare la direzione del flusso.

Il perno di manovra viene montato in configurazione antiscoppio ed è progettato a tenuta ermetica.

 Der Standardflansch ISO-DIN 5211 ermöglicht in allen Fällen, in denen die Fernsteuerung der Öffnung und Schließung oder die Durchflussrichtung zu regeln ist, den Anschluss der Ventile an alle momentan auf dem Markt befindlichen Antriebe Der Schaltzapfen wird mit einer Berstsicherung montiert und verfügt über eine hermetische Dichtung.

 La bride ISO-DIN 5211 standard permet de créer la paire de vannes pour tous les acteurs sur le marché aujourd'hui, pour tous les cas où il est nécessaire d'utiliser la télécommande d'ouverture et de fermeture ou de réglage de la direction du flux.

Le levier est monté dans une configuration anti explosion, conçu hermétiquement avec le joint O-Ring R744, compatible pour le R744.

 La brida ISO-DIN 5211 estándar permite acopiar las válvulas con todos los actuadores presentes en el mercado en los cuales sea necesario el control a distancia de la apertura y cierre o para regular la dirección del flujo. El perno de maniobra viene montado con configuración antideflagrante y fijado hermético.

 O flange padrão ISO-DIN 5211, permite o acoplamento das válvulas com todos os atuadores atualmente disponíveis no comércio para todos os casos em que for necessário controlar à distância, tanto a abertura como o fechamento ou então regular a direção do fluxo. O pivô é montado na configuração à prova de explosão e lacrado hermeticamente.

 DIN ISO-5211 水準の同フランジは、市場に存在するすべてのアクチュエーターにバルブをフィットさせることを可能とします。これは、開口と閉口、あるいはフローの方向調節をリモート・コントロールする際に必要となります。レバー・シャフトが、爆発防止の設定でマウントされており、完封エアタイト設計されています。

 Стандартный фланец DIN ISO-5211 позволяет соединению клапанов со всеми приводами рынка. Полезно в тех случаях, когда нужно удаленного контроля или регулирования открытия и закрытия потока. Рычаг вала осуществляет взрывобезопасную функцию и герметично запечатан.

transcritical R744 3Way B.V. fit for Actuator

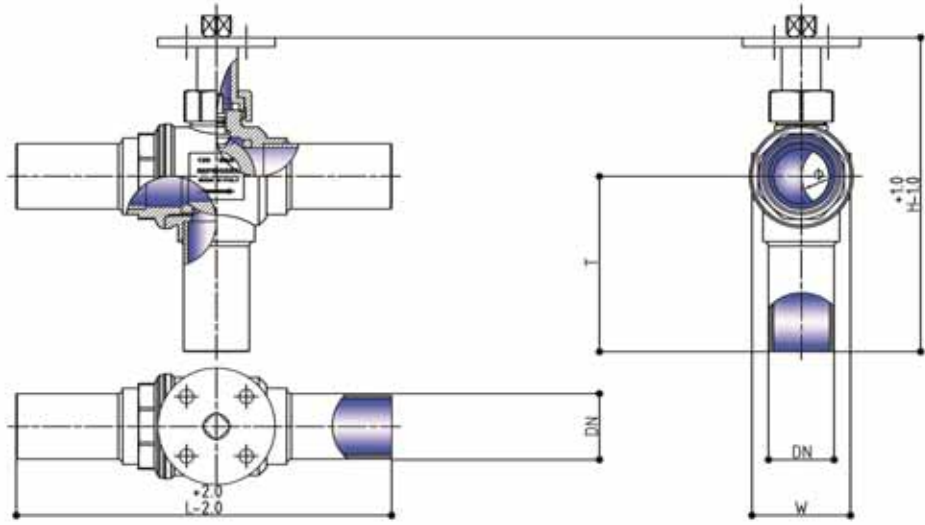



| Code | Connection | Weight | Sphere passage | Length | Height | Wide | S | T | Kv | WTemp | P.E.D. |
|------------------------|------------|--------|----------------|--------|--------|--------|--------|--------|----------------|-----------|---------------|
| REF | DN | (g) | Ø(mm) | L (mm) | H (mm) | W (mm) | S (mm) | T (mm) | ΔP:1bar (m³/h) | °C | Group2 fluids |
| REF1.1.S.A.008.1.MP120 | | 108 | 10 | 132 | 107 | 22 | 63 | 48 | 0,8 | | Art.3.3 |
| REF1.1.S.A.010.1.MP120 | | 108 | 10 | 132 | 107 | 22 | 63 | 48 | 0,8 | | Art.3.3 |
| REF1.1.S.A.012.1.MP120 | | 120 | 10 | 139 | 107 | 22 | 67 | 53 | 2,7 | | Art.3.3 |
| REF1.1.N.B.016.3.MP120 | | 360 | 15 | 148 | 78 | 34 | 68 | 62 | 5,6 | | Art.3.3 |
| REF1.1.S.B.016.3.MP120 | | 390 | 15 | 153 | 78 | 34 | 68 | 62 | 5,6 | | Art.3.3 |
| REF1.1.N.B.018.1.MP120 | | 360 | 15 | 148 | 78 | 34 | 68 | 62 | 5,8 | | Art.3.3 |
| REF1.1.S.B.018.1.MP120 | | 390 | 15 | 153 | 78 | 34 | 68 | 62 | 5,8 | -20/ +100 | Art.3.3 |
| REF1.1.N.C.022.3.MP120 | | 750 | 19 | 185 | 92 | 46 | 85 | 80 | 10,3 | | Art.3.3 |
| REF1.1.N.D.028.1.MP120 | | 1076 | 25 | 185 | 98 | 52 | 90 | 90 | 15,5 | | Art.3.3 |
| REF1.1.N.E.032.3.MP120 | | 1322 | 32 | 205 | 110 | 66 | 95 | 94 | 19,7 | | Art.3.3 |
| REF1.1.N.F.042.1.MP120 | 32 | 2400 | 40 | 240 | 110 | 76 | 115 | 113 | 39,5 | | Art.3.3 |

*CONNECTION KIT ARE SOLD SEPARATELY: PLS REFER TO CONNECTION KIT PAGE





THE IMAGE SHOWS: a high pressure three Way Ball Valve mounting rotary electrical actuator

 The DIN ISO-5211 standard flange, allows to fit valves with all the actuators on the market, when it is necessary the remote control of opening and closing or adjusting the direction of flow. The lever shaft is mounted in explosion-proof configuration and is hermetic airtight designed.

 La flangia ISO-DIN 5211 standard permette l'accoppiamento delle valvole con tutti gli attuatori attualmente presenti sul mercato per tutti i casi in cui sia necessario il controllo a distanza dell'apertura e chiusura o regolare la direzione del flusso. Il perno di manovra viene montato in configurazione antiscoppio ed è progettato a tenuta ermetica.

 Der Standardflansch ISO-DIN 5211 ermöglicht in allen Fällen, in denen die Fernsteuerung der Öffnung und Schließung oder die Durchflussrichtung zu regeln ist, den Anschluss der Ventile an alle momentan auf dem Markt befindlichen Antriebe. Der Schaltzapfen wird mit einer Berstsicherung montiert und verfügt über eine hermetische Dichtung.

 La bride ISO-DIN 5211 standard permet de créer la paire de vannes pour tous les acteurs sur le marché aujourd'hui, pour tous les cas où il est nécessaire d'utiliser la télécommande d'ouverture et de fermeture ou de réglage de la direction du flux. Le levier est monté dans une configuration anti explosion, conçu hermétiquement avec le joint O-Ring.

 La brida ISO-DIN 5211 estándar permite acopiar las válvulas con todos los actuadores presentes en el mercado en los cuales sea necesario el control a distancia de la apertura y cierre o para regular la dirección del flujo. El perno de maniobra viene montado con configuración antideflagrante y fijado hermético.

 O flange padrão ISO-DIN 5211, permite o acoplamento das válvulas com todos os atuadores atualmente disponíveis no comércio para todos os casos em que for necessário controlar à distância, tanto a abertura como o fechamento ou então regular a direção do fluxo. O pivô é montado na configuração à prova de explosão e lacrado hermeticamente.

 DIN ISO-5211水準の同フランジは、市場に存在するすべてのアクチュエーターにバルブをフィットさせることを可能とします。これは、開口と閉口、あるいはフローの方向調節をリモート・コントロールする際に必要となります。レバー・シャフトが、爆発防止の設定でマウントされており、完封エアタイト設計されています。

 Стандартный фланец DIN ISO-5211 позволяет соединению клапанов со всеми приводами рынка. Полезно в тех случаях, когда нужно удаленного контроля или регулирования открытия и закрытия потока. Рычаг вала осуществляет взрывобезопасную функцию и он герметично запечатан.

transcritical R744 4Way B.V. fit for Actuator

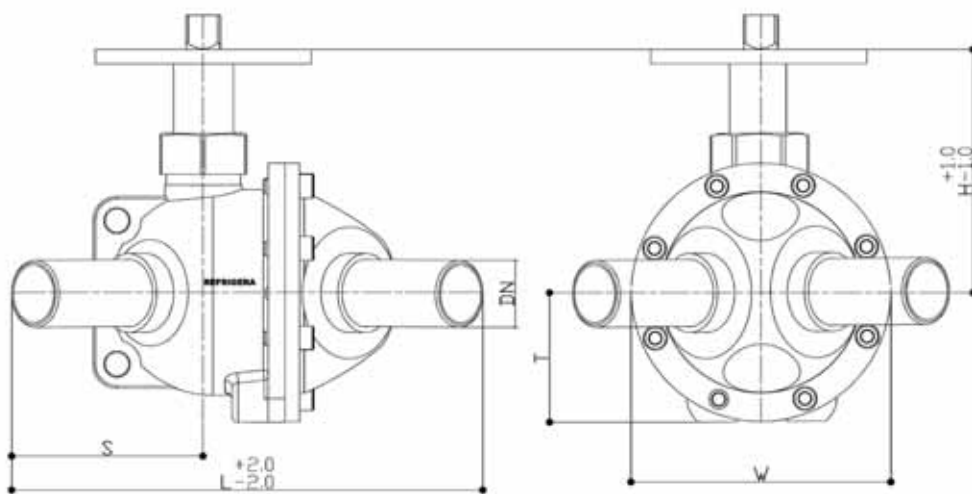
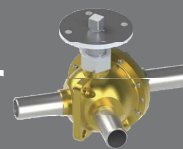



| Code | Weight | Lenght | Lenght | Height | Height | Wide | Kvs | P.E.D. |
|-------------------|--------|--------|--------|--------|--------|--------|----------------|---------------|
| REF | (g) | S (mm) | L (mm) | T (mm) | H (mm) | W (mm) | ΔP:1bar (m³/h) | Group2 fluids |
| REF4.1.028.1.120P | - | - | - | - | - | - | 12,5 | Art.3.3 |





THE IMAGE SHOWS: ISO5211 Flanged 4 Way Reversing Valve for high pressure HVAC systems, purposely burst-proof designed for heavy duty HVAC applications, allows easy coupling to every electrical actuator model on the market.

 Our bi-flow system allows the mounting of the valve without taking into consideration the direction of the flow. The small equalization hole on the sphere will allow the valve to support the gas pressure without stressing other components. Special executions: flare-flare or sweat-flare valves are available.

 Il brevettato sistema bidirezionale permette di montare la valvola indipendentemente dalla direzione del flusso. Il piccolo foro sulla sfera fa sì che la valvola possa sopportare la pressione del gas senza sollecitare i seggi di tenuta. Si eseguono valvole in esecuzioni speciali filettate-filettate oppure filettate-a saldare.

 Das patentierte Zweigewegsystem ermöglicht die Montage des Ventils unabhängig von der Strömungsrichtung. Die kleine Bohrung auf der Kugel sorgt dafür, dass das Ventil den Gasdruck aushält ohne die Dichtungssitze zu belasten. Gefertigt werden Ventile in Sonderanfertigungen, wie gebördelt oder gebördelt zum Lötten.

 Notre système bi-directionnel permet d'installer la vanne sans se préoccuper de la direction du flux. Le petit trou permet à la vanne de supporter la pression du gaz utilisé sans trop solliciter les autres composants. Exécutions spéciales flare ou sweat-flare disponibles.

 El sistema bidireccional patentado permite montar la válvula independientemente de la dirección del flujo. El pequeño orificio sobre la esfera hace que la válvula pueda soportar la presión del gas sin presionar los asientos de contención.

 O sistema bidireccional patentado permite de montar a válvula independentemente da direção do fluxo. O pequeno orificio sobre a esfera faz com a válvula possa suportar a pressão do gás sem forçar as sedes de vedação. Produzimos válvulas com funcionamentos especiais tais como, de rosca-rosqueadas ou de rosca-para solda.

 弊社バイ・フロー・システムはフローの方向を考慮に入れないバルブのマウンティングを可能とします。スフィア上の小さいイコライゼーション・ホールにより、バルブは、他のコンポーネントをストレスさせずにガス・プレッシャーをサポートすることが可能です。特別生産:フレア・フレア、もしくはスウェット・フレア・バルブが入手可能です。

 Наша двунаправленная система позволяет монтировать клапан без учёта направления потока. Небольшое отверстие на шаре позволяет клапану выдерживать давление газа без нагрузки на остальной материал. Имеются винтовые клапаны и пайка-винтовые клапаны.

transcritical R744 DN-NPT Ball Valve

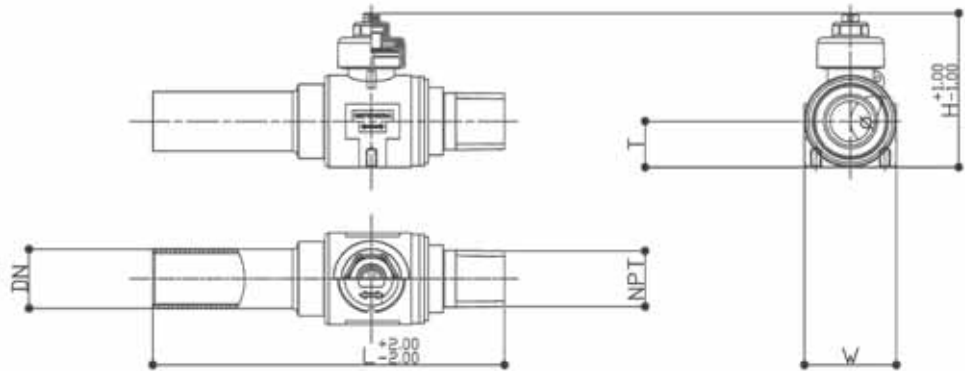
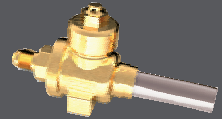



| Code | Weight | Sphere passage | Length | Height | Wide | IN | Kv | WTemp | P.E.D. |
|----------------------|--------|----------------|--------|--------|--------|------|-----------------------------|-----------|---------------|
| REF | (g) | Ø (mm) | L (mm) | H (mm) | W (mm) | NPT | ΔP:1bar (m ³ /h) | °C | Group2 fluids |
| REF1.1.N.P12.016.120 | 290 | 15 | 115 | 56 | 33 | 1/2" | 13 | | Art.3.3 |
| REF1.1.N.P12.018.120 | 290 | 15 | 115 | 56 | 33 | 1/2" | 13 | -40/ +150 | Art.3.3 |
| REF1.1.N.P01.022.120 | 360 | 19 | 155 | 83 | 45 | 1" | 24 | | Art.3.3 |





THE IMAGE SHOWS: H.P. DN / NPT ball valve useful to be easy and safe coupled with receivers through NPT connection

 Our high pressure Check Valves can be mounted in every position and offer the best performance with reduced pressure drops.

 Le nostre valvole di ritengo per CO₂ alte pressioni possono essere montate in qualunque posizione e offrono il migliore fattore di flusso con le minime perdite di carico.

 Unsere HD-Rückschlagventile für CO₂ können in jeder Stellung montiert werden und bieten den besten Durchflussfaktor bei minimalen Druckverlusten.

 Nos vannes à clapets pour le gaz CO₂ peuvent être montées dans toutes les positions et offrir la meilleure performance avec une pression réduite.

 Nuestras válvulas de retención para CO₂ de alta presión pueden ser montadas en cualquier posición y ofrecen el mejor factor de flujo con la mínimas pérdida de carga.

 As nossas válvulas de retenção para CO₂ de alta pressão podem ser montadas em qualquer posição e oferecem o melhor fator de fluxo com uma queda mínima de pressão.

 弊社チェック・バルブは、あらゆるポジションでマウントすることができ、減少されたプレッシャー・ドロップで、最高のパフォーマンスを提供することができます。

 Наши обратные клапаны для CO₂ высокого давления могут монтироваться в любом положении и обеспечивают лучший коэффициент потока при наименьших потерях давления.

transcritical R744 Check Valve

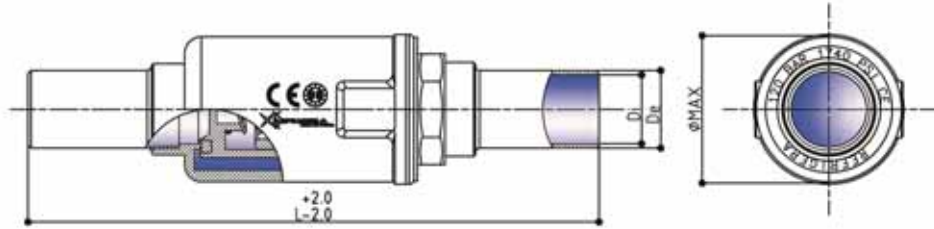

| Code | Connections Size According to ASME/ANSI B36.10 | Weight | Buttwelding Steel Tube Ø | | Lenght | Wide | P.E.D. |
|----------------------|--|--------|-----------------------------|-------------|-----------|--------------|------------------|
| REF | DN | (g) | Ø e (mm) | Ø i (mm) | L (mm) | ØMAX (mm) | Group2 fluids |
| REF3.1.N.006.1.120 * | | 98 | - | 6,2 | 106 | 24 | Art.3.3 |
| REF3.1.N.008.1.120 | | 100 | 8 | 5 | 112 | 24 | Art.3.3 |
| REF3.1.N.010.1.120 | | 100 | 10 | 8 | 112 | 24 | Art.3.3 |
| REF3.1.N.012.1.120 | | 100 | 12 | 10 | 121 | 24 | Art.3.3 |
| REF3.1.N.016.3.120 | | 295 | 16 | 14 | 152 | 36 | Art.3.3 |
| REF3.1.N.018.1.120 | | 395 | 18 | 16 | 152 | 36 | Art.3.3 |
| REF3.1.N.022.3.120 | | 400 | 22 | 18 | 200 | 37 | Art.3.3 |
| REF3.1.N.028.1.120 | | 1100 | 28 | 24 | 230 | 60 | Art.3.3 |
| REF3.1.N.032.3.120 | | 1575 | 35 | 31 | 240 | 65 | Art.3.3 |
| REF3.1.N.042.1.120 | 32 | 2545 | 42 | 35 | 270 | 80 | Art.3.3 |

W: Reduced Port

N: standard spring valve with minimum Opening Pressure Differential = 0,1 bar

R: reinforced spring valve with minimum Opening Pressure Differential = 0,3 bar

* **Cu-DHP Connections**





THE IMAGE SHOWS: a high pressure Check Valve.

 The changeover is a service device for safety valves that allows using one valve while isolating the other from the system. The valve ensures a pressure drop compatible with the safety valve operation under condition of discharge of saturated or overheated vapour.

 La valvola deviatrica è un rubinetto di servizio tra due valvole di sicurezza che esclude alternativamente l'una o l'altra permettendo interventi sull'impianto. Il rubinetto assicura una caduta di pressione compatibile con il funzionamento dei dispositivi di sicurezza in condizioni di scarico sia di vapore saturo che di vapore surriscaldato.

 Das Umleitventil ist ein Sperrhahn zwischen zwei Sicherheitsventilen, der abwechselnd das eine oder andere ausschließt und damit Eingriffe an der Anlage erlaubt. Der Hahn sichert einen Druckabfall, der mit dem Betrieb der Sicherheitsvorrichtungen sowohl bei Ableitung von gesättigtem als auch von überhitztem Dampf kompatibel ist.

 La vanne d'échange sert de robinet de service entre deux vannes de sécurité, en permettant simultanément l'utilisation de l'une et l'exclusion de l'autre. La vanne assure une chute de pression parfaitement compatible avec le fonctionnement du dispositif de sécurité des conditions d'évacuation, aussi bien de la vapeur saturée que de la vapeur de surchauffe.

 Las válvula de desviación es una llave de paso de servicio entre dos válvulas de seguridad que excluye alternativamente o una o la otra, permitiendo intervenciones en la instalación. Esta llave de paso asegura la caída de presión compatible con el funcionamiento de los dispositivos de seguridad en condiciones de descarga ya sea de vapor saturado que de vapor sobrecalentado.

 A válvula de desviadora é um registro de serviço entre duas válvulas de segurança que exclui alternadamente uma ou outra, isto para permitir de efetuar operações na instalação. O registro garante uma queda de pressão compatível com o funcionamento dos dispositivos de segurança em condições de descarregar, tanto o vapor saturado como o vapor superaquecido.

 チェンジオーバーは、ひとつのバルブを使用しながら他をシステムよりアイソレートすることを可能にする、セーフティー・バルブのためのサービス・デバイスです。同バルブは、サチュレートもしくはオーバーヒートした蒸気のディスチャージ、という条件下でのセーフティー・バルブ・オペレーションと互換性のあるプレッシャー・ドロップを、確保します。

 Перекидной клапан-вспомогательный кран между двумя предохранительными клапанами, который поочередно отключает один или другой клапан, позволяя, таким образом, производить вмешательство на установке. Кран обеспечивает падение давления, соответствующее функционированию предохранительных устройств при условиях выпуска, как насыщенного, так и перегретого пара.

transcritical R744 Changeover Valve

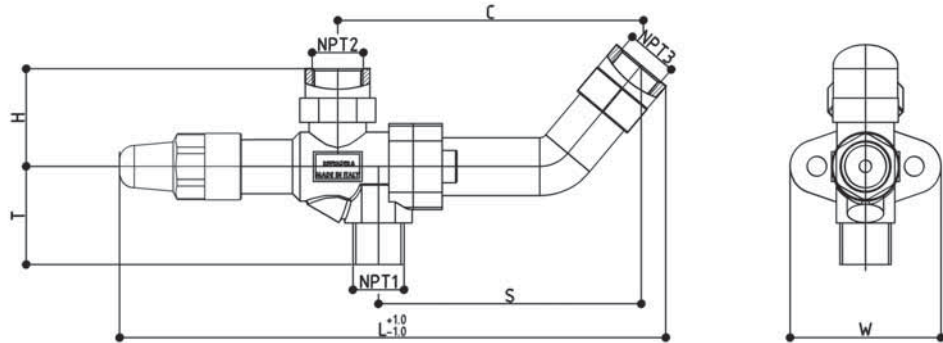
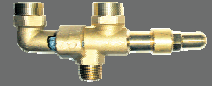



| Code | Connection NPT1 | Conn NPT2 | Conn NPT3 | Length | Height | Height | C | Wide | S | Kv | P.E.D. |
|--------------------|-----------------|-----------|-----------|--------|--------|--------|--------|--------|--------|---------------|---------------|
| REF | inches | inches | inches | L (mm) | H (mm) | T (mm) | C (mm) | W (mm) | S (mm) | P:1bar (m³/h) | Group2 fluids |
| REF2.1.012.012.012 | 1/2" | 1/2" | 1/2" | 225 | 40 | 40 | 125 | 62 | 108 | 1,0 | Art.3.3 |





THE IMAGE SHOWS: a 90bar high pressure Changeover Device.

 Valves are fitted with special seals suitable for R744 and are guaranteed for operating pressures up to 120bar. Bi-flow system allows the NPT Valves suitable to be used together with safety valve of the same Nominal Diameter.

 Le valvole sono dotate di guarnizioni speciali idonee per R744 e sono garantite per pressioni di esercizio fino a 120bar. Le valvole NPT sono adatte per essere utilizzate assieme alle valvole di sicurezza dello stesso diametro nominale.

 Die Ventile sind mit speziellen, für R744 geeignete Dichtungen ausgerüstet und werden für einen Betriebsdruck bis 120 Bar garantiert. Die NPT-Ventile eignen sich für den Einsatz zusammen mit Sicherheitsventilen des gleichen Nenndurchmessers.

 Les vannes sont équipées de joints spéciaux appropriés pour R744 et sont garantis pour des pressions jusqu'à 120bar. Les vannes NPT sont appropriées pour être utilisées avec les soupapes de sûreté du même diamètre nominal.

 Las válvulas están dotadas de guarniciones especiales idóneas para R744 y están garantizadas para presiones hasta 120 bar. Las válvulas NPT están adaptadas para ser utilizadas junto a las válvulas de seguridad del mismo diámetro nominal.

 As válvulas possuem vedações especiais apropriadas para R744 e são garantidas para pressões de exercício até 120 bar. As válvulas NPT são apropriadas para serem utilizadas junto com as válvulas de segurança com o mesmo diâmetro nominal.

 バルブは、R744に適した特別なシールによってフィットされ、最大120バーまでのオペレーション・プレッシャーに対して保証されています。弊社バイ・フロー・システムは、適切なNPTバルブが、同じ名目直径のセーフティー・バルブと一緒に使用されることを、可能にします。

 Клапаны оснащены специальными уплотнениями для R744 и гарантированы в давлениях до 120bar. Клапаны NPT предназначены для использования вместе с предохранительными клапанами с таким же номинальным диаметром.

transcritical R744 NPT Ball Valve

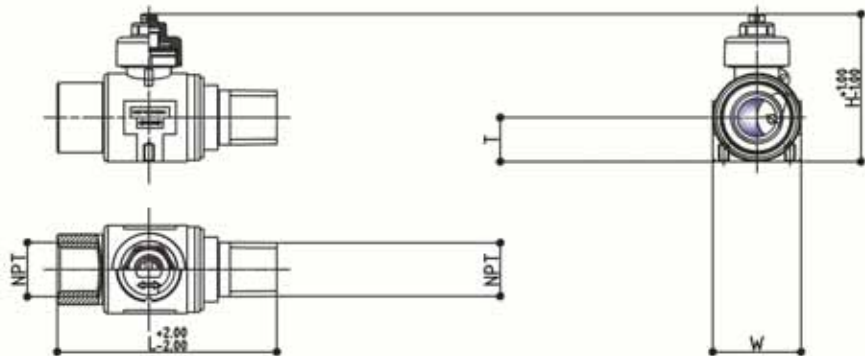



| Code | Connection | Weight | Sphere passage | Length | Height | Wide | V | T | Kv | WTemp | P.E.D. |
|-----------------------|------------|--------|----------------|--------|--------|--------|--------|--------|----------------|-----------|---------------|
| REF | DN | (g) | Ø (mm) | L (mm) | H (mm) | W (mm) | V (mm) | T (mm) | ΔP:1bar (m³/h) | °C | Group2 fluids |
| REF1.1.P.B.012.1.N120 | 1/2" | 360 | 15 | 85 | 56,5 | 34 | 24 | 17 | 13 | -40/ +150 | Art.3.3 |
| REF1.1.P.C.001.1.N120 | 1" | 890 | 19 | 120 | 85 | 46 | 35 | 26 | 24 | | Art.3.3 |





THE IMAGE SHOWS: an NPT Valve mounted with a Safety Valve on a Changeover Device.

 Completely made of brass, safety valves grant protection against possible overpressures of the refrigerating systems with regards to the operating conditions for which they have been designed.

 Interamente realizzate in ottone, le valvole di sicurezza garantiscono protezione contro eventuali sovrappressioni, rispetto alle condizioni di esercizio di progetto, delle componenti di sistemi di refrigerazione o condizionamento.

 Die Sicherheitsventile sind ganz aus Messing gefertigt und schützen unter normalen Betriebsbedingungen vor Überdruck in den Bauteilen der Kühl- oder Klimatisierungssysteme.

 Entièrement réalisées en laiton, les vannes de sécurité garantissent une protection contre les surpressions éventuelles, par rapport aux conditions de service pour lesquelles elles ont été conçues, dans les composants de systèmes de réfrigération.

 Totalmente realizadas en bronce, las válvulas de seguridad garantizan protección contra eventuales golpes de presión, con respecto a las condiciones de sistemas de refrigeración o acondicionamiento.

 Inteiramente produzidas em aço inoxidável, as válvulas de segurança garantem proteção contra quaisquer excesso de pressão, em relação às condições de exercício estabelecidas no projeto, dos componentes dos sistemas de refrigeração ou do condicionamento do ar.

 セーフティー・バルブは、完全に brass で作られており、これらがその為に設計されたところのオペレーション・コンディションに関連する、起こり得るリフリジレーション・システムのオーバープレッシャーに対するプロテクションを、提供します。

 Предохранительные клапаны, полностью выполненные из латуни, гарантируют защиту от возможного избыточного давления, по сравнению с проектными условиями эксплуатации.

transcritical R744 Safety Valve



SCARICO LIBERO
FREE OUTLET

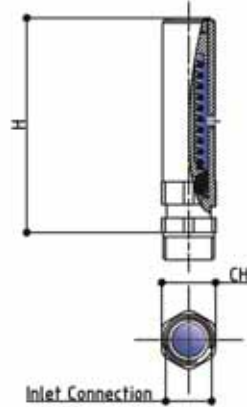

SCARICO CONVOGLIATO
PIPED OUTLET

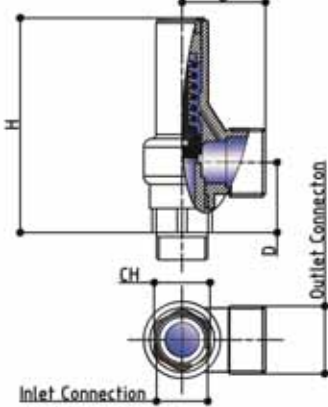



| Code | ID | Flow Diam. | H | D | B | CH | Inlet Conn. | Outlet Conn. | Setting | PN | Kv $\Delta P=1\text{bar}$ |
|--|----------|------------|-----|----|----|----|-------------|--------------|---------|-----|------------------------------|
| | | mm | mm | mm | mm | mm | NPT | GAS | bar | bar | m ³ /h |
| PRESSURE SETTINGS RANGE 61+100 BAR | | | | | | | | | | | |
| REF80.12.00.10.xxx | E10/S | 10 | 100 | - | - | 30 | 1/2" | FREE | 61+100 | 100 | 0,8 |
| REF80.34.00.10.xxx | E10/S | 10 | 100 | - | - | 30 | 3/4" | FREE | 61+100 | 100 | 0,8 |
| REF80.12.01.10.xxx | E10/LS | 10 | 106 | 31 | 42 | 30 | 1/2" | 1" | 61+100 | 100 | 0,8 |
| REF80.34.01.10.xxx | E10/LS | 10 | 106 | 31 | 42 | 30 | 3/4" | 1" | 61+100 | 100 | 0,8 |
| REF80.34.00.14.xxx | E14/S | 14 | 127 | - | - | 40 | 3/4" | FREE | 61+100 | 100 | 0,85 |
| REF80.01.00.14.xxx | E14/S | 14 | 127 | - | - | 40 | 1" | FREE | 61+100 | 100 | 0,85 |
| REF80.34.11.14.xxx | E14/LS | 14 | 154 | 35 | 50 | 40 | 3/4" | 1-1/4" | 61+100 | 100 | 0,85 |
| REF80.01.11.14.xxx | E14/LS | 14 | 154 | 35 | 50 | 40 | 1" | 1-1/4" | 61+100 | 100 | 0,85 |
| PRESSURE SETTINGS RANGE 100+150 BAR | | | | | | | | | | | |
| REF80.12.11.10.xxx | E10/L150 | 10 | 168 | 40 | 59 | 40 | 1/2" | 1-1/4" | 100+150 | 150 | 0,8 |
| REF80.34.11.10.xxx | E10/L150 | 10 | 168 | 40 | 59 | 40 | 3/4" | 1-1/4" | 100+150 | 150 | 0,8 |
| REF80.01.11.10.xxx | E10/L150 | 10 | 168 | 40 | 59 | 40 | 1" | 1-1/4" | 100+150 | 150 | 0,8 |
| REF80.01.17.14.xxx | E10/L150 | 10 | 168 | 40 | 59 | 40 | 1" | 1-1/2" | 100+150 | 150 | 0,8 |
| REF80.11.17.14.xxx | E10/L150 | 10 | 168 | 40 | 59 | 40 | 1-1/4" | 1-1/2" | 100+150 | 150 | 0,8 |





THE IMAGE SHOWS: Hot Forged brass high pressure Safety Valve

 The sight port, entirely turned from a single stainless steel bar, ensures endurance and lasting in the most extreme operating conditions. Thermally toughened Borosilicate glass, according to DIN 7080 maintain high resistance, temperature tolerance and high-grade transparency properties. The connections allow to mount AISI butt-welding tubes or Wieland K65-alloy.

 L'indicatore di liquido, tornito integralmente da barra d'acciaio inox, assicura doti di resistenza ed inalterabilità nelle più estreme condizioni di esercizio. L'ispezione in vetro temperato al Borosilicato DIN 7080, non teme l'alta pressione, gli sbalzi termici e possiede superiori doti di trasparenza. Le connessioni permettono di montare, alternativamente e su richiesta, tronchetti in acciaio per saldatura di testa TIG o tronchetti in lega Wieland K65.

 Die ganz aus einer Edelstahlleiste gedrehte Flüssigkeitsanzeige garantiert auch unter extremsten Betriebsbedingungen Resistenz und Beständigkeit. Das Schauglas aus gehärtetem Borosilikatglas DIN 7080 widersteht Hochdruck und Temperaturschwankungen und bietet eine höhere Transparenz. Die Verbindungen gestalten auf Anfrage die wechselweise Montage von Stahlstützen, die TIG-geschweißt werden oder von Stützen aus der Legierung CuFe2P.

 Le voyant indicateur de liquide, entièrement fondu dans une unique barre d'acier inoxydable, assure une résistance durable dans les conditions les plus extrêmes. Le verre borosilicate, trempé thermiquement selon la norme DIN 7080, permet de maintenir une forte résistance et tolérance à la température et ses propriétés de transparence face à des degrés élevés. Les connexions permettent de monter des tubes alliages AISI ou Wieland K65-CuFe2P.

 El indicador de líquido, torneado integralmente de una barra de acero inoxidable, asegura las dotes de resistencia e inalterabilidad en las más extremas condiciones de ejercicio. El vidrio de borosilicato DIN 7080 templado térmicamente, no teme la alta presión o los cambios de temperatura y posee grandes dotes de transparencia. Las conexiones permiten montar, alternativamente y por pedido, tramos en acero para soldaduras de cabeza TIG o tramos de aleación CuFe2P.

 O indicador de líquido, fabricado integralmente em uma barra de aço inox, assegura maior resistência e inalterabilidade em condições extremas de exercício. O visor em vidro temperado ao Borosilicato DIN 7080, é resistente à alta pressão, às variações térmicas e possui qualidades de transparência superior. As conexões permitem a montagem, como alternativa e sob pedido, de soquetes de aço para solda AISI ou de soquetes em liga CuFe2P.

 シングル・ステンレス・スチール・バーから全体が造出されているこのサイト・ポートは、最も厳しいオペレーティング・コンディションにおける、耐久性と継続性を確実にします。DIN 7080に従って熱加工的に強化されたボロシリケート・ガラスは、ハイ・レジスタンスで、耐温度性があり、そしてハイ・グレードな透明度プロパティを維持します。このコネクションは、AISIバット・ウェルディング・チューブ、もしくはCuFe2P-アロイ・チューブのマウントを可能にします。

 Индикатор жидкости, полностью превратился из одной штанги из нержавеющей стали, обеспечивает выносливость и прочность в самых экстремальных условиях эксплуатации. Термически закаленное боросиликатного стекла, в соответствии с DIN 7080 поддерживают высокую стойкость, температуру термичности и полные свойства прозрачности. Соединения позволяют монтировать AISI стьковой сварки труб или Виланд К65-сплава.

transcritical R744 Liquid Indicator

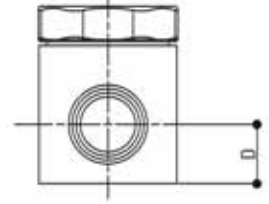
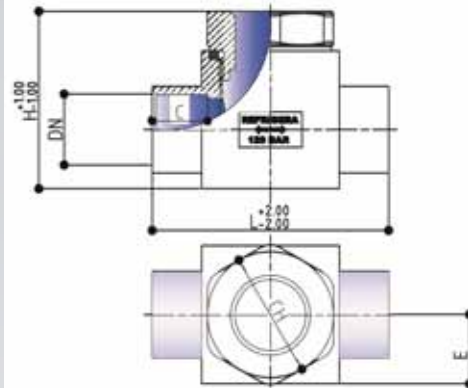
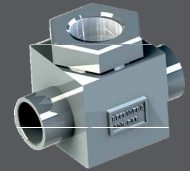

| Code | Dimensions | C | D | E | Length | Height | Spanner Meas | Kv | WTemp | P.E.D. |
|-----------------|------------|------|------|------|-----------|-----------|--------------|---|-----------|---------------|
| REF | ODS DN | (mm) | (mm) | (mm) | L (mm) | H (mm) | CH | $\Delta P: 1 \text{bar}$ (m ³ /h) | °C | Group2 fluids |
| REF60.61.07.010 | 10mm | 10 | 10 | 15 | 55 | 30 | 32 | 3,5 | | Art.3.3 |
| REF60.61.07.012 | 12mm | 10 | 15 | 17,5 | 55 | 46 | 32 | 5 | | Art.3.3 |
| REF60.61.07.016 | 16mm | 14 | 15 | 17,5 | 60 | 46 | 32 | 13 | | Art.3.3 |
| REF60.61.07.018 | 18mm | 14 | 12 | 15 | 60 | 35 | 32 | 24 | | Art.3.3 |
| REF60.61.07.022 | 22mm | 20 | 13 | 17,5 | 60 | 46 | 32 | 40 | -40/ +150 | Art.3.3 |
| REF60.61.07.028 | 28mm | 20 | 18 | 17,5 | 70 | 56 | 32 | 50 | | Art.3.3 |
| REF60.61.07.035 | 35mm | 20 | 18 | 18 | 70 | 45 | 32 | 67 | | Art.3.3 |



THE IMAGE SHOWS: High Pressure Liquid Indicator provided with socket - welding connections

Moisture contained in the fluid (p.p.m.)

Colour Refrigerant fluid

R744

Green <50

Yellow >50

 **AISI304 casted valve, customizable – on demand – mounting stainless steel tubes with butt-weld connections or CuFe2P (high resistance copper alloy) with ODS connections to braze, designed for R744 transcritical systems (PS 120bar) and suitable to all high pressure appliances.**

 **Valvola AISI304 pressofusa, personalizzabile - su richiesta - montando tubi in acciaio inox con attacchi a saldare o in CuFe2P (lega di rame ad alta resistenza) con collegamenti ODS a brasare, progettata per impianti a R744 ciclo-transcritico (PS 120bar) e adatta a tutte le applicazioni per l'alta pressione.**

 **Druckgussventil aus AISI304 für Edelstahlrohre mit zu schweißenden Anschlüssen, geplant für Anlagen mit R744 in transkritischem Zyklus (SD 120 Bar) und für alle Hochdruckenwendungen geeignet .**

 **La vanne coulée AISI304, avec le montage des tubes en acier inoxydable avec des connexions à souder conçue pour les systèmes R744 transcritique (PS 120bar) et adapté à tous les appareils à haute pression .**

 **Válvula fundida, tubos montantes en acero inoxidable con conexiones a soldar proyectada para instalaciones con sistema R744 (PS 120 bar) y adaptables a todos lo utensillos de alta presión.**

 **A válvula AISI304 fundida sob pressão, apresenta tubos em aço inoxidável com conexões para solda projetadas para instalações tipo R744 ciclo transcritical (PS 120 bar) e é apropriada para todas as aplicações com pressão elevada. A**

 **AISI 304キャスト・バルブは、バット・ウェルド・コネクショを伴う、R744トランスクリティカル・システム（PS120バー）向けにデザインされたステンレス・スチール・チューブをマウントし、すべてのハイ・プレッシャー・アプリケーションに適しています。**

 **AISI304 литыекран, настраиваемый - по желанию - с монтажа труб из нержавеющей стали с стыковой сварки соединений, предназначенные для R744 закритической систем (ПС 120bar) и подходит для всех высокого давления техника.**

transcritical R744 Ball Valve AISI304

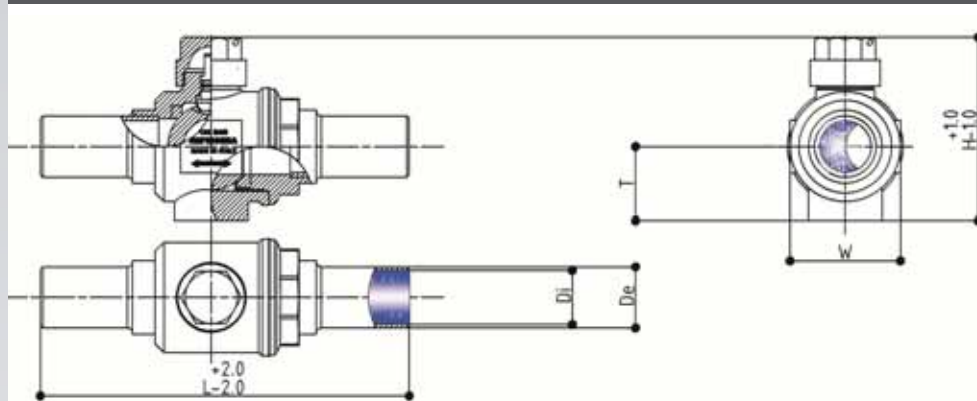



| Code | Connection | Weight | Sphere passage | Length | Height | Wide | T | Kv | WTemp | P.E.D. |
|--------------------|---------------------------|--------|----------------|-----------|-----------|-----------|-----------|-------------------|----------|---------------|
| REF | DN (ODS) Di(mm) De(mm) | (g) | Ø (mm) | L (mm) | H (mm) | W (mm) | T (mm) | ΔP:1bar (m³/h) | °C | Group2 fluids |
| REF1.1.N.J.D15.130 | 17,12 21,34 | 900 | 19 | 195 | 81 | 51 | 29 | 24 | | Art.3.3 |
| REF1.1.N.K.D20.130 | 22,45 26,67 | 950 | 19 | 195 | 81 | 51 | 29 | 40 | | Art.3.3 |
| REF1.1.N.W.D25.130 | 27,86 33,40 | 1950 | 32 | 210 | 101 | 67 | 40 | 67,3 | -40/+150 | Art.3.3 |
| REF1.1.N.X.D32.130 | 35,04 42,16 | 2150 | 32 | 230 | 101 | 68 | 40 | 76,8 | | Art.3.3 |
| REF1.1.N.Y.D40.120 | 40,90 48,26 | 3490 | 38 | 280 | 117 | 76 | 48 | 98 | | Class II |





PAG52 THE IMAGE SHOWS: a high pressure AISI304 Ball Valve

 AISI304 casted valve, customizable – on demand – mounting stainless steel tubes with butt-weld connections or CuFe2P (high resistance copper alloy) with ODS connections to braze, designed for R744 transcritical systems (PS 120bar) and suitable to all high pressure appliances.

 Valvola AISI304 pressofusa, personalizzabile - su richiesta - montando tubi in acciaio inox con attacchi a saldare o in CuFe2P (lega di rame ad alta resistenza) con collegamenti ODS a brasare, progettata per impianti a R744 ciclo-transcritico (PS 120bar) e adatta a tutte le applicazioni per l'alta pressione.

 Druckgussventil aus AISI304 für Edelstahlrohre mit zu schweißenden Anschlüssen, geplant für Anlagen mit R744 in transkritischem Zyklus (SD 120 Bar) und für alle Hochdruckanwendungen geeignet.

 La vanne coulée AISI304, avec le montage des tubes en acier inoxydable avec des connexions à souder conçue pour les systèmes R744 transcritique (PS 120bar) et adapté à tous les appareils à haute pression.

 Válvula fundida, tubos montantes en acero inoxidable con conexiones a soldar proyectada para instalaciones con sistema R744 (PS 120 bar) y adaptables a todos los utensillos de alta presión.

 A válvula AISI304 fundida sob pressão, apresenta tubos em aço inoxidável com conexões para solda projetadas para instalações tipo R744 ciclo transcritico (PS 120 bar) e é apropriada para todas as aplicações com pressão elevada.

 AISI 304キャストッド・バルブは、バット・ウェルド・コネクショを伴う、R744トランスクリティカル・システム (PS120/バー) 向けにデザインされたステンレス・スチール・チューブをマウントし、すべてのハイ・プレッシャー・アプライアンスに適しています。

 AISI304 литыеклапан, настраиваемый - по желанию - с монтажа труб из нержавеющей ста ли с стьжо вой с вар ки соединений, и предназначенные для R744 закритической систем (ПС 120bar) и подходит для всех высокого давления техника.

transcritical R744 3Way Ball Valve AISI304

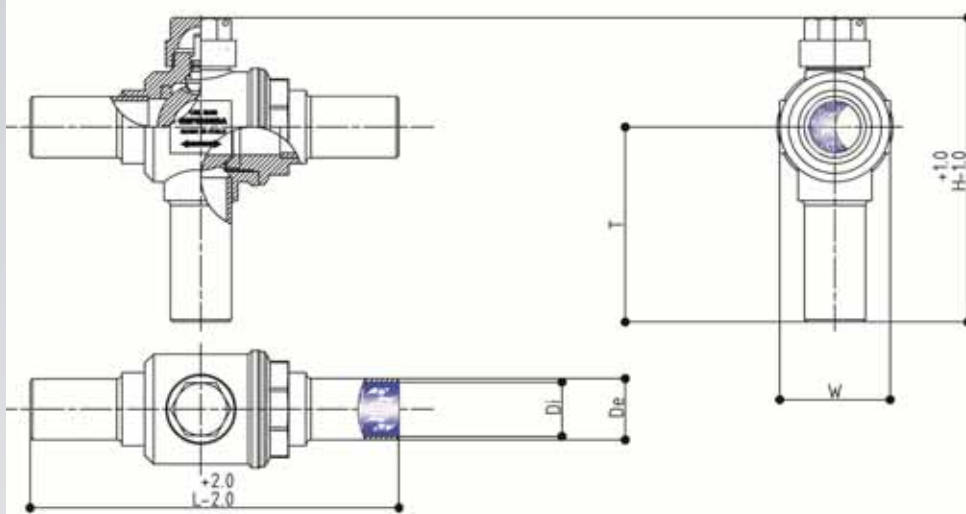



| Code | Connection | | Weight | Sphere passage | Length | Height | Wide | T | Kv | WTemp | P.E.D. |
|---------------------|--------------|--------|--------|----------------|-----------|-----------|-----------|-----------|-------------------|----------|---------------|
| REF | DN Øi(mm) | Øe(mm) | (g) | Ø(mm) | L (mm) | H (mm) | W (mm) | T (mm) | ØP:1bar (m³/h) | °C | Group2 fluids |
| REF1.1.N.J.D15.M130 | 17,12 | 21,34 | 922 | 19 | 195 | 140 | 51 | 88 | 10,3 | | Art.3.3 |
| REF1.1.N.K.D20.M130 | 22,45 | 26,67 | 950 | 19 | 195 | 140 | 51 | 88 | 10,3 | | Art.3.3 |
| REF1.1.N.W.D25.M130 | 27,86 | 33,40 | 2050 | 32 | 210 | 160 | 67 | 100 | 19,7 | -40/+150 | Art.3.3 |
| REF1.1.N.X.D32.M130 | 35,04 | 42,16 | 2300 | 32 | 230 | 170 | 67 | 107 | 19,7 | | Art.3.3 |
| REF1.1.N.Y.D40.M120 | 40,90 | 48,26 | 3520 | 38 | 280 | 201 | 76 | 132 | 39,5 | | Class II |



THE IMAGE SHOWS: a high pressure AISI304 three Way Ball Valve

 The DIN ISO-5211 standard flange, allows to fit valves with all the actuators on the market, when it is necessary the remote control of opening and closing or adjusting the direction of flow. The lever shaft is mounted in explosion-proof configuration and is hermetic airtight designed.

 La flangia ISO-DIN 5211 standard permette l'accoppiamento delle valvole con tutti gli attuatori attualmente presenti sul mercato per tutti i casi in cui sia necessario il controllo a distanza dell'apertura e chiusura o regolare la direzione del flusso. Il perno di manovra viene montato in configurazione antisceppio ed è progettato a tenuta ermetica.

 Der Standardflansch ISO-DIN 5211 ermöglicht in allen Fällen, in denen die Fernsteuerung der Öffnung und Schließung oder die Durchflussrichtung zu regeln ist, den Anschluss der Ventile an alle momentan auf dem Markt befindlichen Antriebe. Der Schaltzapfen wird mit einer Berstsicherung montiert und verfügt über eine hermetische Dichtung.

 La bride ISO-DIN 5211 standard permet de créer la paire de vannes pour tous les acteurs sur le marché aujourd'hui, pour tous les cas où il est nécessaire d'utiliser la télécommande d'ouverture et de fermeture ou de réglage de la direction du flux. Le levier est monté dans une configuration anti explosion, conçu hermétiquement avec le joint O-Ring R744, compatible pour le R744.

 La brida ISO-DIN 5211 estándar permite acopiar las válvulas con todos los actuadores presentes en el mercado en los cuales sea necesario el control a distancia de la apertura y cierre o para regular la dirección del flujo.

El perno de maniobra viene montado con configuración antideflagrante y fijado hermético.

 O flange padrão ISO-DIN 5211, permite o acoplamento das válvulas com todos os atuadores atualmente disponíveis no comércio para todos os casos em que for necessário controlar a distância, tanto a abertura como o fechamento ou então regular a direção do fluxo. O pivô é montado na configuração à prova de explosão e lacrado hermeticamente.

 DIN ISO-5211

水準の同フランジは、市場に存在するすべてのアクチュエーターにバルブをフィットさせることを可能とします。これは、開口と閉口、あるいはフローの方向調節をリモート・コントロールする際に必要となります。レバー・シャフトが、爆発防止の設定でマウントされており、完封エアタイト設計されています。

 Стандартный фланец DIN ISO-5211 позволяет соединению клапанов со всеми приводами рынка. Полезно в тех случаях, когда нужно удаленного контроля или регулирования открытия и закрытия потока. Рычаг вала осуществляет взрывобезопасную функцию и он герметично запечатан.

transcritical R744 B.V. fit for Actuator AISI304

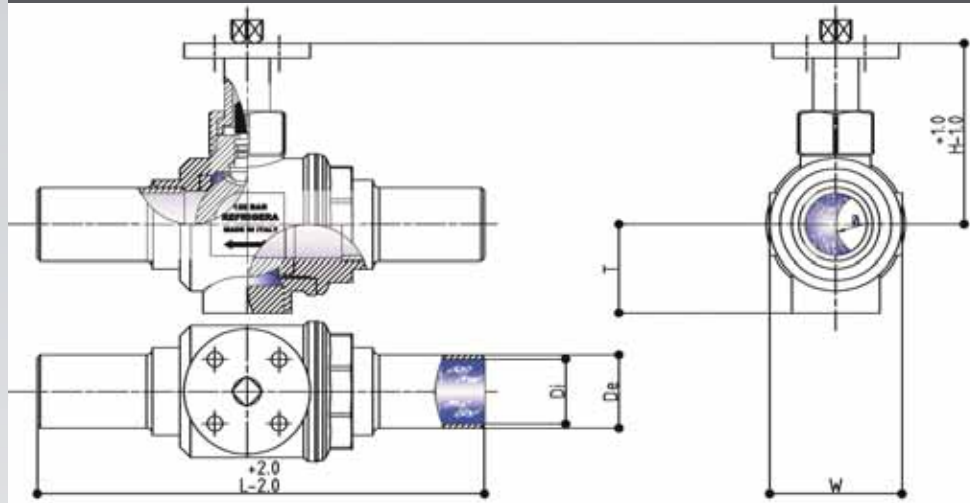



| Code | DN According to ASME/ANSI B36.10 | Connection | Weight | Sphere passage | Length | Height | Wide | T | Kv | WTemp | P.E.D. |
|---------------------|----------------------------------|-------------|--------|----------------|--------|--------|--------|--------|----------------|----------|---------------|
| REF | DN | Øe Øi (mm) | (g) | Ø(mm) | L (mm) | H (mm) | W (mm) | T (mm) | ΔP:1bar (m³/h) | °C | Group2 fluids |
| REF1.1.N.J.D15.P130 | 15 | 21,34 17,12 | 750 | 19 | 202 | 170 | 46 | 88 | 24 | | Art.3.3 |
| REF1.1.N.K.D20.P130 | 20 | 26,67 22,45 | 1076 | 19 | 195 | 170 | 46 | 88 | 40 | | Art.3.3 |
| REF1.1.N.W.D25.P130 | 25 | 33,40 27,86 | 1322 | 32 | 210 | 180 | 63 | 95 | 67,3 | -40/+150 | Art.3.3 |
| REF1.1.N.X.D32.P130 | 32 | 42,16 35,04 | 2400 | 32 | 230 | 180 | 63 | 95 | 76,8 | | Art.3.3 |
| REF1.1.N.Y.D40.P120 | 40 | 40,90 48,26 | 3990 | 38 | 280 | 144 | 76 | 95 | 98 | | Class II |



THE IMAGE SHOWS: High Pressure Ball Valve mounting rotary electrical actuator

 The DIN ISO-5211 standard flange, allows to fit valves with all the actuators on the market, when it is necessary the remote control of opening and closing or adjusting the direction of flow. The lever shaft is mounted in explosion-proof configuration and is hermetic airtight designed.

 La flangia ISO-DIN 5211 standard permette l'accoppiamento delle valvole con tutti gli attuatori attualmente presenti sul mercato per tutti i casi in cui sia necessario il controllo a distanza dell'apertura e chiusura o regolare la direzione del flusso. Il perno di manovra viene montato in configurazione antisceppio ed è progettato a tenuta ermetica.

 Der Standardflansch ISO-DIN 5211 ermöglicht in allen Fällen, in denen die Fernsteuerung der Öffnung und Schließung oder die Durchflussrichtung zu regeln ist, den Anschluss der Ventile an alle momentan auf dem Markt befindlichen Antriebe. Der Schaltzapfen wird mit einer Berstsicherung montiert und verfügt über eine hermetische Dichtung.

 La bride ISO-DIN 5211 standard permet de créer la paire de vannes pour tous les acteurs sur le marché aujourd'hui, pour tous les cas où il est nécessaire d'utiliser la télécommande d'ouverture et de fermeture ou de réglage de la direction du flux. Le levier est monté dans une configuration anti explosion, conçu hermétiquement avec le joint O-Ring R744, compatible pour le R744.

 La brida ISO-DIN 5211 estándar permite acopiar las válvulas con todos los actuadores presentes en el mercado en los cuales sea necesario el control a distancia de la apertura y cierre o para regular la dirección del flujo. El perno de maniobra viene montado con configuración antideflagrante y fijado herméticamente.

 O flange padrão ISO-DIN 5211, permite o acoplamento das válvulas com todos os atuadores atualmente disponíveis no comércio para todos os casos em que for necessário controlar à distância, tanto a abertura como o fechamento ou então regular a direção do fluxo. O pivô é montado na configuração à prova de explosão e lacrado hermeticamente.

 DIN ISO-5211 水準の同フランジは、市場に存在するすべてのアクチュエーターにバルブをフィットさせることを可能とします。これは、開口と閉口、あるいはフローの方向調節をリモート・コントロールする際に必要となります。レバー・シャフトが、爆発防止の設定でマウントされており、完封エアタイト設計されています。

 Стандартный фланец DIN ISO-5211 позволяет соединению клапанов со всеми приводами рынка. Полезно в тех случаях, когда нужно удаленного контроля или регулирования открытия и закрытия потока. Рычаг вала осуществляет взрывобезопасную функцию и он герметично запечатан.

transcritical R744 3Way B.V. fit for Actuator AISI304

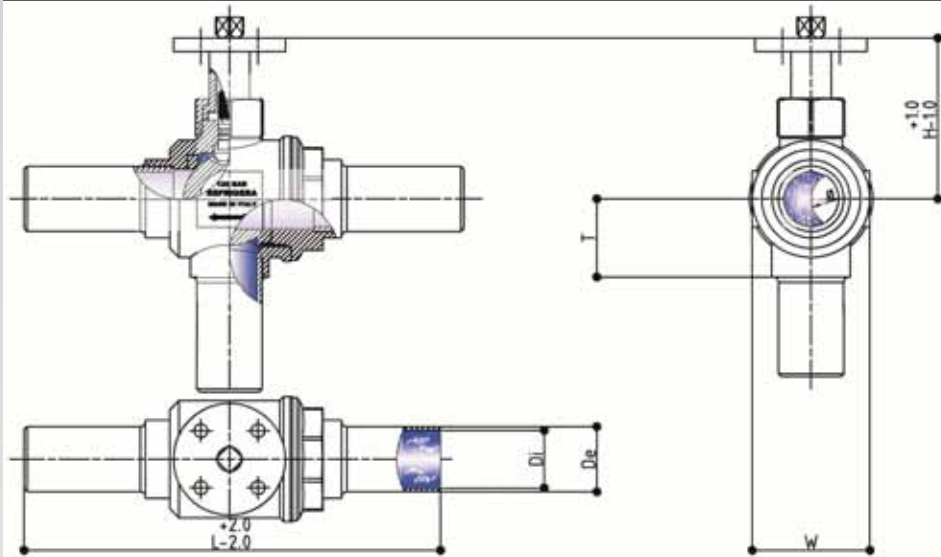

| Code | DN According to ASME/ANSI B36.10 | Connection | Weight | Sphere passage | Length | Height | Wide | T | Kv | WTemp | P.E.D. |
|----------------------|----------------------------------|-------------|--------|----------------|--------|--------|--------|--------|----------------|----------|---------------|
| REF | DN | De Di | (g) | Ø(mm) | L (mm) | H (mm) | W (mm) | T (mm) | ΔP:1bar (m³/h) | °C | Group2 fluids |
| REF1.1.N.J.D15.MP130 | 15 | 21,34 17,12 | 2300 | 19 | 202 | 170 | 46 | 88 | 10,3 | | Art.3.3 |
| REF1.1.N.K.D20.MP130 | 20 | 26,67 22,45 | 2300 | 19 | 195 | 170 | 46 | 88 | 10,3 | | Art.3.3 |
| REF1.1.N.W.D25.MP130 | 25 | 33,40 27,86 | 2400 | 32 | 210 | 180 | 63 | 100 | 19,7 | -40/+150 | Art.3.3 |
| REF1.1.N.X.D32.MP130 | 32 | 42,16 35,04 | 2400 | 32 | 230 | 180 | 63 | 107 | 19,7 | | Art.3.3 |
| REF1.1.N.Y.D40.MP120 | 40 | 40,90 48,26 | 4020 | 38 | 280 | 228 | 76 | 132 | 39,5 | | Class II |



THE IMAGE SHOWS: High Pressure Ball Valve mounting rotary electrical actuator

CuFe2P The tube system for high-pressure applications

In refrigeration, and in particular in the area of supermarket refrigeration systems, more and more ecology-oriented plant concepts are being implemented. The modern, environment-friendly refrigerant CO₂ (R744) that is used here leads to high operating pressures. For these applications the new **CuFe2P** tube system is available. Tubes and fittings are made of the high-strength copper alloy CuFe2P which has already been used with success in electrical engineering and

the automotive industry. CuFe2P allows economical installation of refrigeration systems with operating pressures up to 120 bar. **CuFe2P** has good processing properties which are similar to those of copper. **CuFe2P** tubes may be hard-soldered to **CuFe2P** fittings. The main advantage is the mechanical strength of **CuFe2P**. Because of the high strength of the material, the **CuFe2P** product series for 120 bar can be made with comparatively thin walls. The light weight of pipelines

made of **CuFe2P** means not only a significant saving in material, but also easier handling, for example when mounting the tubes on ceilings. The processing instructions for the installation of copper tubes according to EN 378 common for refrigeration are to be followed. Any type of silver hard solder with a minimum silver content of 2% may currently be used. The safety precautions for high-pressure systems, particularly for pressure testing and commissioning have to be observed.



Special Components manufactured with Stainless Steel or CuFe2P high strength connections

Continuous Improvement

Refrigera Industriale SRL aims to become for the next years a world's leading diversified manufacturer of joint, headers, valves and adapters for R744 transcritical HVACR and VRF, providing precision-engineered solutions - according to ISO 9001/2008 and to European legislation 97/23/EC (Pressure Equipment Directive) - for a wide variety of commercial and industrial markets in the main types:

Full bore ball valves with DN from 6 mm to 35 mm bi-directional type, available with preloading, 2 or 3 way, with or

without electric actuator.

Non-return valves (check valves) with NB between 6 mm and 80 mm (3-1/8")

Indicators and humidity sensible element, consisting of a coloured indicator which shows the value of moisture.

Bent connecting pipes

A/C Piping systems Fittings

New projects are a challenge to promote the usage of CO₂, also witnessed by the constant involvement (now as a Silver Partner) in www.R744.com website, the largest community of CO₂ commercial and industrial

CuFe2P is a high-copper alloy combining medium electrical and thermal conductivity with medium strength. Good hardening is achieved by finely dispersed iron precipitation in the structure.

Because of these properties, is used for electronic components such as connectors and switches.



CuFe2P high strength rod

| Material Designation | |
|----------------------|--------|
| EN | CuFe2P |

| Chemical Composition | |
|----------------------|-------------|
| Cu | min. 97,00% |
| Fe | 2,30% |
| Zn | 0,12% |
| P | 0,03% |

| Typical Applications |
|------------------------------------|
| Components for Electrical industry |
| Stamped Parts |
| Connectors |
| Leadframes for semiconductors |

| Physical Properties* | | |
|--|----------------------|-------|
| Electrical Conductivity | %IACS | 63.8 |
| Thermal Conductivity | Btu/(ft·h·°F) | 162 |
| Coefficient of Electrical Resistance** | 10 ⁻³ /°F | 1.8 |
| Coefficient of Thermal Expansion** | µin/(in·°F) | 9.8 |
| Density | lb/in ³ | 0.317 |
| Modulus of Elasticity | 10 ⁶ psi | 17.8 |
| Specific Heat | Btu/(lb·°F) | 0.092 |

| Fabrication Properties | |
|----------------------------------|---------------|
| Capacity for being Cold Worked | good |
| Machinability | less suitable |
| Capacity for being Electroplated | good |
| Capacity for being Ho-DipTinned | excellent |
| Soft Soldering | excellent |
| Resistance Welding | good |
| Gas Shielded Arc Welding | excellent |
| Laser Welding | good |

Corrosion Resistance

CuFe2P exhibits good corrosion resistance in natural atmosphere (also sea air) and industrial atmosphere.

In different waters' and neutral saline solutions, it shows best resistance to corrosion through abrasion and pitting.

Insensitive to stress corrosion cracking

* Reference values at room temperature
 ** Between 30°F and 600°F

| Mechanical Properties | Temper | O60 | H02 | H04 | H06 | H08 | H10 |
|---|--------|---------|---------|---------|------------|---------|-----------|
| | | soft | ½ hard | hard | extra hard | spring | ex spring |
| Tensile Strength | ksi | 40 - 50 | 53 - 63 | 60 - 70 | 67 - 73 | 70 - 76 | 73 - 80 |
| Hardness HR 30-T (for information only) | | - | 52 - 63 | 61 - 68 | 67 - 69 | 68 - 69 | 69 - 70 |

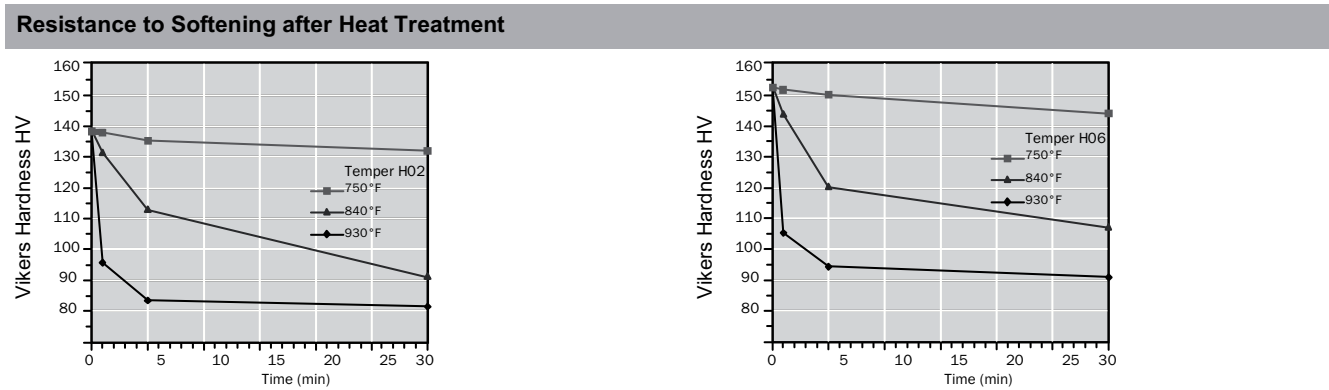
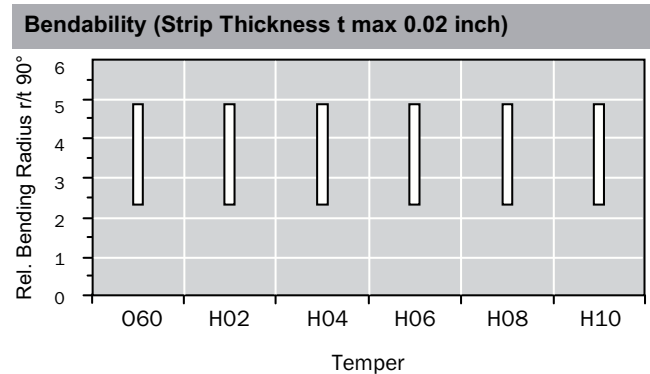
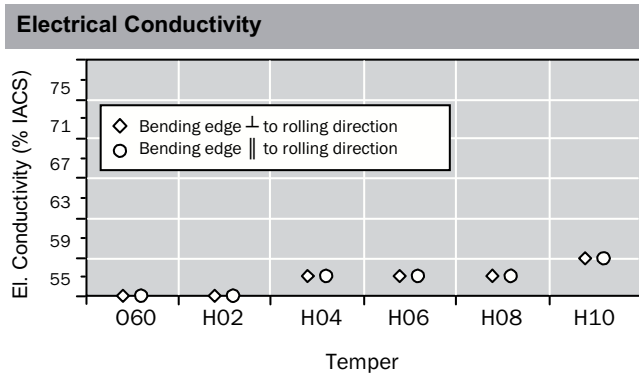

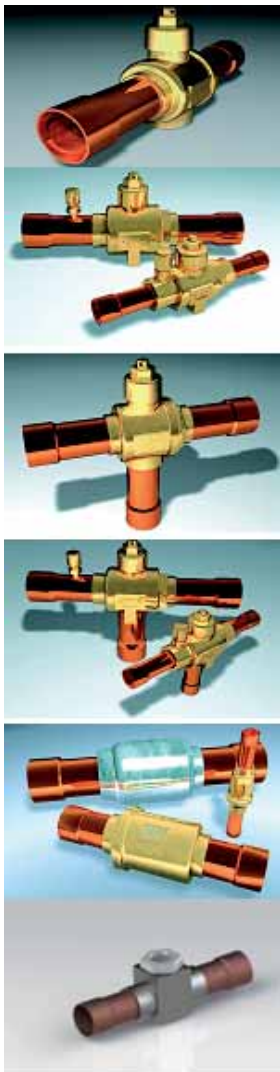

Valves and Fittings made of CuFe2P

Relaxation at Stress Level 0,5xYield Strength

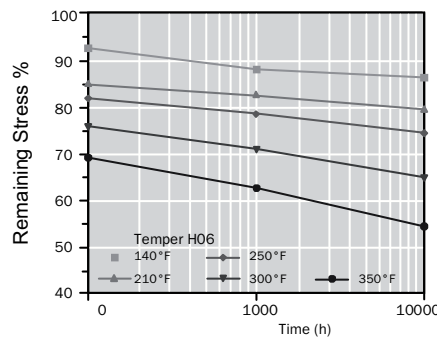

Stress remaining as a function of service temperature and time. Measured on stress relief annealed specimens parallel to rolling direction. Values extrapolated according to F.R. Larson, J. Miller, Trans ASME74 (1952) 765 - 775.

Due to plastic deformation different relaxation values are to be expected

Fatigue Strength

The fatigue strength is defined as the maximum bending stress amplitude which a material withstands for 10^7 load cycles under symmetrical alternate load without breaking. It is dependent on the temper tested and is about 1/3 of the tensile strength.

Design

For calculations related to pressure vessel made of ductile copper materials, the 1,0% proof stress may be used instead of the 0,2% proof stress if the ratio of the 0,2% proof stress to the tensile strength $>0,5$ and the elongation at fracture in the transverse direction is the last 25%, or at least 27% in the longitudinal direction.

$$s = \frac{Da \cdot p}{20 \frac{K}{S} v \cdot p} \cdot c1 \cdot c2$$

| | | | |
|----|-------------------|----|-------------------------------------|
| s | Thickness | S | Security Factor |
| Da | External Diameter | c1 | Reduced Thickness Corrective Factor |
| P | Pressure | c2 | Wear and tear Corrective Factor |
| K | Resistance Factor | v | Reduced Tensile stress zone Factor |

Brazing recommendation

In the refrigeration industry, copper materials are brazed with copper-phosphoric alloys (CuP), silver-copper-phosphoric alloys (AgCuP) or cadmium-free silver brazing alloys. The new copper material **CuFe2P** was developed for applications with high-pressure refrigerants (R410A, CO₂) as opposed to the conventional Cu-DHP (99.9% Cu), this material is a CuFe2P alloy. The alloy composition of **CuFe2P** may be used for brazing with silver brazing alloys without any restrictions.

In the presence of significant overlapping lengths, it might be advisable to use the BrazeTec h paste flux for better gap filling.

The recommended brazing alloys are listed in chart 1. The selection of brazing alloy depends also on other factors (vibration, operating temperatures) and must be clarified with the brazing alloy supplier for each specific application.

| Brazing alloy | DIN EN ISO 17672 | DVGW-Number | Working Temperature (°C) | Composition (% by Weight) | | | | |
|---------------------|------------------|---------------|--------------------------|---------------------------|------|------|-----|-----|
| | | | | Ag | Cu | Zn | Sn | P |
| Braze Tec 4576 | Ag145 | DV-0105CM0043 | 610 | 45 | 27 | 25,5 | 2,5 | - |
| Braze Tec 3476 | Ag145 | DV-0105CM0045 | 710 | 34 | 36 | 27,5 | 2,5 | - |
| Braze Tec 4404 | Ag145 | DV-0105CM0044 | 730 | 44 | 30 | 26 | - | - |
| Braze Tec Silfos 15 | CuP284 | - | 700 | 15 | 80 | - | - | 5,0 |
| Braze Tec Silfos 5 | CuP281 | - | 700 | 5 | 89 | - | - | 6,0 |
| Braze Tec Silfos 2 | CuP279 | DV-0105CM0075 | 740 | 2 | 91,7 | - | - | 6,3 |

| Flux | DIN EN ISO 1046 | DVGW-Number | Active Temperature (°C) | Annotations |
|-------------|-----------------|---------------|-------------------------|---|
| | | | | Flux residues are corrosive and must be removed |
| Braze Tec h | FH10 | DV-0101AU2227 | 550-970 | |

 A new bi-flow valve for high performance systems in high pressure carbon dioxide plants - R744 (trans-critical cycle). The CW617N brass valve-body ensures endurance and lasting in the most extreme operating conditions. The CuFe2P alloy connections allow, in addition the brazing through silver alloys without any restriction. Valves are fitted with special seals suitable for R744.

 Una nuova valvola bi-flow altamente performante per impianti in alta pressione ad R744 (ciclo trans-critico). Il corpo valvola in ottone CW617N assicura doti di resistenza ed inalterabilità nelle più estreme condizioni di esercizio. I tronchetti in lega CuFe2P permettono, inoltre, il normale accoppiamento agli impianti tramite brasatura attraverso le consuete leghe d'argento. Le valvole sono dotate di guarnizioni speciali idonee per R744.

 Ein neues, hochleistungsfähiges Biflow-Ventil für Hochdruckanlagen mit R744 (transkritischer Zyklus). Der Ventilkörper ist aus Messing CW617N und gewährleistet auch unter extremsten Betriebsbedingungen Resistenz und Beständigkeit. Mit den Stutzen aus der Legierung CuFe2P kann man auch den normalen Anschluss an die Anlagen durch Löten mit den üblichen Silberlegierungen herstellen. Die Ventile sind mit speziellen, für R744 geeignete Dichtungen ausgerüstet.

 Une nouvelle vanne de haute performance des systèmes à haute pression-R744 (cycle trans-critique). Le corps de la vanne en laiton CW617N assure une forte résistance dans les conditions les plus extrêmes. L'alliage CuFe2P permet des connexions avec les alliages d'argent pour braser, sans aucune restriction. Les vannes sont équipées de joints spéciaux appropriés pour R744.

 Una nueva válvula bi-flow altamente performante para instalaciones de alta presión a R744 (ciclo trans-critico). El cuerpo de la válvula en bronce CW617N asegura dotes de resistencia y inalterabilidad en las más extremas condiciones de ejercicio. Los troncos CuFe2P fusionados, permiten además el normal acoplamiento a las instalaciones por medio de soldadura a través de las habituales aleaciones de argento. Las válvulas están dotadas de guarniciones especiales idóneas para R744.

 A nova válvula bi-flow apresenta alta performance nas instalações com pressão elevada R744 (ciclo trans-critico). O corpo da válvula em latão CW617N assegura maior resistência e inalterabilidade em condições extremas de exercício. Os soquetes realizados em liga CuFe2P, também permitem o normal acoplamento com as instalações mediante brasagem com as habituais ligas de prata. As válvulas possuem vedações especiais apropriadas para R744.

 新規バイ・フロー・バルブ。ハイ・プレッシャー・カーボン・ダイオキサイド・プラントの中の、ハイ・パフォーマンス・システム向け。このCW617Nプラス・バルブ・ボディは、最も厳しいオペレーティング・コンディション中における、耐久性と継続性を確実にします。このCuFe2Pアロイ・コネクションはさらに、いかなる制限も無しに、シルバー・アロイをブレイジング・スルーすることを可能にします。バルブは、R744に適した特別なシールによってフィットされます。

 Новый клапан высокопроизводительных систем при высоком давлении-R744 (закритический цикл). Латунь CW617N обеспечивает прочность в экстремальных условиях. Потрубки из CuFe2P позволяют соединение с оборудованием через пайку серебряным сплавом. Клапаны оснащены специальными уплотнениями для R744.

transcritical R744 Ball Valve CuFe2P

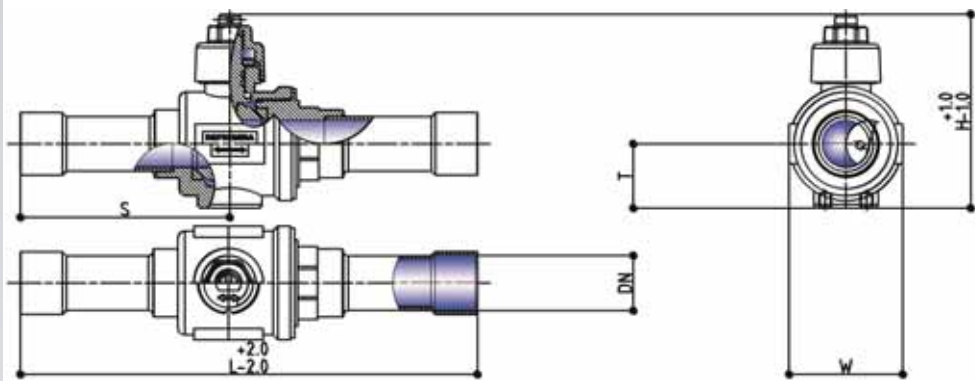
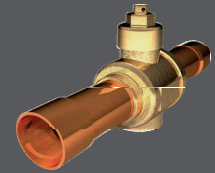



| Code | Connection | Weight | Sphere passage | Length | Height | Wide | S | T | Kv | WTemp | P.E.D. |
|----------------------|-------------|--------|----------------|--------|--------|--------|--------|--------|----------------|-----------|---------------|
| REF | DN | (g) | Ø(mm) | L (mm) | H (mm) | W (mm) | S (mm) | T (mm) | ΔP:1bar (m³/h) | °C | Group2 fluids |
| REF1.1.N.A.006.1.120 | 6mm | 90 | 8 | 99 | 40 | 24 | 63 | 12 | 2,4 | | Art.3.3 |
| REF1.1.N.A.006.2.120 | 3/4" | 90 | 8 | 99 | 40 | 24 | 63 | 12 | 2,4 | | Art.3.3 |
| REF1.1.N.A.010.K65 | 10mm | 108 | 8 | 132 | 40 | 24 | 63 | 12 | 2,4 | | Art.3.3 |
| REF1.1.N.A.038.K65 | 3/8" | 108 | 8 | 132 | 40 | 24 | 63 | 12 | 2,4 | | Art.3.3 |
| REF1.1.N.A.012.K65 | 12mm | 120 | 8 | 139 | 40 | 24 | 67 | 12 | 2,7 | | Art.3.3 |
| REF1.1.N.A.127.K65 | 1/2" | 120 | 8 | 139 | 40 | 24 | 67 | 12 | 2,7 | | Art.3.3 |
| REF1.1.N.B.015.K65 | 15mm | 360 | 15 | 148 | 60 | 34 | 68 | 17 | 12,5 | | Art.3.3 |
| REF1.1.N.B.016.K65 | 16mm 5/8" | 360 | 15 | 148 | 60 | 34 | 68 | 17 | 13 | | Art.3.3 |
| REF1.1.N.B.018.K65 | 18mm | 360 | 15 | 148 | 60 | 34 | 68 | 17 | 14 | -40/ +150 | Art.3.3 |
| REF1.1.N.B.034.K65 | 3/4" | 360 | 15 | 148 | 60 | 34 | 68 | 17 | 14 | | Art.3.3 |
| REF1.1.N.C.022.K65 | 22mm 7/8" | 750 | 19 | 185 | 80 | 46 | 85 | 26 | 24 | | Art.3.3 |
| REF1.1.N.D.028.K65 | 28mm | 1076 | 25 | 185 | 85 | 52 | 90 | 28 | 40 | | Art.3.3 |
| REF1.1.N.D.118.K65 | 1-1/8" | 1076 | 25 | 185 | 85 | 52 | 90 | 28 | 40 | | Art.3.3 |
| REF1.1.N.E.035.K65 | 35mm 1-3/8" | 1322 | 32 | 205 | 100 | 66 | 95 | 35 | 67,3 | | Class I |
| REF1.1.N.F.042.K65 | 42mm | 2400 | 40 | 240 | 115 | 76 | 115 | 48 | 98 | | Class I |
| REF1.1.N.F.158.K65 | 1-5/8" | 2400 | 40 | 240 | 115 | 76 | 115 | 48 | 98 | | Class I |

 A new bi-flow valve for high performance systems in high pressure carbon dioxide plants - R744 (trans-critical cycle). The CW617N brass valve-body ensures endurance and lasting in the most extreme operating conditions. The CuFe2P alloy connections allow, in addition the brazing through silver alloys without any restriction.

 Una nuova valvola bi-flow altamente performante per impianti in alta pressione ad R744 (ciclo trans-critico). Il corpo valvola in ottone CW617N assicura doti di resistenza ed inalterabilità nelle più estreme condizioni di esercizio. I tronchetti in lega CuFe2P permettono, inoltre, il normale accoppiamento agli impianti tramite brasatura attraverso le consuete leghe d'argento.

 Ein neues, hochleistungsfähiges Bi-Flow-Ventil für Hochdruckanlagen mit R744 (transkritischer Zyklus). Der Ventilkörper ist aus Messing CW617N und gewährleistet auch unter extremsten Betriebsbedingungen Resistenz und Beständigkeit. Mit den Stutzen aus der Legierung CuFe2P kann man auch den normalen Anschluss an die Anlagen durch Löten mit den üblichen Silberlegierungen herstellen. Die Ventile sind mit speziellen, für R744 geeignete Dichtungen ausgerüstet.

 Une nouvelle vanne de haute performance des systèmes à haute pression-R744 (cycle trans-critique). Le corps de la vanne en laiton CW617N assure une forte résistance dans les conditions les plus extrêmes. L'alliage CuFe2P permet des connexions avec les alliages d'argent pour braser, sans aucune restriction. Les vannes sont équipées de joints spéciaux appropriés pour R744.

 Una nueva válvula bi-flow altamente performante para instalaciones de alta presión a R744 (ciclo trans-critico). El cuerpo de la válvula en bronce CW617N asegura dotes de resistencia y inalterabilidad en las más extremas condiciones de ejercicio. Los troncos CuFe2P fusionados, permiten además el normal acoplamiento a las instalaciones por medio de soldadura a través de las habituales aleaciones de argento. Las válvulas están dotadas de guarniciones especiales idóneas para R744.

 A nova válvula bi-flow apresenta alta performance nas instalações com pressão elevada R744 (ciclo trans-critico). O corpo da válvula em latão CW617N assegura maior resistência e inalterabilidade em condições extremas de exercício. Os soquetes realizados em liga CuFe2P, também permitem o normal acoplamento com as instalações mediante brasagem com as habituais ligas de prata. As válvulas possuem vedações especiais apropriadas para R744.

 新規バイ・フロー・バルブ。ハイ・プレッシャー・カーボン・ダイオキサイド・プラントの中の、ハイ・パフォーマンス・システム向け。このCW617Nプラス・バルブ・ボディは、最も厳しいオペレーティング・コンディション中における、耐久性と継続性を確実にします。このCuFe2Pアロイ・コネクションはさらに、いかなる制限も無しに、シルバー・アロイをブレイジング・スルーすることを可能にします。バルブは、R744に適した特別なシールによってフィットされます。

 Новый клапан высокопроизводительных систем при высоком давлении-R744 (закритический цикл). Латунь CW617N обеспечивает прочность в экстремальных условиях. Потрубки из CuFe2P позволяют соединению с оборудованием через пайку серебряным сплавом.

transcritical R744 Schrader™-Port B.V. CuFe2P

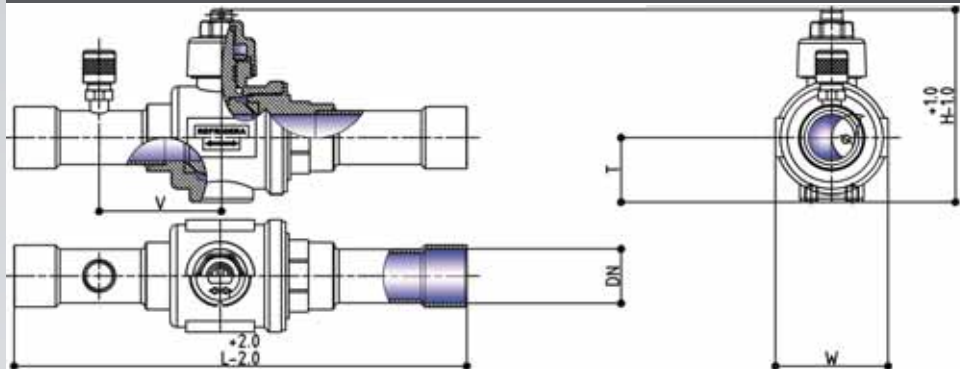
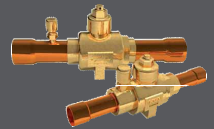



| Code | Connection | Weight | Sphere passage | Length | Height | Wide | S | T | Kv | WTemp | P.E.D. |
|----------------------|------------|--------|----------------|--------|--------|--------|--------|--------|----------------|-----------|---------------|
| REF | DN | (g) | Ø (mm) | L (mm) | H (mm) | W (mm) | S (mm) | T (mm) | ΔP:1bar (m³/h) | °C | Group2 fluids |
| REF1.1.S.A.006.1.120 | 6mm | 90 | 8 | 126 | 40 | 24 | 63 | 12 | 1,0 | | Art.3.3 |
| REF1.1.S.A.006.2.120 | 1/4" | 90 | 8 | 126 | 40 | 24 | 63 | 12 | 1,0 | | Art.3.3 |
| REF1.1.S.A.010.K65 | 10mm | 108 | 8 | 132 | 40 | 24 | 63 | 12 | 2,4 | | Art.3.3 |
| REF1.1.S.A.038.K65 | 3/8" | 108 | 8 | 132 | 40 | 24 | 63 | 12 | 2,4 | | Art.3.3 |
| REF1.1.S.A.012.K65 | 12mm | 120 | 8 | 139 | 40 | 24 | 67 | 12 | 2,7 | -40/ +150 | Art.3.3 |
| REF1.1.S.A.127.K65 | 1/2" | 120 | 8 | 139 | 40 | 24 | 67 | 12 | 2,7 | | Art.3.3 |
| REF1.1.S.B.015.K65 | 15mm | 360 | 15 | 148 | 60 | 34 | 68 | 17 | 12,5 | | Art.3.3 |
| REF1.1.S.B.016.K65 | 16mm 5/8" | 360 | 15 | 148 | 60 | 34 | 68 | 17 | 13 | | Art.3.3 |
| REF1.1.S.B.018.K65 | 18mm | 360 | 15 | 148 | 60 | 34 | 68 | 17 | 14 | | Art.3.3 |
| REF1.1.S.B.034.K65 | 3/4" | 360 | 15 | 148 | 60 | 34 | 68 | 17 | 14 | | Art.3.3 |





 Incoming capacity comes from the vertical Tube (always open) and valve allows you to redirect the flow either along one of the two horizontal output directions. The CuFe2P alloy connections allow, in addition the brazing through silver alloys without any restriction. Valves are fitted with special seals suitable for R744.

 La capacità in entrata proviene dal tubo verticale (sempre aperto) e la valvola consente di reindirizzare il flusso orizzontalmente lungo una delle due sezioni di scarico. I tronchetti in lega CuFe2P permettono, inoltre, il normale accoppiamento agli impianti tramite brasatura attraverso le consuete leghe d'argento. Le valvole sono dotate di guarnizioni speciali idonee per R744.

 Die Eintrittskapazität wird durch das vertikale Rohr (immer offen) gegeben, das Ventil ermöglicht den horizontalen Durchfluss entlang einem der zwei der Ablaufbereiche weiterzuleiten. Mit den Stutzen aus der Legierung CuFe2P kann man auch den normalen Anschluss an die Anlagen durch Löten mit den üblichen Silberlegierungen herstellen. Die Ventile sind mit speziellen, für R744 geeignete Dichtungen ausgerüstet.

 La capacité est transportée par le conduit vertical (toujours ouvert) et la vanne permet de rediriger le flux le long d'une des deux sections horizontales d'échappement. L'alliage CuFe2P permet des connexions avec les alliages d'argent pour braser, sans aucune restriction. Les vannes sont équipées de joints spéciaux appropriés pour R744.

 La capacidad de entrada proviene del tubo vertical (siempre abierto) y la válvula consiente de redireccionar el flujo horizontalmente a lo largo de una de las dos secciones de descarga. Los tramos CuFe2P fusionados permiten, además, el normal acoplamiento a las instalaciones por medio de soldadura a través de las habituales aleaciones de plata. Las válvulas están dotadas de guarniciones especiales idóneas para R744.

 O fluxo de entrada é proveniente do tubo vertical (sempre aberto) e a válvula permite redirecionar o fluxo horizontal ao longo de uma das duas seções de descarga. Os soquetes realizados em liga CuFe2P, também permitem o normal acoplamento com as instalações mediante brasagem com as habituais ligas de prata. As válvulas possuem vedações especiais apropriadas para R744.

 入来キャパシティーは、垂直チューブより浸入します（常時開口）。バルブにより、フローをふたつの水平アウトプットのうちのどちらかひとつに沿うように、変更することが可能です。このCuFe2Pアロイ・コネクションはさらに、いかなる制限も無しに、シルバー・アロイをブレージング・スルーすることを可能にします。バルブは、R744に適した特別なシールによってフィットされます。

 Поток поступает из вертикальной трубы (всегда открытая) и клапан позволяет направить его вдоль одной из двух горизонтально расположенных труб. Потрубки из CuFe2P позволяют соединение с оборудованием через пайку серебряным сплавом. Клапаны оснащены специальными уплотнениями для R744.

transcritical R744 3Way Ball Valve CuFe2P

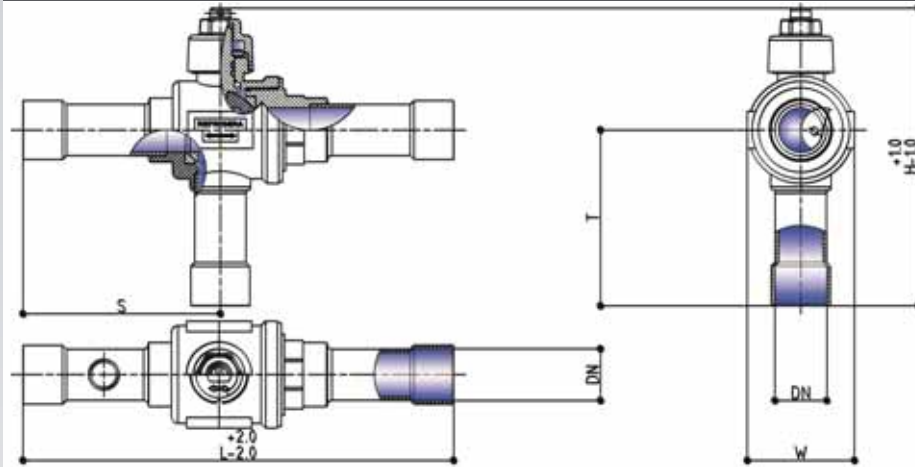



| Code | Connection | Weight | Sphere passage | Length | Height | Wide | S | T | Kv | WTemp | P.E.D. |
|----------------------|-------------|--------|----------------|--------|--------|--------|--------|--------|----------------|-----------|---------------|
| REF | DN | (g) | Ø (mm) | L (mm) | H (mm) | W (mm) | S (mm) | T (mm) | ΔP:1bar (m³/h) | °C | Group2 fluids |
| REF1.1.S.A.006.1M120 | 6mm | 90 | 8 | 126 | 40 | 24 | 63 | 46 | 1,0 | | Art.3.3 |
| REF1.1.S.A.006.2M120 | 1/4" | 90 | 8 | 126 | 40 | 24 | 63 | 46 | 1,0 | | Art.3.3 |
| REF1.1.S.A.010.MK65 | 10mm | 108 | 8 | 132 | 40 | 24 | 63 | 48 | 2,4 | | Art.3.3 |
| REF1.1.S.A.038.MK65 | 3/8" | 108 | 8 | 132 | 40 | 24 | 63 | 48 | 2,4 | | Art.3.3 |
| REF1.1.S.A.012.MK65 | 12mm | 120 | 8 | 139 | 40 | 24 | 67 | 48 | 2,7 | | Art.3.3 |
| REF1.1.S.A.127.MK65 | 1/2" | 120 | 8 | 139 | 40 | 24 | 67 | 48 | 2,7 | | Art.3.3 |
| REF1.1.N.A.010.MK65 | 10mm | 108 | 10 | 132 | 74 | 24 | 63 | 48 | 1,8 | | Art.3.3 |
| REF1.1.N.A.038.MK65 | 3/8" | 108 | 10 | 132 | 74 | 24 | 63 | 48 | 1,8 | | Art.3.3 |
| REF1.1.N.A.012.MK65 | 12mm | 120 | 10 | 139 | 74 | 24 | 67 | 53 | 2,7 | | Art.3.3 |
| REF1.1.N.A.127.MK65 | 1/2" | 120 | 10 | 139 | 74 | 24 | 67 | 53 | 2,7 | | Art.3.3 |
| REF1.1.S.B.015.MK65 | 15mm | 360 | 15 | 148 | 109 | 34 | 24 | 61 | 5,5 | | Art.3.3 |
| REF1.1.S.B.016.MK65 | 16mm 5/8" | 360 | 15 | 148 | 109 | 34 | 24 | 61 | 5,6 | | Art.3.3 |
| REF1.1.S.B.018.MK65 | 18mm | 360 | 15 | 148 | 109 | 34 | 24 | 61 | 5,8 | -40/ +150 | Art.3.3 |
| REF1.1.S.B.034.MK65 | 3/4" | 360 | 15 | 148 | 109 | 34 | 24 | 61 | 5,8 | | Art.3.3 |
| REF1.1.N.B.015.MK65 | 15mm | 360 | 15 | 148 | 109 | 34 | 68 | 61 | 5,5 | | Art.3.3 |
| REF1.1.N.B.016.MK65 | 16mm 5/8" | 360 | 15 | 148 | 109 | 34 | 68 | 61 | 5,6 | | Art.3.3 |
| REF1.1.N.B.018.MK65 | 18mm | 360 | 15 | 148 | 109 | 34 | 68 | 61 | 5,8 | | Art.3.3 |
| REF1.1.N.B.034.MK65 | 3/4" | 360 | 15 | 148 | 109 | 34 | 68 | 61 | 5,8 | | Art.3.3 |
| REF1.1.N.C.022.MK65 | 22mm 7/8" | 750 | 19 | 185 | 138 | 46 | 85 | 79 | 10,3 | | Art.3.3 |
| REF1.1.N.D.028.MK65 | 28mm | 1076 | 25 | 185 | 138 | 52 | 90 | 89 | 15,5 | | Art.3.3 |
| REF1.1.N.D.118.MK65 | 1-1/8" | 1076 | 25 | 185 | 146 | 52 | 90 | 89 | 15,5 | | Art.3.3 |
| REF1.1.N.E.035.MK65 | 35mm 1-3/8" | 1322 | 32 | 205 | 146 | 66 | 95 | 94 | 26,3 | | Class I |
| REF1.1.N.F.042.MK65 | 42mm | 2400 | 40 | 240 | 180 | 76 | 115 | 113 | 39,5 | | Class I |
| REF1.1.N.F.158.MK65 | 1-5/8" | 2400 | 40 | 240 | 180 | 76 | 115 | 113 | 39,5 | | Class I |

*CONNECTION KIT ARE SOLD SEPARATELY: PLS REFER TO CONNECTION KIT PAGE

 Our bi-flow system allows the mounting of the valve without taking into consideration the direction of the flow. The valve allows you to redirect the flow either along one of the two horizontal output directions.

 Il brevettato sistema bidirezionale permette di montare la valvola indipendentemente dalla direzione del flusso. La valvola consente di reindirizzare il flusso orizzontalmente lungo una delle due sezioni di scarico.

 Das patentierte Biflow-System ermöglicht die Montage des Ventils unabhängig von der Strömungsrichtung. Das Ventil ermöglicht den horizontalen Durchfluss entlang einem der zwei Ablaufbereiche weiterzuleiten.

 Notre système bi-directionnel permet d'installer la vanne sans se préoccuper de la direction du flux. La vanne permet de rediriger le flux le long d'une des deux sections horizontales d'échappement.

 El sistema bidireccional patentado permite montar la válvula independientemente de la dirección del flujo. La válvula consiente de redireccionar el flujo horizontalmente a lo largo de las dos secciones de desagüe.

 O sistema bidireccional patenteado permite de montar a válvula independentemente da direção do fluxo. A válvula permite redireccionar o fluxo horizontal ao longo de uma das duas seções de descarga.

 弊社バイ・フロー・システムは、フローの方向を考慮に入れないバルブのマウンティングを可能にします。バルブにより、フローをふたつの水平アウトプットのうちのどちらかひとつに沿うように、変更することが可能です。

 Наша двунаправленная система позволяет монтировать клапан без учёта направления потока. Клапан позволяет направить его вдоль одной из двух горизонтально расположенных труб.

transcritical R744 4Way Ball Valve CuFe2P

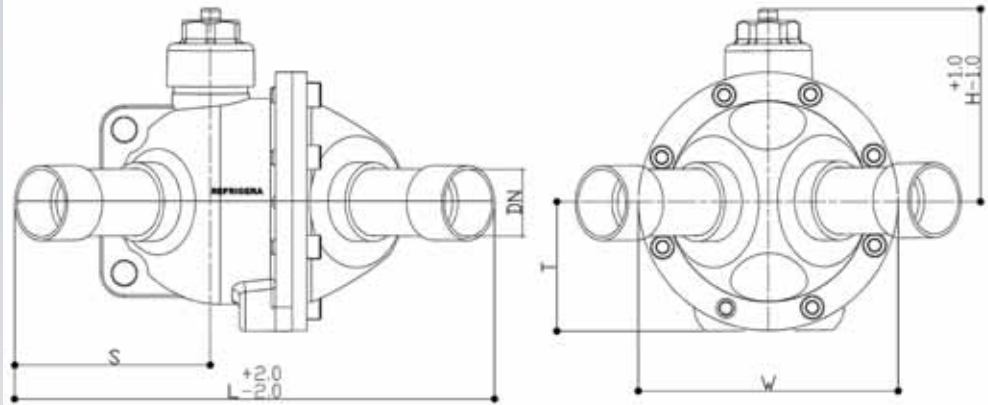
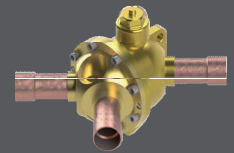



| Code | Connections Size According to ASME/ANSI B36.10 | Weight | Lenght | Lenght | Height | Height | Wide | Kvs | P.E.D. |
|--------------|--|--------|--------|--------|--------|--------|--------|----------------|---------------|
| REF | DN | (g) | S (mm) | L (mm) | T (mm) | H (mm) | W (mm) | ΔP:1bar (m³/h) | Group2 fluids |
| REF4.0.022.3 | 22 | - | - | - | - | - | - | - | Art.3.3 |
| REF4.0.028.1 | 28 | - | - | - | - | - | - | - | Art.3.3 |
| REF4.0.028.1 | 1-1/8" | - | - | - | - | - | - | - | Art.3.3 |



THE IMAGE SHOWS: 4Way Reversing Valve mounting CuFe2P Connections

 The DIN ISO-5211 standard flange, allows to fit valves with all the actuators on the market, when it is necessary the remote control of opening and closing or adjusting the direction of flow. The lever shaft is mounted in explosion-proof configuration and is hermetic airtight designed. Valves are fitted with special seals suitable for R744.

 La flangia ISO-DIN 5211 standard permette l'accoppiamento delle valvole con tutti gli attuatori attualmente presenti sul mercato per tutti i casi in cui sia necessario il controllo a distanza dell'apertura e chiusura o regolare la direzione del flusso. Il perno di manovra viene montato in configurazione antisceppio ed è progettato a tenuta ermetica. Le valvole sono dotate di guarnizioni speciali idonee per R744.

 Der Standardflansch ISO-DIN 5211 ermöglicht in allen Fällen, in denen die Fernsteuerung der Öffnung und Schließung oder die Durchflussrichtung zu regeln ist, den Anschluss der Ventile an alle momentan auf dem Markt befindlichen Antriebe. Der Schaltzapfen wird mit einer Berstsicherung montiert und verfügt über eine hermetische Dichtung.

 La bride ISO-DIN 5211 standard permet de créer la paire de vannes pour tous les acteurs sur le marché aujourd'hui, pour tous les cas où il est nécessaire d'utiliser la télécommande d'ouverture et de fermeture ou de réglage de la direction du flux. Le levier est monté dans une configuration anti explosion, conçu hermétiquement avec le joint O-Ring R744, compatible pour le R744.

 La brida ISO-DIN 5211 estándar permite acopiar las válvulas con todos los actuadores presentes en el mercado en los cuales sea necesario el control a distancia de la apertura y cierre o para regular la dirección del flujo. El perno de maniobra viene montado con configuración antideflagrante y fijado hermético.

 O flange padrão ISO-DIN 5211, permite o acoplamento das válvulas com todos os atuadores atualmente disponíveis no comércio para todos os casos em que for necessário controlar à distância, tanto a abertura como o fechamento ou então regular a direção do fluxo. O pivô é montado na configuração à prova de explosão e lacrado hermeticamente.

 DIN ISO-5211 水準の同フランジは、市場に存在するすべてのアクチュエーターにバルブをフィットさせることを可能とします。これは、開口と閉口、あるいはフローの方向調節をリモート・コントロールする際に必要となります。レバー・シャフトが、爆発防止の設定でマウントされており、完封エアタイト設計されています。

 Стандартный фланец DIN ISO-5211 позволяет соединению клапанов со всеми приводами рынка. Полезно в тех случаях, когда нужно удаленного контроля или регулирование открытия и закрытия потока. Рывок вала осуществляет взрывобезопасную функцию и герметично запечатан. Клапаны оснащены специальными уплотнениями для R744

transcritical R744 B.V. fit for Actuator CuFe2P

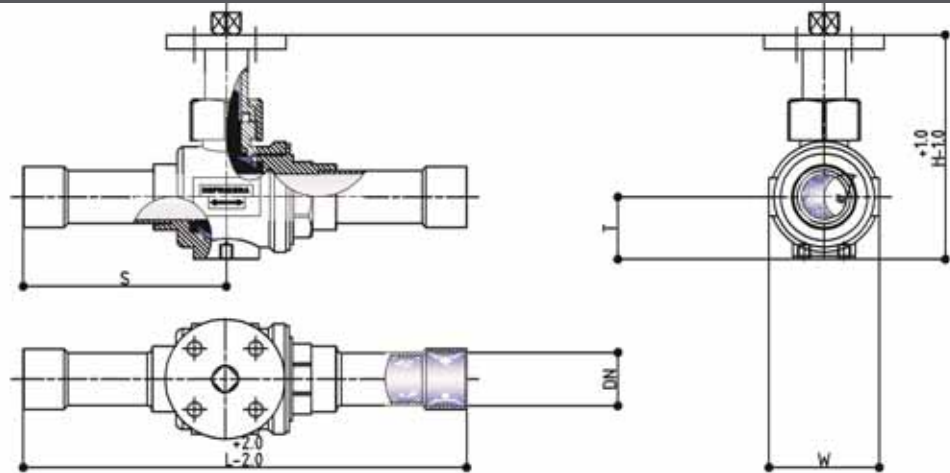



| Code | Connection | Weight | Sphere passage | Length | Height | Wide | S | T | Kv | WTemp | P.E.D. |
|-----------------------|-------------|--------|----------------|--------|--------|--------|--------|--------|----------------|-----------|---------------|
| REF | DN | (g) | Ø (mm) | L (mm) | H (mm) | W (mm) | S (mm) | T (mm) | DP:1bar (m3/h) | °C | Group2 fluids |
| REF1.1.S.A.006.1.P120 | 6mm | 90 | 8 | 126 | 40 | 24 | 63 | 12 | 1,0 | | Art.3.3 |
| REF1.1.S.A.006.2.P120 | 1/4" | 90 | 8 | 126 | 40 | 24 | 63 | 12 | 1,0 | | Art.3.3 |
| REF1.1.S.A.010.PK65 | 10mm | 108 | 8 | 132 | 40 | 24 | 63 | 12 | 2,4 | | Art.3.3 |
| REF1.1.S.A.038.PK65 | 3/8" | 108 | 8 | 132 | 40 | 24 | 63 | 12 | 2,4 | | Art.3.3 |
| REF1.1.S.A.012.PK65 | 12mm | 120 | 8 | 139 | 40 | 24 | 67 | 12 | 2,7 | | Art.3.3 |
| REF1.1.S.A.127.PK65 | 1/2" | 120 | 8 | 139 | 40 | 24 | 67 | 12 | 2,7 | | Art.3.3 |
| REF1.1.S.B.015.PK65 | 15mm | 360 | 15 | 148 | 60 | 34 | 68 | 17 | 12,5 | | Art.3.3 |
| REF1.1.S.B.016.PK65 | 16mm 5/8" | 360 | 15 | 148 | 60 | 34 | 68 | 17 | 13 | | Art.3.3 |
| REF1.1.S.B.018.PK65 | 18mm | 360 | 15 | 148 | 60 | 34 | 68 | 17 | 14 | -20/ +100 | Art.3.3 |
| REF1.1.S.B.034.PK65 | 3/4" | 360 | 15 | 148 | 60 | 34 | 68 | 17 | 14 | | Art.3.3 |
| REF1.1.S.C.022.PK65 | 22mm 7/8" | 750 | 19 | 185 | 80 | 46 | 85 | 26 | 24 | | Art.3.3 |
| REF1.1.S.D.028.PK65 | 28mm | 1076 | 25 | 185 | 85 | 52 | 90 | 28 | 40 | | Art.3.3 |
| REF1.1.S.D.118.PK65 | 1-1/8" | 1076 | 25 | 185 | 85 | 52 | 90 | 28 | 40 | | Art.3.3 |
| REF1.1.S.E.035.PK65 | 35mm 1-3/8" | 1322 | 32 | 205 | 100 | 66 | 95 | 35 | 67,3 | | Class I |
| REF1.1.S.F.042.PK65 | 42mm | 2400 | 40 | 240 | 115 | 76 | 115 | 48 | 98 | | Class I |
| REF1.1.S.F.158.PK65 | 1-5/8" | 2400 | 40 | 240 | 115 | 76 | 115 | 48 | 98 | | Class I |

*CONNECTION KIT ARE SOLD SEPARATELY. PLS REFER TO CONNECTION KIT PAGE

 The DIN ISO-5211 standard flange, allows to fit valves with all the actuators on the market, when it is necessary the remote control of opening and closing or adjusting the direction of flow. The lever shaft is mounted in explosion-proof configuration and is hermetic airtight designed. Valves are fitted with special seals suitable for R744.

 La flangia ISO-DIN 5211 standard permette l'accoppiamento delle valvole con tutti gli attuatori attualmente presenti sul mercato per tutti i casi in cui sia necessario il controllo a distanza dell'apertura e chiusura o regolare la direzione del flusso. Il perno di manovra viene montato in configurazione antisceppio ed è progettato a tenuta ermetica. Le valvole sono dotate di guarnizioni speciali idonee per R744.

 Der Standardflansch ISO-DIN 5211 ermöglicht in allen Fällen, in denen die Fernsteuerung der Öffnung und Schließung oder die Durchflussrichtung zu regeln ist, den Anschluss der Ventile an alle momentan auf dem Markt befindlichen Antriebe. Der Schaltzapfen wird mit einer Berstsicherung montiert und verfügt über eine hermetische Dichtung.

 La bride ISO-DIN 5211 standard permet de créer la paire de vannes pour tous les acteurs sur le marché aujourd'hui, pour tous les cas où il est nécessaire d'utiliser la télécommande d'ouverture et de fermeture ou de réglage de la direction du flux. Le levier est monté dans une configuration anti explosion, conçu hermétiquement avec le joint O-Ring R744, compatible pour le R744.

 La brida ISO-DIN 5211 estándar permite acopiar las válvulas con todos los actuadores presentes en el mercado en los cuales sea necesario el control a distancia de la apertura y cierre o para regular la dirección del flujo. El perno de maniobra viene montado con configuración antideflagrante y fijado hermético.

 O flange padrão ISO-DIN 5211, permite o acoplamento das válvulas com todos os atuadores atualmente disponíveis no comércio para todos os casos em que for necessário controlar a distância, tanto a abertura como o fechamento ou então regular a direção do fluxo. O pivô é montado na configuração à prova de explosão e lacrado hermeticamente.

 DIN ISO-5211

水準の同フランジは、市場に存在するすべてのアクチュエーターにバルブをフィットさせることを可能とします。これは、開口と閉口、あるいはフローの方向調節をリモート・コントロールする際に必要となります。レバー・シャフトが、爆発防止の設定でマウントされており、完封エアタイト設計されています。

 Стандартный фланец ISO-DIN 5211 позволяет соединению клапанов со всеми приводами рынка. Полезно в тех случаях, когда нужно удаленного контроля или регулирования открытия и закрытия потока. Рычаг вала осуществляет взрывобезопасную функцию и герметично запечатан. Клапаны оснащены специальными уплотнениями для R744

transcritical R744 3Way B.V. fit for Actuator CuFe2P

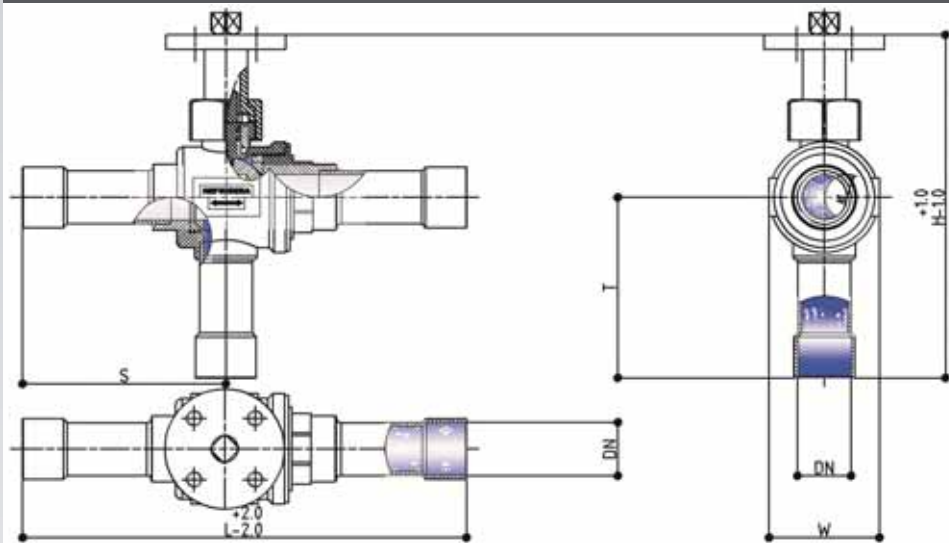



| Code | Connection | Weight | Sphere passage | Length | Height | Wide | S | T | Kv | WTemp | P.E.D. |
|------------------------|-------------|--------|----------------|--------|--------|--------|--------|--------|----------------|-----------|---------------|
| REF | DN | (g) | Ø (mm) | L (mm) | H (mm) | W (mm) | S (mm) | T (mm) | ΔP:1bar (m3/h) | °C | Group2 fluids |
| REF1.1.S.A.006.1.MP120 | 6mm | 90 | 8 | 126 | 40 | 24 | 63 | 48 | 0,8 | | Art.3.3 |
| REF1.1.S.A.006.2.MP120 | 1/4" | 90 | 8 | 126 | 40 | 24 | 63 | 48 | 0,8 | | Art.3.3 |
| REF1.1.S.A.010.MPK65 | 10mm | 108 | 10 | 132 | 74 | 25 | 65 | 48 | 1,8 | | Art.3.3 |
| REF1.1.N.B.038.MPK65 | 3/8" | 108 | 10 | 132 | 74 | 25 | 65 | 48 | 1,8 | | Art.3.3 |
| REF1.1.N.B.012.MPK65 | 12mm | 120 | 10 | 139 | 74 | 25 | 70 | 53 | 2,7 | | Art.3.3 |
| REF1.1.N.B.127.MPK65 | 1/2" | 120 | 10 | 139 | 74 | 25 | 70 | 53 | 2,7 | | Art.3.3 |
| REF1.1.N.B.015.MPK65 | 15mm | 360 | 15 | 148 | 109 | 34 | 68 | 61 | 5,5 | | Art.3.3 |
| REF1.1.N.B.016.MPK65 | 16mm 5/8" | 360 | 15 | 148 | 109 | 34 | 68 | 61 | 5,6 | | Art.3.3 |
| REF1.1.N.B.018.MPK65 | 18mm | 360 | 15 | 148 | 109 | 34 | 68 | 61 | 5,8 | -20/ +100 | Art.3.3 |
| REF1.1.N.B.034.MPK65 | 3/4" | 360 | 15 | 148 | 109 | 34 | 68 | 61 | 5,8 | | Art.3.3 |
| REF1.1.N.C.022.MPK65 | 22mm 7/8" | 750 | 19 | 185 | 138 | 46 | 85 | 79 | 10,3 | | Art.3.3 |
| REF1.1.N.D.028.MPK65 | 28mm | 1076 | 25 | 185 | 138 | 52 | 90 | 89 | 15,5 | | Art.3.3 |
| REF1.1.N.D.118.MPK65 | 1-1/8" | 1076 | 25 | 185 | 146 | 52 | 90 | 89 | 15,5 | | Art.3.3 |
| REF1.1.N.E.035.MPK65 | 35mm 1-3/8" | 1322 | 32 | 205 | 146 | 66 | 95 | 94 | 19,7 | | Class I |
| REF1.1.N.F.042.MPK65 | 42mm | 2400 | 40 | 240 | 180 | 76 | 115 | 113 | 39,5 | | Class I |
| REF1.1.N.F.158.MPK65 | 1-5/8" | 2400 | 40 | 240 | 180 | 76 | 115 | 113 | 39,5 | | Class I |

*CONNECTION KIT SOLD SEPARATELY: PLS REFER TO CONNECTION KIT PAGE

 The DIN ISO-5211 standard flange, allows to fit valves with all the actuators on the market, when it is necessary the remote control of opening and closing or adjusting the direction of flow. The lever shaft is mounted in explosion-proof configuration and is hermetic airtight designed.

 La flangia ISO-DIN 5211 standard permette l'accoppiamento delle valvole con tutti gli attuatori attualmente presenti sul mercato per tutti i casi in cui sia necessario il controllo a distanza dell'apertura e chiusura o regolare la direzione del flusso. Il perno di manovra viene montato in configurazione antisceppio ed è progettato a tenuta ermetica.

 Der Standardflansch ISO-DIN 5211 ermöglicht in allen Fällen, in denen die Fernsteuerung der Öffnung und Schließung oder die Durchflussrichtung zu regeln ist, den Anschluss der Ventile an alle momentan auf dem Markt befindlichen Antriebe. Der Schaltzapfen wird mit einer Berstsicherung montiert und verfügt über eine hermetische Dichtung.

 La bride ISO-DIN 5211 standard permet de créer la paire de vannes pour tous les acteurs sur le marché aujourd'hui, pour tous les cas où il est nécessaire d'utiliser la télécommande d'ouverture et de fermeture ou de réglage de la direction du flux. Le levier est monté dans une configuration anti explosion, conçu hermétiquement avec le joint O-Ring.

 La brida ISO-DIN 5211 estándar permite acopiar las válvulas con todos los actuadores presentes en el mercado en los cuales sea necesario el control a distancia de la apertura y cierre o para regular la dirección del flujo. El perno de maniobra viene montado con configuración antideflagrante y fijado hermético.

 O flange padrão ISO-DIN 5211, permite o acoplamento das válvulas com todos os atuadores atualmente disponíveis no comércio para todos os casos em que for necessário controlar à distância, tanto a abertura como o fechamento ou então regular a direção do fluxo. O pivô é montado na configuração à prova de explosão e lacrado hermeticamente.

 DIN ISO-5211水準の同フランジは、市場に存在するすべてのアクチュエーターにバルブをフィットさせることを可能とします。これは、開口と閉口、あるいはフローの方向調節をリモート・コントロールする際に必要となります。レバー・シャフトが、爆発防止の設定でマウントされており、完封エアタイト設計されています。

 Стандартный фланец DIN ISO-5211 позволяет соединению клапанов со всеми приводами рынка. Полезно в тех случаях, когда нужно удаленного контроля или регулирования открытия и закрытия потока. Рычаг вала осуществляет взрывобезопасную функцию и он герметично запечатан.

transcritical R744 4Way B.V. fit for Actuator CuFe2P

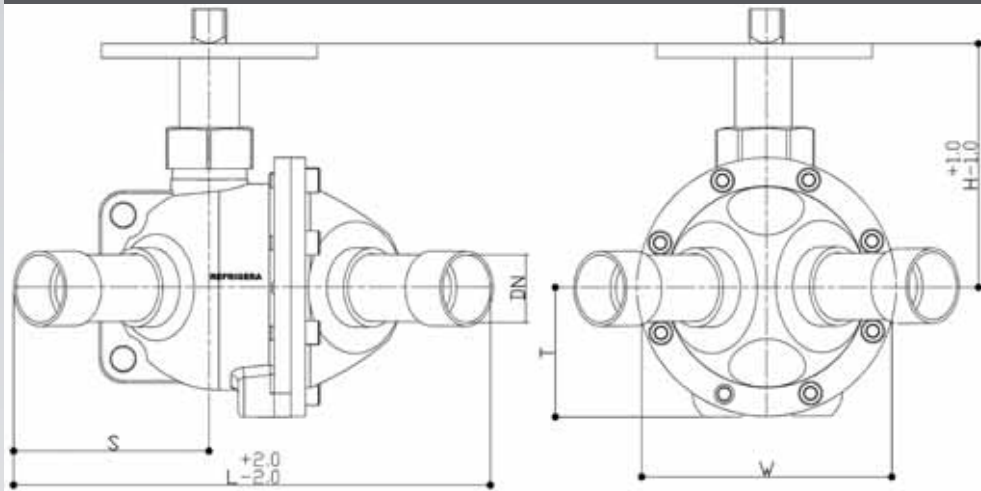
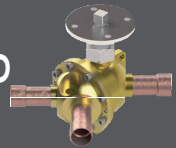



| Code | Connections Size According to ASME/ANSI B36.10 | Weight | Lenght | Lenght | Height | Height | Wide | Kvs | P.E.D. |
|----------------|--|--------|--------|--------|--------|--------|--------|----------------|---------------|
| REF | DN | (g) | S (mm) | L (mm) | T (mm) | H (mm) | W (mm) | ΔP:1bar (m³/h) | Group2 fluids |
| REF4.0.022.3.P | 22 | - | - | - | - | - | - | 12,5 | Art.3.3 |
| REF4.0.028.1.P | 28 | - | - | - | - | - | - | 12,5 | Art.3.3 |
| REF4.0.028.1.P | 1-1/8" | - | - | - | - | - | - | 12,5 | Art.3.3 |





THE IMAGE SHOWS: 4Way Reversing B.V. mounting CuFe2P connections suitable for High Pressure

 Our Check Valves can be mounted in every position and offer the best performance with reduced pressure drops. The CuFe2P alloy connections allow, in addition the brazing through silver alloys without any restriction. Valves are fitted with special seals suitable for R744.

 Le nostre valvole di ritegno possono essere montate in qualunque posizione e offrono il migliore fattore di flusso con le minime perdite di carico. I tronchetti in lega CuFe2P permettono, inoltre, il normale accoppiamento agli impianti tramite brasatura attraverso le consuete leghe d'argento. Le valvole sono dotate di guarnizioni speciali idonee per R744.

 Unsere Rückschlagventile können in jeder Stellung montiert werden und bieten den besten Durchflussfaktor bei niedrigsten Druckverlusten. Mit den Stutzen aus der Legierung CuFe2P kann man auch den normalen Anschluss an die Anlagen durch Löten mit den üblichen Silberlegierungen herstellen. Die Ventile sind mit speziellen, für R744 geeignete Dichtungen.

 Nos vannes à clapets peuvent être montées dans toutes les positions et offrir la meilleure performance avec une pression réduite. L'alliage CuFe2P permet des connexions avec les alliages d'argent pour braser, sans aucune restriction. Les vannes sont équipées de joints spéciaux appropriés pour R744.

 Nuestras válvulas de retención pueden ser montadas en cualquier posición y ofrecen el mejor factor de flujo con la mínimas pérdida de carga. Los troncos fusionados CuFe2P permiten, además el normal acoplamiento a las instalaciones por medio de soldadura a través de las habituales aleaciones de plata. Las válvulas están dotadas de guarniciones especiales idóneas para R744.

 As nossas válvulas de retenção podem ser montadas em qualquer posição e oferecem o melhor fator de fluxo com uma queda mínima de pressão. Os soquetes realizados em liga CuFe2P, também permitem o normal acoplamento com as instalações mediante brasagem com as habituais ligas de prata. As válvulas possuem vedações especiais apropriadas para R744.

 弊社チェック・バルブは、あらゆるポジションでマウントすることができ、減少されたプレッシャー・ドロップで、最高のパフォーマンスを提供することができます。このCuFe2Pアロイ・コネクションはさらに、いかなる制限もなしに、シルバー・アロイをブレージング・スルーすることを可能にします。バルブは、R744に適した特別なシールによってフィットされます。

 Наши обратные клапаны могут монтироваться в любом положении и обеспечивают лучший коэффициент потока при наименьших потерях давления. Потрубки из CuFe2P позволяют соединение с оборудованием через пайку серебряным сплавом. Клапаны оснащены специальными уплотнениями для R744.

transcritical R744 Check Valve CuFe2P

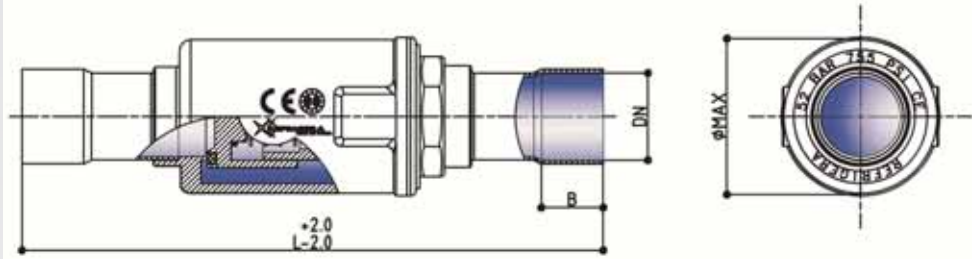
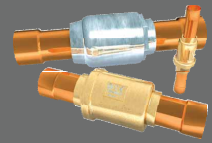



| Code | Connection | Weight | ODS | B | Length | Ø Max | P.E.D. |
|--------------------|-------------|--------|--------|--------|--------------------------------|--------|---------------|
| REF | DN | (g) | Ø (mm) | B (mm) | L (mm) | W (mm) | Group2 fluids |
| REF3.1.N.006.1.120 | 6mm | 88 | 6,1 | 7 | 107 | 24 | Art.3.3 |
| REF3.1.N.006.2.120 | 1/4" | 88 | 6,4 | 7 | 107 | 24 | Art.3.3 |
| REF3.1.N.010.K65 | 10mm | 96 | 10,2 | 9 | 112 | 24 | Art.3.3 |
| REF3.1.N.038.K65 | 3/8" | 96 | 9,7 | 9 | 112 | 24 | Art.3.3 |
| REF3.1.N.012.K65 | 12mm | 100 | 10 | 12 | 139 | 24 | Art.3.3 |
| REF3.1.N.0127.K65 | 1/2" | 100 | 12,8 | 12 | 139 | 37 | Art.3.3 |
| REF3.1.N.015.K65 | 15mm | 280 | 15,2 | 12 | 148 | 37 | Art.3.3 |
| REF3.1.N.016.K65 | 16mm 5/8" | 280 | 16,2 | 14 | 148 | 37 | Art.3.3 |
| REF3.1.N.018.K65 | 18mm | 305 | 18,2 | 14 | 148 | 37 | Art.3.3 |
| REF3.1.N.034.K65 | 3/4" | 305 | 19,3 | 14 | 148 | 37 | Art.3.3 |
| REF3.1.N.022.K65 | 22mm 7/8" | 345 | 22,3 | 17 | 185 | 37 | Art.3.3 |
| REF3.1.N.028.K65 | 28mm | 1100 | 28,2 | 20 | 185 | 60 | Art.3.3 |
| REF3.1.N.118.K65 | 1-1/8" | 1100 | 28,8 | 20 | 185 | 60 | Art.3.3 |
| REF3.1.N.035.K65 | 35mm 1-3/8" | 1736 | 35,2 | 25 | 205 | 70 | Class I |
| REF3.1.N.042.K65 | 42mm | 2560 | 42,2 | 28 | 240 | 80 | Class I |
| REF3.1.N.158.K65 | 1-5/8" | 2580 | 41,5 | 28 | 240 = 0,1 bar = 0,24 bar | 80 | Class I |





THE IMAGE SHOWS: High pressure One Way Valve

 Our bi-flow system allows the mounting of the valve without taking into consideration the direction of the flow. The small equalization hole on the sphere will allow the valve to support the gas pressure without stressing other components. Special executions: flare-flare or sweat-flare valves are available.

 Il brevettato sistema bidirezionale permette di montare la valvola indipendentemente dalla direzione del flusso. Il piccolo foro sulla sfera fa sì che la valvola possa sopportare la pressione del gas senza sollecitare i seggi di tenuta. Si eseguono valvole in esecuzioni speciali filettate-filettate oppure filettate-a saldare.

 Das patentierte Zweigewegsystem ermöglicht die Montage des Ventils unabhängig von der Strömungsrichtung. Die kleine Bohrung auf der Kugel sorgt dafür, dass das Ventil den Gasdruck aushält ohne die Dichtungssitze zu belasten. Gefertigt werden Ventile in Sonderanfertigungen, wie gebördelt oder gebördelt zum Lötten.

 Notre système bi-directionnel permet d'installer la vanne sans se préoccuper de la direction du flux. Le petit trou permet à la vanne de supporter la pression du gaz utilisé sans trop solliciter les autres composants. Exécutions spéciales flare ou sweat-flare disponibles.

 El sistema bidireccional patentado permite montar la válvula independientemente de la dirección del flujo. El pequeño orificio sobre la esfera hace que la válvula pueda soportar la presión del gas sin presionar los asientos de contención.

 O sistema bidireccional patentado permite de montar a válvula independientemente da direção do fluxo. O pequeno orificio sobre a esfera faz com a válvula possa suportar a pressão do gás sem forçar as sedes de vedação. Produzimos válvulas com funcionamentos especiais tais como, de rosca-rosqueadas ou de rosca-para solda.

 弊社バイ・フロー・システムはフローの方向を考慮に入れないバルブのマウンティングを可能とします。スフィア上の小さいコライゼーション・ホールにより、バルブは、他のコンポーネントをストレスさせずにガス・プレッシャーをサポートすることが可能です。特別生産:フレア・フレア、もしくはスウェット・フレア・バルブが入手可能です。

 Наша двунаправленная система позволяет монтировать клапан без учёта направления потока. Небольшое отверстие на шаре позволяет клапану выдерживать давление газа без нагрузки на остальной материал. Имеются винтовые клапаны и пайка-винтовые клапаны.

transcritical R744 ODS-NPT Ball Valve CuFe2P

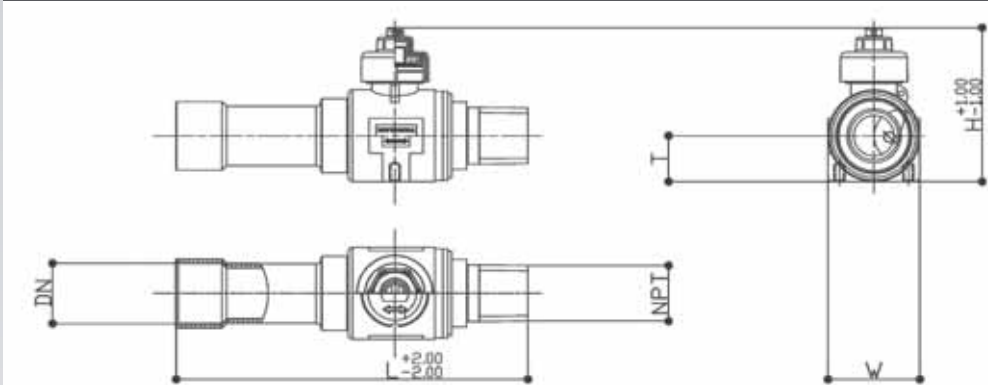
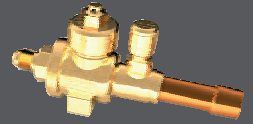



| Code | Connection | Weight | Sphere passage | Length | Height | Wide | IN | Kv | WTemp | P.E.D. |
|----------------------|------------|--------|----------------|--------|--------|--------|------|----------------|-----------|---------------|
| REF | ODS | (g) | Ø (mm) | L (mm) | H (mm) | W (mm) | NPT | ΔP:1bar (m³/h) | °C | Group2 fluids |
| REF1.1.N.P12.015.K65 | 15mm | 290 | 15 | 115 | 56 | 33 | 1/2" | 13 | | Art.3.3 |
| REF1.1.N.P12.016.K65 | 16mm | 290 | 15 | 115 | 56 | 33 | 1/2" | 13 | | Art.3.3 |
| REF1.1.N.P12.018.K65 | 18mm | 290 | 15 | 115 | 56 | 33 | 1/2" | 13 | -40/ +150 | Art.3.3 |
| REF1.1.N.P12.018.K65 | 3/4" | 290 | 15 | 115 | 56 | 33 | 1/2" | 13 | | Art.3.3 |
| REF1.1.N.P01.022.K65 | 22mm | 360 | 19 | 155 | 83 | 45 | 1" | 24 | | Art.3.3 |





THE IMAGE SHOWS: CuFe2P High Pressure ODS / NPT ball valve useful to be easy and safe coupled with receivers through NPT connection

 The sight port, entirely turned from a single stainless steel bar, ensures endurance and lasting in the most extreme operating conditions. Thermally toughened Borosilicate glass, according to DIN 7080 maintain high resistance, temperature tolerance and high-grade transparency properties. The CuFe2P alloy connections allow, in addition the brazing through silver alloys without any restriction.

 L'indicatore di liquido, tornito integralmente da barra d'acciaio inox, assicura doti di resistenza ed inalterabilità nelle più estreme condizioni di esercizio. L'ispezione in vetro temperato al Borosilicato DIN 7080, non teme l'alta pressione, gli sbalzi termici e possiede superiori doti di trasparenza. I tronchetti in lega CuFe2P permettono, inoltre, il normale accoppiamento agli impianti tramite brasatura attraverso le consuete leghe d'argento.

 Die ganz aus einer Edelstahlhülse gedrehte Flüssigkeitsanzeige garantiert auch unter extremsten Betriebsbedingungen Resistenz und Beständigkeit. Das Schauglas aus gehärtetem Borosilikatglas DIN 7080 widersteht Hochdruck und Temperaturschwankungen und bietet eine höhere Transparenz. Mit den Stutzen aus der Legierung CuFe2P kann man auch den normalen Anschluss an die Anlagen durch Lötten mit den üblichen Silberlegierungen herstellen.

 Le voyant indicateur de liquide, entièrement fondu dans une unique barre d'acier inoxydable, assure une résistance durable dans les conditions les plus extrêmes. Le verre borosilicate, trempé thermiquement selon la norme DIN 7080, permet de maintenir une forte résistance et tolérance à la température et ses propriétés de transparence en cas de degrés élevés. L'alliage CuFe2P permet des connexions avec les alliages d'argent pour braser, sans aucune restriction.

 El indicador de líquido, torneado integralmente de una barra de acero inoxidable, asegura dotes de resistencia e inalterabilidad en las más extremas condiciones de ejercicio. El vidrio de borosilicato DIN 7080 templado térmicamente, no teme la alta presión, los cambios de temperatura y posee grandes dotes de transparencia. Los troncos en aleación CuFe2P permiten, además el normal acoplamiento a las instalaciones por medio de soldadura a través de las habituales aleaciones de plata.

 O indicador de líquido, fabricado integralmente em uma barra de aço inox, assegura maior resistência e inalterabilidade em condições extremas de exercício. O visor em vidro temperado ao Borosilicato DIN 7080, é resistente à alta pressão, às variações térmicas e possui qualidades de transparência superior. Os soquetes realizados em liga CuFe2P, também permitem o normal acoplamento com as instalações mediante brasagem com as habituais ligas de prata.

 シングル・ステンレス・スチール・バーから全体が造出されているこのサイト・ポートは、最も厳しいオペレーティング・コンディション中における、耐久性と継続性を確実にします。DIN 7080に従って熱加工的に強化されたボロシリケート・ガラスは、ハイ・レジスタンスで、耐温度性があり、そしてハイ・グレードな透明度プロパティを維持します。このCuFe2Pアロイ・コネクションはさらに、いかなる制限もなしに、シルバー・アロイをブレイジング・スルーすることを可能にします。

 Индикатор жидкости, полностью превратился из одной штанги из нержавеющей стали, обеспечивает выносливость и прочность в самых экстремальных условиях эксплуатации. Термически закаленное боросиликатного стекла, в соответствии с DIN 7080 поддерживают высокую стойкость, температуру термичности и полноценные свойства прозрачности. Потрубки из CuFe2P позволяют соединение с оборудованием через пайку серебряным сплавом.

transcritical R744 Liquid Indicator CuFe2P

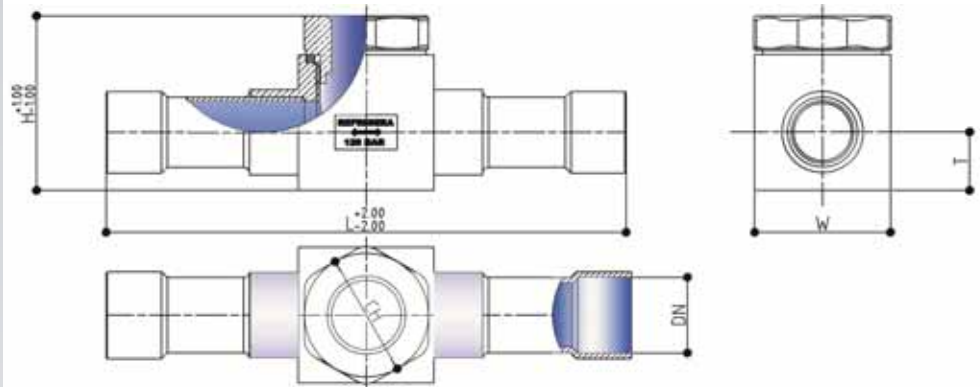
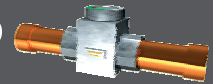

| Code | Connection | Weight | ODS | T | Length | CH | Kv | WTemp | P.E.D. |
|---------------------|------------|--------|--------|--------|--------|---------|----------------|-----------|---------------|
| REF | DN | (g) | Ø (mm) | T (mm) | L (mm) | CH (mm) | ΔP:1bar (m3/h) | °C | Group2 fluids |
| REF60.61.07.010.K65 | 10mm | 325 | 10,2 | 15 | 110 | 32 | 2,4 | | Art.3.3 |
| REF60.61.07.038.K65 | 3/8" | 325 | 9,7 | 15 | 110 | 32 | 2,4 | | Art.3.3 |
| REF60.61.07.012.K65 | 12mm | 330 | 10 | 15 | 118 | 32 | 2,7 | | Art.3.3 |
| REF60.61.07.127.K65 | 1/2" | 330 | 12,8 | 15 | 118 | 32 | 2,7 | | Art.3.3 |
| REF60.61.07.015.K65 | 15mm | 340 | 15,2 | 15 | 128 | 32 | 12,5 | | Art.3.3 |
| REF60.61.07.016.K65 | 16mm 5/8" | 345 | 16,2 | 15 | 128 | 32 | 13 | | Art.3.3 |
| REF60.61.07.018.K65 | 18mm | 350 | 18,2 | 15 | 148 | 32 | 14 | -40/ +150 | Art.3.3 |
| REF60.61.07.034.K65 | 3/4" | 350 | 19,3 | 14 | 148 | 32 | 14 | | Art.3.3 |
| REF60.61.07.022.K65 | 22mm 7/8" | 365 | 22,3 | 17 | 154 | 32 | 24 | | Art.3.3 |
| REF60.61.07.028.K65 | 28mm | 505 | 28,2 | 18 | 166 | 32 | 40 | | Art.3.3 |
| REF60.61.07.118.K65 | 1-1/8" | 505 | 28,8 | 18 | 166 | 32 | 40 | | Art.3.3 |
| REF60.61.07.035.K65 | 35mm | 705 | 35,2 | 20 | 170 | 32 | 67,3 | | Art.3.3 |



THE IMAGE SHOWS: High Pressure Liquid Indicator mounting CuFe2P ODS connections

Moisture contained in the fluid (p.p.m.)

Colour Refrigerant fluid

R744

Green <50

Yellow >50

 Completely made of CuFe2P alloy, REFRIGERA fittings have the peculiar value to be provided with ODS connections that assure easy torch-brazing with the normal Ag filler metals.

 Interamente realizzati in lega CuFe2P, i fittings REFRIGERA hanno la peculiare caratteristica di essere provvisti di connessioni ODS a saldare, permettendo il perfetto accoppiamento mediante brasatura a cannelo attraverso normali leghe d'argento.

 Ganz aus der Legierung CuFe2P hergestellt, verfügen die Fittings REFRIGERA über das besondere Merkmal der zu schweißenden ODS-Verbindungen und ermöglichen einen perfekten Anschluss durch Hartlöten mit normalen Silberlegierungen.

 Entièrement réalisés en alliage d'CuFe2P, les raccords REFRIGERA ont la valeur particulière d'être fournis avec les connexions ODS à souder, qui assurent facilement le brasage avec tous les métaux d'apport Argent.

 Completamente realizados en aleación CuFe2P, los filtros REFRIGERA poseen la particular característica de estar provistos de conexiones ODS soldadas, permitiendo el perfecto acoplamiento mediante soldadura soplete a través de normales aleaciones en plata.

 Inteiramente realizados em liga CuFe2P, os acessórios REFRIGERA apresentam uma característica peculiar, pois dispõem de conexões ODS para solda, permitindo o acoplamento perfeito mediante brasagem com maçarico e as habituais ligas de prata.

 レフリジェラ・フィッティングは完全にCuFe2Pアロイによって作られており、提供すべき優れたバリュウを保持しています。これらには、通常のAgフィラー・メタルによる簡潔なトーチ・ブレイジングを確実にする、ODSコネクションが伴います。

 Сделанные полностью из сплава CuFe2P, фитинги REFRIGERA имеют соединения ODS, которые позволяют пайку сварочной горелкой через серебряные сплавы.

transcritical R744 Coupling CuFe2P

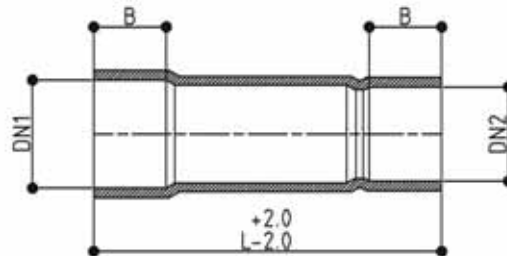
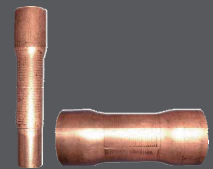

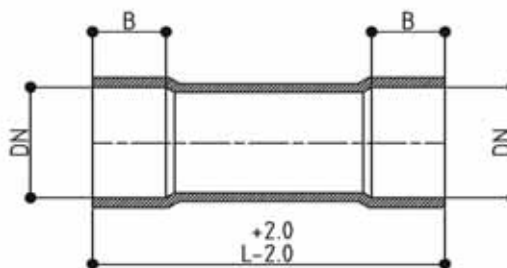

| Code | ODS | ODS | Weight | Length | B | P.E.D. |
|------------------|--------|--------|--------|--------|--------|---------------|
| REF | DN | DN | (g) | L (mm) | B (mm) | Group2 fluids |
| REF92.012.010.FF | 12mm | 10mm | 20 | 68 | 15 | Art.3.3 |
| REF92.127.038.FF | 1/2" | 3/8" | 20 | 68 | 15 | Art.3.3 |
| REF92.016.012.FF | 16mm | 12mm | 35 | 70 | 15 | Art.3.3 |
| REF92.058.127.FF | 5/8" | 1/2" | 35 | 71 | 15 | Art.3.3 |
| REF92.018.016.FF | 18mm | 16mm | 40 | 72 | 15 | Art.3.3 |
| REF92.034.058.FF | 3/4" | 5/8"mm | 40 | 72 | 15 | Art.3.3 |
| REF92.022.018.FF | 22mm | 18mm | 65 | 72 | 15 | Art.3.3 |
| REF92.078.034.FF | 7/8" | 3/4" | 65 | 72 | 15 | Art.3.3 |
| REF92.028.022.FF | 28mm | 22mm | 115 | 75 | 16 | Art.3.3 |
| REF92.118.078.FF | 1-1/8" | 7/8" | 115 | 75 | 16 | Art.3.3 |
| REF92.035.028.FF | 35mm | 28mm | 235 | 100 | 20 | Art.3.3 |
| REF92.138.118.FF | 1-3/8" | 1-1/8" | 235 | 100 | 20 | Art.3.3 |
| REF92.042.035.FF | 42mm | 35mm | 360 | 105 | 20 | Art.3.3 |
| REF92.158.138.FF | 1-5/8" | 1-5/8" | 360 | 105 | 20 | Art.3.3 |





| Code | ODS | Connection | Weight | Length | High | B | P.E.D. |
|------------------|-----------|------------|--------|--------|--------|--------|---------------|
| REF | DN | Ø | (g) | L (mm) | H (mm) | B (mm) | Group2 fluids |
| REF93.010.010.FF | 10mm | 10,2 | 12 | 58 | 36 | 10 | Art.3.3 |
| REF93.038.038.FF | 3/8" | 9,64 | 12 | 58 | 36 | 10 | Art.3.3 |
| REF93.012.012.FF | 12mm | 12,2 | 25 | 68 | 41 | 15 | Art.3.3 |
| REF93.127.127.FF | 1/2" | 12,81 | 25 | 68 | 41 | 15 | Art.3.3 |
| REF93.016.016.FF | 16mm 5/8" | 16,1 | 40 | 68 | 43 | 15 | Art.3.3 |
| REF93.018.018.FF | 18mm | 18,2 | 45 | 75 | 45 | 15 | Art.3.3 |
| REF93.034.034.FF | 3/4" | 19,17 | 45 | 75 | 45 | 15 | Art.3.3 |
| REF93.022.022.FF | 22mm 7/8" | 22,4 | 70 | 75 | 48 | 15 | Art.3.3 |
| REF93.028.028.FF | 28mm | 28,2 | 120 | 75 | 60 | 15 | Art.3.3 |
| REF93.118.118.FF | 1-1/8" | 28,8 | 120 | 75 | 60 | 15 | Art.3.3 |
| REF93.035.035.FF | 35mm | 35,1 | 250 | 100 | 70 | 20 | Art.3.3 |
| REF93.042.042.FF | 42mm | 42,2 | 330 | 105 | 102 | 20 | Art.3.3 |
| REF93.158.158.FF | 1-5/8" | 41,4 | 330 | 105 | 102 | 20 | Art.3.3 |

 Completely made of CuFe2P alloy, REFRIGERA fittings have the peculiar value to be provided with ODS connections that assure easy torch-brazing with the normal Ag filler metals.

 Interamente realizzati in lega CuFe2P, i fittings REFRIGERA hanno la peculiare caratteristica di essere provvisti di connessioni ODS a saldare, permettendo il perfetto accoppiamento mediante brasatura a cannello attraverso normali leghe d'argento.

 Ganz aus der Legierung CuFe2P hergestellt, verfügen die Fittings REFRIGERA über das besondere Merkmal der zu schweißenden ODS-Verbindungen und ermöglichen einen perfekten Anschluss durch Hartlöten mit normalen Silberlegierungen.

 Entièrement réalisés en alliage d'CuFe2P, les raccords REFRIGERA ont la valeur particulière d'être fournis avec les connexions ODS à souder, qui assurent facilement le brasage avec tous les métaux d'apport Argent.

 Completamente realizados en aleación CuFe2P, los filtros REFRIGERA poseen la particular característica de estar provistos de conexiones ODS soldadas, permitiendo el perfecto acoplamiento mediante soldadura soplete a través de normales aleaciones en plata.

 Inteiramente realizados em liga CuFe2P, os acessórios REFRIGERA apresentam uma característica peculiar, pois dispõem de conexões ODS para solda, permitindo o acoplamento perfeito mediante brasagem com maçarico e as habituais ligas de prata.

 レフリジェラ・フィッティングは完全にCuFe2Pアロイによって作られており、提供すべき優れたバリューを保持しています。これらには、通常のAgフィラー・メタルによる簡潔なトーチ・ブレージングを確実にする、ODSコネクションが伴います。

 Сделанные полностью из сплава CuFe2P, фитинги REFRIGERA имеют соединения ODS, которые позволяют пайку сварочной горелкой через серебряные сплавы.

transcritical R744 Bend CuFe2P

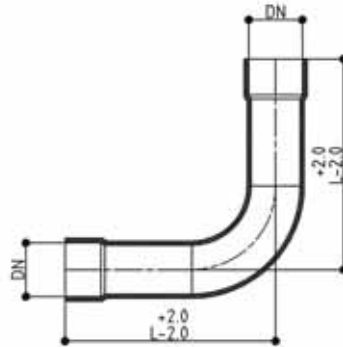

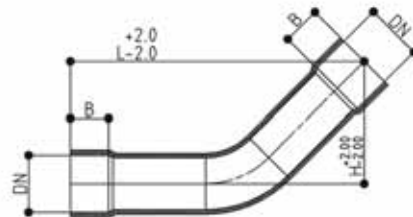

| Code | ODS | Connection | Weight | Length | B | P.E.D. |
|------------------|-----------|------------|--------|--------|--------|---------------|
| REF | DN | Ø | (g) | L (mm) | B (mm) | Group2 fluids |
| REF91.010.010.FF | 10mm | 10,2 | 25 | 60 | 15 | Art.3.3 |
| REF91.038.038.FF | 3/8" | 9,64 | 25 | 60 | 15 | Art.3.3 |
| REF91.012.012.FF | 12mm | 12,2 | 40 | 68 | 15 | Art.3.3 |
| REF91.127.127.FF | 1/2" | 12,81 | 40 | 68 | 15 | Art.3.3 |
| REF91.016.016.FF | 16mm 5/8" | 16,1 | 75 | 75 | 15 | Art.3.3 |
| REF91.018.018.FF | 18mm | 18,2 | 80 | 78 | 15 | Art.3.3 |
| REF91.034.034.FF | 3/4" | 19,17 | 80 | 78 | 15 | Art.3.3 |
| REF91.022.022.FF | 22mm 7/8" | 22,4 | 145 | 88 | 15 | Art.3.3 |
| REF91.028.028.FF | 28mm | 28,2 | 290 | 108 | 16 | Art.3.3 |
| REF91.118.118.FF | 1-1/8" | 28,8 | 290 | 108 | 16 | Art.3.3 |
| REF91.035.035.FF | 35mm | 35,1 | 590 | 140 | 20 | Art.3.3 |
| REF91.042.042.FF | 42mm | 42,2 | 1150 | 182 | 20 | Art.3.3 |
| REF91.158.158.FF | 1-5/8" | 41,4 | 1150 | 182 | 20 | Art.3.3 |





| Code | ODS | Connection | Weight | Length | High | B | P.E.D. |
|------------------|-----------|------------|--------|--------|--------|--------|---------------|
| REF | DN | Ø | (g) | L (mm) | H (mm) | B (mm) | Group2 fluids |
| REF94.010.010.FF | 10mm | 10,2 | 25 | 87 | 36 | 10 | Art.3.3 |
| REF94.038.038.FF | 3/8" | 9,64 | 25 | 87 | 36 | 10 | Art.3.3 |
| REF94.012.012.FF | 12mm | 12,2 | 40 | 98 | 41 | 15 | Art.3.3 |
| REF94.127.127.FF | 1/2" | 12,81 | 40 | 98 | 41 | 15 | Art.3.3 |
| REF94.016.016.FF | 16mm 5/8" | 16,1 | 75 | 104 | 43 | 15 | Art.3.3 |
| REF94.018.018.FF | 18mm | 18,2 | 80 | 109 | 45 | 15 | Art.3.3 |
| REF94.034.034.FF | 3/4" | 19,17 | 80 | 109 | 45 | 15 | Art.3.3 |
| REF94.022.022.FF | 22mm 7/8" | 22,4 | 145 | 115 | 48 | 15 | Art.3.3 |
| REF94.028.028.FF | 28mm | 28,2 | 290 | 144 | 60 | 16 | Art.3.3 |
| REF94.118.118.FF | 1-1/8" | 28,8 | 290 | 144 | 60 | 16 | Art.3.3 |
| REF94.035.035.FF | 35mm | 35,1 | 590 | 169 | 70 | 20 | Art.3.3 |
| REF94.042.042.FF | 42mm | 42,2 | 1150 | 246 | 102 | 20 | Art.3.3 |
| REF94.158.158.FF | 1-5/8" | 41,4 | 1150 | 246 | 102 | 20 | Art.3.3 |

 Completely made of CuFe2P alloy, REFRIGERA fittings have the peculiar value to be provided with ODS connections that assure easy torch-brazing with the normal Ag filler metals.

 Interamente realizzati in lega CuFe2P, i fittings REFRIGERA hanno la peculiare caratteristica di essere provvisti di connessioni ODS a saldare, permettendo il perfetto accoppiamento mediante brasatura a cannello attraverso normali leghe d'argento.

 Ganz aus der Legierung CuFe2P hergestellt, verfügen die Fittings REFRIGERA über das besondere Merkmal der zu schweißenden ODS-Verbindungen und ermöglichen einen perfekten Anschluss durch Hartlötten mit normalen Silberlegierungen.

 Entièrement réalisés en alliage d'CuFe2P, les raccords REFRIGERA ont la valeur particulière d'être fournis avec les connexions ODS à souder, qui assurent facilement le brasage avec tous les métaux d'apport Argent.

 Completamente realizados en aleación CuFe2P, los filtros REFRIGERA poseen la particular característica de estar provistos de conexiones ODS soldadas, permitiendo el perfecto acoplamiento mediante soldadura soplete a través de normales aleaciones en plata.

 Inteiramente realizados em liga CuFe2P, os acessórios REFRIGERA apresentam uma característica peculiar, pois dispõem de conexões ODS para solda, permitindo o acoplamento perfeito mediante brasagem com maçarico e as habituais ligas de prata.

 レフリジェラ・フィッティングは完全にCuFe2Pアロイによって作られており、提供すべき優れたバリューを保持しています。これらには、通常のAgフィラー・メタルによる簡潔なトーチ・ブレージングを確実にする、ODSコネクションが伴います。

 Сделанные полностью из сплава CuFe2P, фитинги REFRIGERA имеют соединения ODS, которые позволяют пайку сварочной горелкой через серебряные сплавы.

transcritical R744 Tee Joint CuFe2P

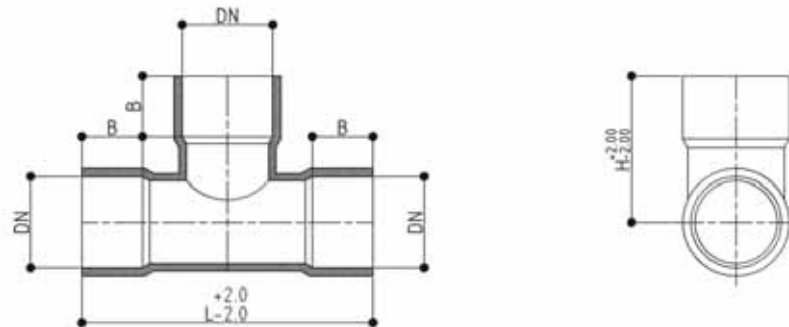



| Code | ODS | Connection | Height | Length | B | P.E.D. |
|----------------------|--------|------------|--------|--------|--------|---------------|
| REF | DN | Ø | H(mm) | L (mm) | B (mm) | Group2 fluids |
| REF96.038.038.038.FF | 3/8" | 9,64 | 15 | 30 | 7 | Art.3.3 |
| REF96.127.127.127.FF | 1/2" | 12,81 | 20 | 35 | 12 | Art.3.3 |
| REF96.058.058.058.FF | 5/8" | 16,1 | 40 | 68 | 15 | Art.3.3 |
| REF96.034.034.034.FF | 3/4" | 19,17 | 25 | 50 | 15 | Art.3.3 |
| REF96.078.078.078.FF | 7/8" | 22,4 | 35 | 60 | 15 | Art.3.3 |
| REF96.118.118.118.FF | 1-1/8" | 28,8 | 40 | 70 | 15 | Art.3.3 |
| REF96.138.138.138.FF | 1-3/8" | 35,1 | 80 | 78 | 15 | Art.3.3 |
| REF96.158.158.158.FF | 1-5/8" | 41,4 | 50 | 95 | 20 | Art.3.3 |





| Code | ODS Connection | | Length | B | P.E.D. |
|------------------|----------------|--------|--------|--------|---------------|
| REF | mm | inch | L (mm) | B (mm) | Group2 fluids |
| REF92.038.010.MF | 10 | 3/8" | 60 | 15 | Art.3.3 |
| REF92.127.012.MF | 12 | 1/2" | 60 | 15 | Art.3.3 |
| REF92.034.016.MF | 16 | 3/4" | 68 | 15 | Art.3.3 |
| REF92.118.028.MF | 28 | 1-1/8" | 68 | 15 | Art.3.3 |
| REF92.158.042.MF | 42 | 1-5/8" | 75 | 15 | Art.3.3 |

 *Insulating material in synthetic rubber - based on elastomeric foam - available upon request in class 1 and M1, for all valves sizes.*

 *Guaina isolante in elastomero espanso disponibile su richiesta in classe 1 e M1 per tutte le valvole.*

 *Für alle Ventile gibt es auf Anfrage eine isolierende Elastomer-Ummantelung der Klasse 1 und M1.*

 *La gaine élastomère d'isolation en mousse de polyéthylène réticulée, est disponible en classes 1 et M1 sur demande, pour toutes les vannes Réfrigera.*

 *Vaina aislante en elastómero expandido disponible a pedido en clase 1 y M1 para todas las válvulas.*

 *Revestimento isolante em elastómero disponível sob pedido, classes 1 e M1, para todas as válvulas.*

 *エラストメリック・フォームを基にした、シンセティック・ラバーの内装材が、ご希望により、入手可能です。クラス1とM1のすべてのバルブ・サイズに適合します。*

 *Оболочка эластомерных пенной изоляции из сшитого полиэтилена. Можно получить по запросу в Классе 1 и M1 для всех клапанов.*

Ball Valves Insulating Sleeve

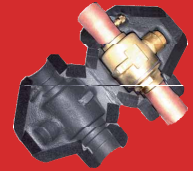



| Code | Type | Size |
|-------------------|---|------------------------------|
| REF | Description | ODS |
| REF90.VS.06.125.Z | 2W BallValve | 6mm—1/4"—10mm—3/8"—12mm—1/2" |
| REF90.VS.06.125.A | 2W BallValve with Schraeder access port | 6mm—1/4"—10mm—3/8"—12mm—1/2" |
| REF90.V3.06.125.Z | 3W BallValve | 15mm—16mm—5/8"—18mm—3/4" |
| REF90.V3.06.125.A | 3W BallValve with Schraeder access port | 15mm—16mm—5/8"—18mm—3/4" |
| REF90.VS.22.118 | 2W BallValve | 22mm—7/8"—28mm—1-1/8" |
| REF90.VS.35.138 | 2W BallValve | 35mm—1-3/8" |
| REF90.VS.42.158 | 2W BallValve | 42mm—1-5/8" |
| REF90.VS.54.218 | 2W BallValve | 54mm—2-1/8" |
| REF90.VS.64.258 | 2W BallValve | 64mm—67mm—2-5/8" |
| REF90.VS.76.080 | 2W BallValve | 76mm—3"—80mm—3-1/8" |

 Mounting Kit made of AISI 304 Stainless Steel; through ISO 5211 standard flange, allows to fit special Refrigera™ valves with all the actuators on the market. The lever shaft is mounted in explosion-proof configuration and is hermetic airtight designed.

 Il kit di montaggio è realizzato in acciaio inox AISI 304 e permette l'accoppiamento - mediante flangia ISO 5211- di valvole Refrigera™ appositamente predisposte con tutti gli attuatori attualmente presenti sul mercato. Il perno di manovra viene montato in configurazione antisceppio ed è progettato a tenuta ermetica mediante O-Ring R744 compatibili.

 Der Montagesatz ist aus Edelstahl AISI 304 hergestellt und erlaubt den Anschluss - mit Flansch ISO 5211- der eigens hierfür vorgefertigten Ventile Refrigera™ an alle momentan im Handel befindlichen Antriebe. Der Schaltzapfen wird in berstssicherer Ausführung montiert und bietet mit dem O-Ring, der mit R744 Kompatibel ist, eine hermetische Dichtung.

 Le kit est fabriqué en acier inoxydable AISI 304 et permet à la paire - avec bride ISO 5211 - des vannes Refrigera spécialement fabriquées, pour tous les acteurs sur le marché aujourd'hui. Le levier est monté dans une configuration anti explosion, conçu hermétiquement avec le joint O-Ring R744, compatible pour le R744.

 El kit de montaje está realizado en acero inoxidable AISI 304 y permite el acoplamiento - mediante brida ISO 5211 - de Válvulas REFRIGERA expresamente predisuestas con todos los actuadores actualmente presentes en el mercado. El perno de maniobra viene montado en configuración antiestallido y está proyectado para contención hermética mediante compatibilidad O-Ring R744.

 O kit de montagem é realizado em aço inoxidável AISI 304 e permite o acoplamento (com flange ISO 5211) das válvulas Refrigera™ especialmente realizadas para os atuadores disponíveis atualmente no comércio. O pivô é montado na configuração à prova de explosão e lacrado hermeticamente com anéis O-Ring R744 compatíveis.

 AISI 304

ステンレス・スチールで作られたマウンティング・キット。ISO 5211水準のフランジを通じ、特別レフリジェラ™バルブを、市場に存在するすべてのアクチュエーターにフィットさせることを可能にします。レバー・シャフトが爆発防止の設定でマウントされており、完封エアタイト設計されています。

 Комплект выполнен из нержавеющей стали AISI 304 и позволяет соединению, через фланец ISO 5211, клапанов Refrigera™, специально изготовленных, со всеми приводами рынка. Рычаг вала осуществляет взрывобезопасную функцию и герметично запечатан с подходящими O-RING R744.

Flanged Connection KIT

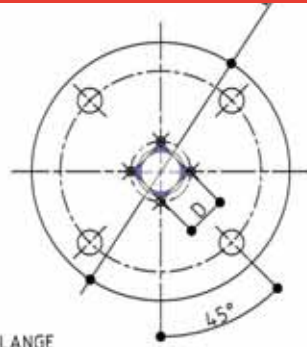

DN 3337 FLANGE

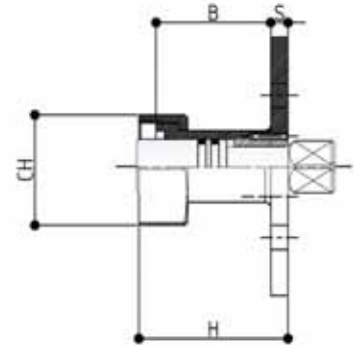

| Code | Connection | D | Weight | Diameter | Length | Height | Thick | P.E.D. |
|-------------------|-----------------|--------|--------|----------|--------|--------|--------|---------------|
| REF | FLANGE ISO 5211 | D (mm) | (g) | Ø(mm) | B (mm) | H (mm) | S (mm) | Group2 fluids |
| REFKIT N-A/B | F03 | 9 | 250 | 50 | 62 | 68 | 6 | Art.3.3 |
| REFKIT N-C/D | F03 | 9 | 220 | 50 | 30 | 36 | 6 | Art.3.3 |
| REFKIT N-C/D SPEC | F03 | 14 | 220 | 50 | 30 | 36 | 6 | Art.3.3 |
| REFKIT N E/G | F05 / F07 | 14 | 260 | 90 | 40 | 46 | 6 | Art.3.3 |
| REFKIT N F | F05 / F07 | 14 | 620 | 90 | 40 | 46 | 6 | Art.3.3 |
| REFKIT N-H/L | F07 | 17 | 870 | 90 | 46,5 | 57 | 9 | Art.3.3 |

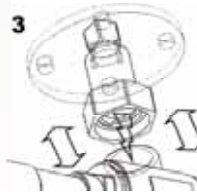
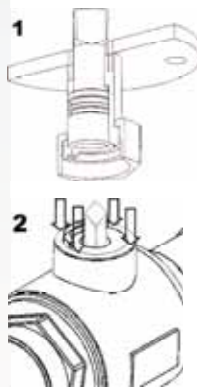

Assembly Kit is supplied pre-assembled with the connection on the valve's stem already inserted. Il Kit di Assemblaggio viene fornito pre-montato, cioè con lo stelo di collegamento al perno della valvola a sfera già inserito

Before start mounting the Kit, put the fiber-composite gasket enclosed in the box on the upper side of the valve, carefully centering it with the stem. Prima di montare il Kit assicurarsi di posizionare la guarnizione in materiale composito fornita nella confezione sotto il cappellotto della valvola, controllandone bene la centratura.

Draw up your Kit to the valve. Start inserting the Kit to the valve's stem, aligning parallel faces. Avvicinare il Kit alla sede del cappellotto e, facendo riferimento alle facce parallele del perno, iniziare ad inserirlo nel Kit.

Continue drawing up your Kit to the valve, centering the stem disregarding the position of the nut. Continuare ad avvicinare il Kit al piano, facendo riferimento, per la centratura, al perno senza agire sul dado filettato.

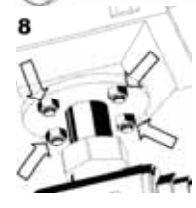
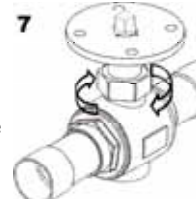
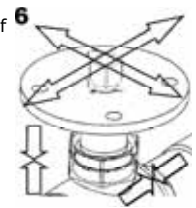
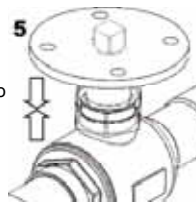

Join the two sides without applying force. Then turn Kit counter-clockwise until it will fit into the valve (you'll hear the characteristic "click" and you'll no more able to rotate kit around the valve. Accoppiare senza forzare le estremità. Ruotare delicatamente in senso antiorario fino ad incastrare il kit alla valvola (dopo il "click" e non sarà più possibile ruotare il Kit rispetto alla valvola).

Check the perfect alignment of the holes and for the stability of the contact. Accertarsi del perfetto allineamento dei fori e della stabilità del kit.

Screw firmly the nut (at least 40Nm torsion strength) without move the upper parts just coupled. Avvitare saldamente il dado alla valvola con una forza di torsione di almeno 40Nm senza toccare la parte superiore.

Assemble kit with actuator screwing firmly the 4 bolts. Inserire l'attuatore ed avvitare i 4 dadi di fissaggio.

CAUTION: DO NOT ROTATE MANOEUVRING ROD BEFORE ASSEMBLING THE ACTUATOR
 IMPORTANTE: NON RUOTARE LO STELO PERIMA DELL'ACCOPIAMENTO CON L'ATTUATORE

 Rotary Electric Actuators useful for the remote opening / closing control, or the choking of the ball valve. They can be connected together with specially crafted Refrigera Valve, using connectivity kit, sold separately.

 Motori per il controllo in remoto dell'apertura / chiusura o per la parzializzazione della valvola a sfera. Utilizzabili congiuntamente alle valvole Refrigera appositamente predisposte, tramite kit di connessione venduto a parte.

 Motoren für die Fernsteuerung der Öffnung/Schließung oder der Drosselung des Kugelventils. Zusammen mit den eigens hierfür vorgerüsteten Ventilen Refrigera verwendbar, der hierfür nötige Anschlussbausatz muss getrennt bezogen werden.

 Les moteurs de controle pour la téléc-commande d'ouverture / fermeture, ou l'enclenchement de la vanne sphérique. Ils peuvent être connectés ensemble avec vanne Refrigera spécialement conçue, en utilisant le kit de connection, vendu séparément.

 Motores para el control remoto de la apertura/cierre o para la parcialización de la válvula a esfera. Utilizables conjuntamente a las válvulas REFRIGERA expresamente predisuestas, por medio del kit de conexión vendido a parte.



 Motores para o controle à distância para a abrir / fechar ou para a parcialização da válvula de esfera. Podem ser utilizados em conjunto com as válvulas Refrigera apropriadamente preparadas, com o kit de conexão vendido separadamente.

 リモートの開口/閉口コントロール、もしくはボール・バルブのチョーキングに便利な、ロータリー・エレクトリック・アクチュエーター。これらは、特別に製造されたレフリジェラ・バルブと一緒にコネクティング・キットを使用することができます。別売りのコネクティブィ・キットをご使用下さい。

 Электрические приводы полезны для дистанционного открытия / закрытия, или удушение шарового крана. Они могут быть соединены вместе со специально разработанными клапанами, используя комплект, который продается отдельно.

Rotary Electrical Actuators



| Code | |  |  | |
|-------------------|--|--|---|----------------------|
| Electrical | Nominal Voltage | AC100...240V, 50/60Hz | AC100...240V, 50/60Hz | |
| | Power supply range | AC85...265V | AC85...265V | |
| | Power Consumption | In operation | 2,5W at nominal Torque | 4W at nominal Torque |
| | | at rest | 0,4 W | 2 W |
| | for wire sizing | 6 VA | 7 VA | |
| Connection | Cable 1m, 3 x 0,75mm ² | Cable 1m, 3 x 0,75mm ² | | |
| Functional | Parallel Connection | Possible | Possible | |
| | Torque (nominal) | 20Nm at nominal V | 40Nm at nominal V | |
| | Manual Override | Gearing Latch disengaged with pushbutton (temporary -permanent) | Gearing Latch disengaged with pushbutton (temporary -permanent) | |
| | Running Time | 90s / 90° | 150s / 90° | |
| | Noise Level | Max. 45dB (A) without valve | Max. 45dB (A) without valve | |
| Safety | Position Indicator | Mechanical, add on | Mechanical, add on | |
| | Protection Class | II - Totally Insulated | II - Totally Insulated | |
| | Degree of Protection | IP54 in any mounting position | IP54 in any mounting position | |
| | ATEX | - | - | |
| | Electro Magnetic Compatibility Directive | CE according to 89/336/EEC | CE according to 89/336/EEC | |
| Dimensions | Low Voltage Directive | CE according to 72/23/EWG | CE according to 72/23/EWG | |
| | Mode of operation | Type1 (to EN 60730-1) | Type1 (to EN 60730-1) | |
| | Rated Impulse Voltage | 4 kV (to EN 60730-1) | 4 kV (to EN 60730-1) | |
| | Control Pollution Degree | 3 (to EN 60730-1) | 3 (to EN 60730-1) | |
| | Ambient Temp. Range | 0...+50°C | 0...+50°C | |
| | Media Temperature | +5...+100° -10°C with stem heating | -20...+100° | |
| | Non-operating Override | -40°C...+80°C | -40°C...+80°C | |
| | Ambient humidity range | 95% r.H. non condensating (to EN607303-1) | 95% r.H. non condensating (to EN607303-1) | |
| | Maintenance | Maintenance Free | Maintenance Free | |
| | Weight | Approx. 1000g | Approx. 1850g | |

Actuators' Selection Table

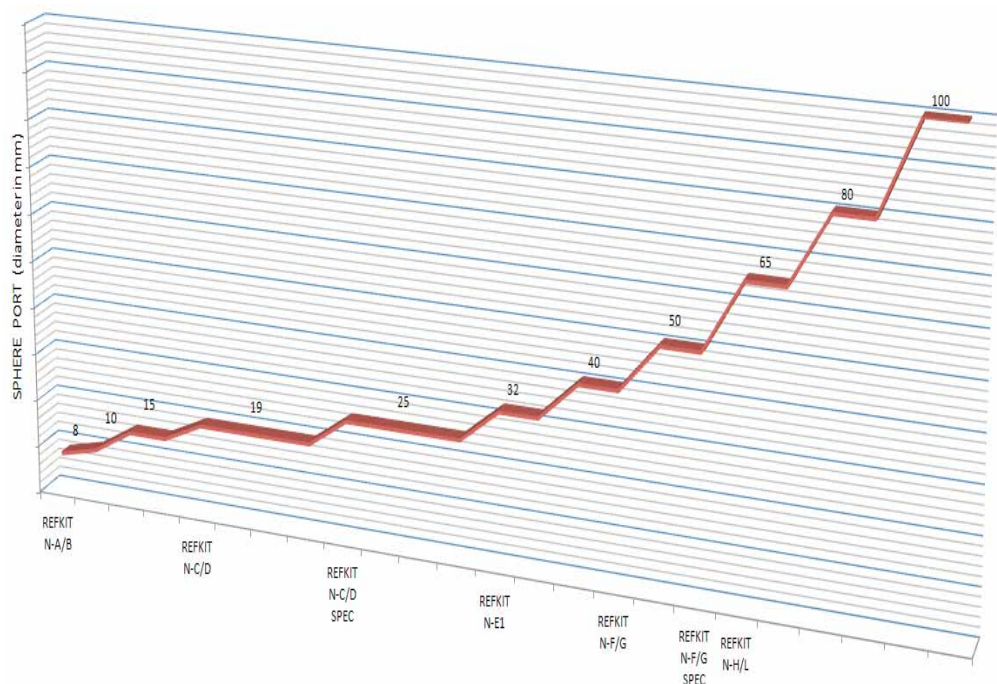

IP67 Protection Electric Actuators



Rotary Electric Actuators useful for the remote opening / closing control, or the choking of the ball valve. They can be connected together with specially crafted Refrigera Valve, using connection kit, sold separately. IP67 Protection.

Motori per il controllo in remoto dell'apertura / chiusura o per la parzializzazione della valvola a sfera. Utilizzabili congiuntamente alle valvole Refrigera appositamente predisposte, tramite kit di connessione venduto a parte. Protezione IP67

Motoren für die Fernsteuerung der Öffnung/Schließung oder der Drosselung des Kugelventils. Zusammen mit den eigens hierfür vorgestellten Ventilen Refrigera verwendbar, der hierfür nötige Anschlussbausatz muss getrennt bezogen werden. Schutzart IP67

Les moteurs de controle pour la télécommande d'ouverture / fermeture, ou l'enclenchement de la vanne sphérique. Ils peuvent être connectés ensemble avec vanne Refrigera spécialement conçue, en utilisant le kit de connection, vendu séparément. Degré de protection IP67

Motores para el control remoto de la apertura/cierre o para la parcialización de la válvula a esfera. Utilizables conjuntamente a las válvulas REFRIGERA expresamente predisuestas, por medio del kit de conexión vendido a parte. grado de protección IP67.

Motores para o controle à distância para a abrir / fechar ou para a parcialização da válvula de esfera. Podem ser utilizados em conjunto com as válvulas Refrigera apropriadamente preparadas, com o kit de conexão vendido separadamente. Grau de proteção IP67.

リモートの開口/閉口コントロール、もしくはボール・バルブのチョーキングに便利な、ロータリー・エレクトリック・アクチュエーター。これらは、特別に製造されたレフリジェラ・バルブと一緒にコネクトすることができます。別売りのコネクティビティ・キットをご使用下さい。保護 "IP67" の程度

Электрические приводы полезно для дистанционного открытия / закрытия, или удушение шарового крана. Они могут быть соединены вместе со специально разработанными клапанами, используя комплект, который продается отдельно. Степень защиты «IP67»

| Code | | | | |
|------------------------|---|---|---|-------------------------------------|
| | | NA-054 100 | NA-094 100 | NA-154 100 |
| Electrical | Nominal Voltage | AC100...240V, 50/60Hz | AC100...240V, 50/60Hz | AC100...240V, 50/60Hz |
| | Power supply range | AC85...265V | AC85...265V | AC85...265V |
| | Power Consumption | 2W at nominal Torque | 20W at nominal Torque | 8W at nominal Torque |
| | | - | - | 4 W |
| | | - | - | 14 VA |
| | Connection | 2Cables 1m, 3 x 0,75mm ² | 2Cables 1m, 3 x 0,75mm ² | 2Cables 1m, 3 x 0,75mm ² |
| | Parallel Connection | - | - | - |
| Functional | Torque (nominal) | 50Nm at nominal V | 90Nm at nominal V | 150Nm at nominal V |
| | Manual Override | Manoeuvring Lever | Manoeuvring Lever | Manoeuvring Lever |
| | Running Time | 8s / 90° | 15s / 90° | 20s / 90° |
| | Noise Level | Max. 45dB (A) without valve | Max. 45dB (A) without valve | Max. 45dB (A) without valve |
| | Position Indicator | Optical indicator | Optical indicator | Optical indicator |
| Safety | Protection Class | Class F | Class F | Class F |
| | Degree of Protection | IP67 in any mounting position | IP67 in any mounting position | IP67 in any mounting position |
| | ATEX | II 2G EEx d IIB T4 | II 2G EEx d IIB T4 | II 2G EEx d IIB T4 |
| | Electro Magnetic Compatibility Directive | CE according to 2004/108/EC | CE according to 2004/108/EC | CE according to 2004/108/EC |
| | Low Voltage Directive | CE according to 2006/95/EC | CE according to 2006/95/EC | CE according to 2006/95/EC |
| | Mode of operation | Type1 (to EN 60730-1) | Type1 (to EN 60730-1) | Type1 (to EN 60730-1) |
| | Rated Impulse Voltage | 4 kV (to EN 60730-1) | 4 kV (to EN 60730-1) | 4 kV (to EN 60730-1) |
| | Control Pollution Degree | 3 (to EN 60730-1) | 3 (to EN 60730-1) | 3 (to EN 60730-1) |
| | Ambient Temp. Range | -20...+70°C | -20...+70°C | -20...+70°C |
| | Media Temperature | -20...+100° | -20...+100° | -20...+100° |
| Non-operating Override | -40°C...+80°C | -40°C...+80°C | -40°C...+80°C | |
| Ambient humidity range | 95% r.H. non condensating (to EN607303-1) | 95% r.H. non condensating (to EN607303-1) | 95% r.H. non condensating (to EN607303-1) | |
| Maintenance | Maintenance Free | Maintenance Free | Maintenance Free | |
| Dimensions | Dimensions(mm) | H=148; L168; W=132 | H=361; L=324; W=307 | H=361; L=324; W=307 |
| Weight | Weight | Approx. 2800g | Approx. 11000g | Approx. 12000g |

Actuators' Selection Charts

Valves operating at the full pressure of the heat pump system require high torque values.

The charts below allow to couple each valve - characterized through inner sphere port diameter - together with the most suitable Electrical Actuator and its ISO5211 Connection Kit.

| BODY VALVE | KIT CODE | □ (mm) | ISO 5211 FLANGE TYPE | BELIMO MOTORS CODE ON/OFF TYPE | BELIMO MOTORS CODE MODULATING TYPE | END-ARMATUREN MOTORS CODE |
|----------------|--------------------|--------|----------------------|---|--|-------------------------------------|
| A, B | REFKIT N-A/B | 9 | F03 | REF-SR230A-R-RFG 20Nm 230v REF-ZSV-09 Internal pin 9x9 | REF-SR24A-R 20Nm 24v REF-ZSV-09 Internal pin 9x9 | - |
| | REFKIT N-A/B SPEC | 14 | F05 | REF-GR230A-R-RFG 40Nm 230v REF-ZGV-14 Internal pin 14x14 | REF-GR24A-R 40Nm 24v REF-ZGV-14 Internal pin 14x14 | - |
| | REFKIT N-A/B SPEC | 14 | F03 | - | - | NA054100 (50Nm) |
| C, D | REFKIT N-C/D | 9 | F03 | REF-SR230A-R-RFG 20Nm 230v REF-ZSV-09 Internal pin 9x9 | REF-SR24A-MF-R 20Nm 24v REF-ZSV-09 Internal pin 9x9 | - |
| | REFKIT N-C/D SPEC | 14 | F05 | REF-GR230A-R-RFG 40Nm 230v REF-ZGV-14 Internal pin 14x14 | REF-GR24A-MF-R 40Nm 24v REF-ZGV-14 Internal pin 14x14 | - |
| | REFKIT N-C/D SPEC | 14 | F03 | - | - | NA054100 (50Nm) |
| E, G | REFKIT N-E/G | 14 | F05-F07 | REF-GR230A-R-RFG 40Nm 230v REF-ZGV-14 Internal pin 14x14 | REF-GR24A-MF-R 40Nm 24v REF-ZGV-14 Internal pin 14x14 | NA054100 (50Nm) |
| | REFKIT N-E/G SPEC | 17 | F05-F07 | - | - | NA094100 (90Nm) |
| F | REFKIT N-F | 14 | F05-F07 | REF-GR230A-R-RFG 40Nm 230v REF-ZGV-14 Internal pin 14x14 | REF-GR24A-MF-R 40Nm 24v REF-ZGV-14 Internal pin 14x14 | NA054100 (50Nm) |
| | REFKIT N-F SPEC | 17 | F05-F07 | - | - | NA094100 (90Nm) |
| H, L, M 2 WAYS | REFKIT N-H/L | 17 | F05-F07 | - | - | NA094100 (90Nm) or NA154100 (150Nm) |
| H, L, M 3 WAYS | REFKIT N-H/L 3 VIE | 17 | F05-F07 | - | - | NA094100 (90Nm) or NA154100 (150Nm) |

| | | | | | | |
|--------------------|-------------------|----|---------|---|--|-----------------|
| J, K DN15, DN20 | REFKIT N-C/D | 9 | F03 | REF-SR230A-R-RFG 20Nm 230v REF-ZSV-09 Internal pin 9x9 | REF-SR24A-R 20Nm 24v REF-ZSV-09 Internal pin 9x9 | - |
| | REFKIT N-C/D SPEC | 14 | F05 | REF-GR230A-R-RFG 40Nm 230v REF-ZGV-14 Internal pin 14x14 | REF-GR24A-R 40Nm 24v REF-ZGV-14 Internal pin 14x14 | - |
| | REFKIT N-C/D SPEC | 14 | F03 | - | - | NA054100 (50Nm) |
| W, X, Y DN25, DN32 | REFKIT N-E/G | 14 | F05-F07 | REF-GR230A-R-RFG 40Nm 230v REF-ZGV-14 Internal pin 14x14 | REF-GR24A-MF-R 40Nm 24v REF-ZGV-14 Internal pin 14x14 | NA054100 (50Nm) |
| | REFKIT N-E/G SPEC | 17 | F05-F07 | - | - | NA094100 (90Nm) |

 Completely made of brass, REFRIGERA fittings have the peculiar value to assure corrosion resistance of all parts.

 Interamente realizzati in ottone, i raccordi REFRIGERA hanno la peculiare caratteristica di garantire l'inalterabilità nel tempo di tutte le parti.

 Die Fittings REFRIGERA sind ganz aus Messing hergestellt und haben als besonderes Merkmal der Sicherstellung die langfristige Haltbarkeit aller Teile.

 Entièrement réalisées en laiton, les raccords Rotalock REFRIGERA ont la caractéristique de maintien de la soupape des éventuels problèmes de corrosion.

 Totalmente realizadas en bronce, los accesorios REFRIGERA tienen la particularidad de garantizar a inalterabilidad en el tiempo de todas las partes.

 Inteiramente produzidas em latão, os acessórios REFRIGERA apresentam uma característica peculiar para assegurar a inalterabilidade de todos os componentes no decorrer do tempo.

 レフリジェラ・フィッティングは耐久性完全にプラスで作られており、提供されるべき、優れた価値を保持します。

 Холодильные фитинги сделаны полностью из латуни, имеет свои особенности для обеспечения неизменности всех компонентов по истечении времени.

Fittings



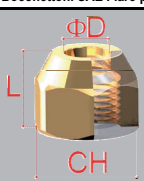

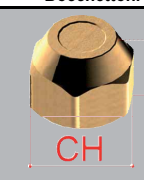
| Bocchettoni SAE Flare per tubi in pollici - SAE Flare nuts (inch tubing) - Bördelmutter für Rohre in Zollen - Raccords SAE Flare pour tuyaux en pouces | | | | | | | |
|--|--------|-----------|-------------|------|------------|------|----|
|  | CODE | SAE FLARE | COPPER TUBE | | DIMENSIONS | | |
| | | | Ø | Ø | ØD | L | CH |
| | | | (in) | (mm) | (mm) | (mm) | |
| | NS4-4 | 1/4" | 1/4" | - | 7 | 15 | 17 |
| | NS4-6 | 3/8" | 3/8" | - | 9,7 | 18,1 | 22 |
| | NS4-8 | 1/2" | 1/2" | - | 13 | 20 | 24 |
| | NS4-10 | 5/8" | 5/8" | - | 16,2 | 21 | 27 |

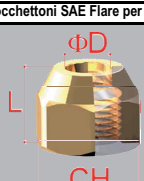
| Bocchettoni SAE Flare ciechi - SAE Flare cap nuts - Blindstutzen Bördel - Raccords SAE Flare borgne | | | | | | | |
|---|---------|-----------|-------------|--------|------------|------|----|
|  | CODE | SAE FLARE | COPPER TUBE | | DIMENSIONS | | |
| | | | Ø | Ø | ØD | L | CH |
| | | | (in) | (mm) | (mm) | (mm) | |
| | N5-4 | 1/4" | Cieco | Cieco | - | 15,5 | 17 |
| | CAP NUT | | Blind | Blind | | | |
| | N5-5 | 5/16" | Blind | Blind | - | 16 | 19 |
| | CAP NUT | | Borgne | Borgne | | | |

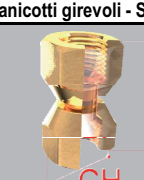
| Bocchettoni SAE Flare per tubi in mm - SAE Flare nuts (metric tubing) - Biirdelmutter für Rohre in Millimetern - Raccords SAE Flare pour tuyaux en mm | | | | | | | |
|---|------------|-----------|-------------|------|------------|------|----|
|  | CODE | SAE FLARE | COPPER TUBE | | DIMENSIONS | | |
| | | | Ø | Ø | ØD | L | CH |
| | | | (in) | (mm) | (mm) | (mm) | |
| | NS4-4/6 | 1/4" | - | 6 | 7 | 15 | 17 |
| | NS4-6/ 10 | 3/8" | | 10 | 10,2 | 19,5 | 22 |
| | NS4-8/ 12 | 1/2" | | 12 | 12,2 | 20 | 24 |
| | NS4-10/ 16 | 5/8" | | 16 | 16,2 | 21 | 27 |

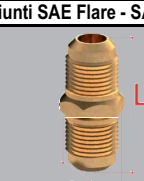
| Manicotti girevoli - SAE Flare twin nuts - Doppelmutter - Manchons Pivotants | | | | | | | |
|---|--------|-----------|-------------|------|------------|------|----|
|  | CODE | SAE FLARE | COPPER TUBE | | DIMENSIONS | | |
| | | | Ø | Ø | ØD | L | CH |
| | | | (in) | (mm) | (mm) | (mm) | |
| | US4-4 | 1/4" | - | - | - | 32 | 17 |
| | US4-6 | 3/8" | | | | 40 | 22 |
| | US4-8 | 1/2" | | | | 46 | 25 |
| | US4-10 | 5/8" | | | | 51 | 28 |

| Giunti SAE Flare - SAE Flare unions - Verbinder - Joints SAE Flare | | | | | | | |
|---|-------|-----------|-------------|------|------------|------|----|
|  | CODE | SAE FLARE | COPPER TUBE | | DIMENSIONS | | |
| | | | Ø | Ø | ØD | L | CH |
| | | | (in) | (mm) | (mm) | (mm) | |
| | U2-4 | 1/4" | - | - | - | 38 | 12 |
| | U2-6 | 3/8" | | | | 44 | 17 |
| | U2-8 | 1/2" | | | | 50 | 20 |
| | U2-10 | 5/8" | | | | 58 | 23 |

| Giunti SAE Flare ridotti - Reducing SAE Flare unions - Reduzierverbinder - Joints SAE Flare réduits | | | | | | | |
|---|---------|-----------|-------------|------|------------|------|----|
|  | CODE | SAE FLARE | COPPER TUBE | | DIMENSIONS | | |
| | | | Ø | Ø | ØD | L | CH |
| | | | (in) | (mm) | (mm) | (mm) | |
| | UR2-64 | 1/4"x3/8" | - | - | - | 38 | 17 |
| | UR2-86 | 3/8"x1/2" | | | | 44 | 20 |
| | UR2-106 | 3/8"x5/8" | | | | 50 | 23 |
| | UR2-108 | 1/2"x5/8" | | | | 58 | 23 |

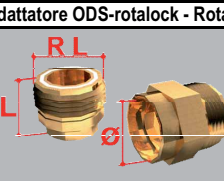
| Adattatore ODS-rotalock - Rotalock to tube-0 adaptor - Rotalock-Verschraubung - Raccord à visser Rotalock | | | | |
|---|-----------------|--------------------|----------------|--------------|
|  | CODE | ROTALOCK (RL) | ODS | DIMENSIONS |
| | | REF50.02.27.012 | 1" - 14UNS | 12 mm - 1/2" |
| | REF50.02.27.016 | 1" - 14UNS | 16 mm - 5/8" | 23 mm |
| | REF50.03.32.022 | 1-1/4" - 12 UNF | 22 mm - 7/8" | 35 mm |
| | REF50.03.32.028 | 1-1/4" - 12 UNF | 28 mm | 35 mm |
| | REF50.04.46.035 | 1-3/4" - 12 UNF 35 | 35 mm - 1-3/8" | 38 mm |
| | REF50.05.60.042 | 2-1/4" - 12 UN | 42 mm | 38 mm |

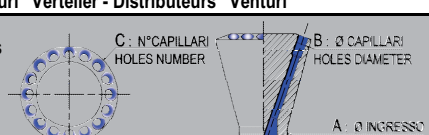
| Distributori tipo "Venturi" - "Venturi"-type Distributors - "Venturi" Verteiler - Distributeurs "Venturi" | |
|---|---|
|  | <p>Ask for a quote for Distributors specifying A, B, C Dimensions and we will suggest you the right choice</p>  <p>C: N°CAPILLARI HOLES NUMBER B: Ø CAPILLARI HOLES DIAMETER A: Ø INGRESSO PASSAGE DIAMETER</p> |

| SAE | THREADING |
|------|------------------|
| 1/4" | 7/16" - 20 UNF |
| 3/8" | 5/8" - 18 UNF |
| 1/2" | 3/4" - 16 UNF |
| 5/8" | 7/8" - 14 UNF |
| 3/4" | 1_1/16" - 14 UNF |
| 7/8" | 1_1/4" - 12 UNF |
| 1" | 1_3/8" - 12 UNF |





 Completely made of brass, REFRIGERA fittings have the peculiar value to assure corrosion resistance of all parts.

 Interamente realizzati in ottone, i raccordi REFRIGERA hanno la peculiare caratteristica di garantire l'inalterabilità nel tempo di tutte le parti.

 Die Fittings REFRIGERA sind ganz aus Messing hergestellt und haben als besonderes Merkmal der Sicherstellung die langfristige Haltbarkeit aller Teile.

 Entièrement réalisées en laiton, les raccords Rotalock REFRIGERA ont la caractéristique de maintien de la soupape des éventuels problèmes de corrosion.

 Totalmente realizadas en bronce, los accesorios REFRIGERA tienen la particularidad de garantizar a inalterabilidad en el tiempo de todas las partes.

 Inteiramente produzidas em latão, os acessórios REFRIGERA apresentam uma característica peculiar para assegurar a inalterabilidade de todos os componentes no decorrer do tempo.

 レフリジェラ・フィッティングは耐久性完全にプラスで作られており、提供されるべき、優れた価値を保持します。

 Холодильные фитинги сделаны полностью из латуни, имеет свои особенности для обеспечения неизменности всех компонентов по истечении времени.

Fittings

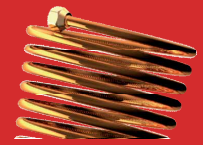

| Tubi capillari - Capillary Tubes - Kapillarrohre - Capillaires pour pressostats | | | | | |
|---|-----------|---|------------|----|--|
| CODE | SAE FLARE | COPPER TUBE | DIMENSIONS | | |
| | | | L(mm) | CH | |
| | NUTS | | | | |
| REF61.05.00.050 | 1/4" | Capillary Tube With Nuts | 500 | 17 | |
| REF61.05.00.100 | 1/4" | | 1000 | 17 | |
| REF61.05.00.150 | 1/4" | | 1500 | 17 | |
| REF61.06.00.150 | 1/4" | Capillary Tube With Nuts and Opener Valve | 1500 | 17 | |

| Valvole di accesso con tubo in rame - Access valve with copper tube - Schraederventil mit Kupferrohr - Valve d'accès avec un tube en cuivre | | | | | |
|---|-----------|--|------------|----|--|
| CODE | SAE FLARE | COPPER TUBE | DIMENSIONS | | |
| | | | L(mm) | CH | |
| | NUTS | | | | |
| REF62.06.00.005 | 1/4" | Schraeder Valve with copper tube D= 6x0,75mm | 50 | 11 | |
| REF62.06.00.010 | 1/4" | | 100 | 11 | |
| REF62.06.00.030 | 1/4" | | 300 | 11 | |

| Sifoni - Siphon - Siphon - Siphon | | | | | |
|-----------------------------------|------|-----|------------|-------|--|
| CODE | ODS | ODM | DIMENSIONS | | |
| | | | L(mm) | H(mm) | |
| | Ø | Ø | | | |
| BM-SIF141030FF | 14,2 | | 293 | 86 | |
| BM-SIF141030 | | 14 | 293 | 86 | |
| BM-SIF161030FF | 16,2 | | 292 | 92 | |
| BM-SIF161030 | | 16 | 292 | 92 | |
| BM-SIF181030FF | 18,2 | | 291 | 122 | |
| BM-SIF181030 | | 18 | 291 | 122 | |
| BM-SIF221030FF | 22,2 | | 289 | 148 | |
| BM-SIF221030 | | 22 | 289 | 148 | |
| BM-SIF281540FF | 28,2 | | 386 | 162 | |
| BM-SIF281540 | | 28 | 386 | 162 | |
| BM-SIF351552FF | 35,2 | | 383 | 185 | |
| BM-SIF351552 | | 35 | 383 | 185 | |
| BM-SIF0421564FF | 42,2 | | 479 | 217 | |
| BM-SIF0421564 | | 42 | 479 | 217 | |
| BM-SIF541581FF | 54,2 | | 573 | 244 | |
| BM-SIF541581 | | 54 | 573 | 244 | |

| Giunti SAE Flare ridotti - Reducing SAE Flare unions - Reduzierverbinder - Joints SAE Flare réduits | | | | | | |
|---|-----------|-------------|------|------------|------|----|
| CODE | SAE FLARE | COPPER TUBE | | DIMENSIONS | | |
| | | Ø | Ø | ØD | L | CH |
| | | (in) | (mm) | (mm) | (mm) | |
| B2-4 | 1/4" | - | - | - | - | - |
| B2-6 | 3/8" | | | | | |
| B2-8 | 1/2" | | | | | |
| B2-10 | 5/8" | | | | | |

| Cappucci in rame - Copper seal caps - Kuplerkappen - Cauchons en cuivre | | | | | | |
|---|-----------|-------------|------|------------|------|----|
| CODE | SAE FLARE | COPPER TUBE | | DIMENSIONS | | |
| | | Ø | Ø | ØD | L | CH |
| | | (in) | (mm) | (mm) | (mm) | |
| B1-4 | 1/4" | - | - | - | - | - |
| B1-6 | 3/8" | | | | | |
| B1-8 | 1/2" | | | | | |
| B1-10 | 5/8" | | | | | |

| Adattatori Flare-ODS con guarnizione in rame - Flare-ODS adapters with copper seal - Loet Adapter mit Kupfer ring - Adapteurs Flare-ODS avec le joint en cuivre | | | | |
|---|-----------------|------|-------------|--|
| CODE | UNF | SAE | ODS | |
| REF64.09.14.006 | 7/16" - 20UNF | 1/4" | 6mm | |
| REF64.09.14.014 | 7/16" - 20UNF | 1/4" | 1/4" | |
| REF64.09.38.006 | 5/8" - 18 UNF | 3/8" | 6mm | |
| REF64.09.38.014 | 5/8" - 18 UNF | 3/8" | 1/4" | |
| REF64.09.38.038 | 5/8" - 18 UNF | 3/8" | 3/8" | |
| REF64.09.38.010 | 5/8" - 18 UNF | 3/8" | 10mm | |
| REF64.09.12.010 | 3/4" - 16 UNF | 1/2" | 10mm | |
| REF64.09.12.012 | 3/4" - 16 UNF | 1/2" | 12mm | |
| REF64.09.12.127 | 3/4" - 16 UNF | 1/2" | 1/2" | |
| REF64.09.58.012 | 7/8" - 14 UNF | 5/8" | 12mm | |
| REF64.09.58.058 | 7/8" - 14 UNF | 5/8" | 16mm - 5/8" | |
| REF64.09.34.018 | 1-1/16" - 14UNS | 3/4" | 18mm | |
| REF64.09.34.034 | 1-1/16" - 14UNS | 3/4" | 3/4" | |
| REF64.09.78.022 | 1-1/4" - 12UNF | 7/8" | 22mm - 7/8" | |

GENERAL TERMS OF SALES

1. PRODUCTS

The products object to the Terms of Sales can be found whether in the Refrigerera Catalogue or in the commercial offers inside it along with the designs and specifications. Specifications such as material, weight, size, capacity, services and other information contained in the catalogue are supplied just as information for the BUYER and they will not be considered compulsory for Refrigerera Industriale srl. The catalogue does not represent an offer for sale and Refrigerera Industriale srl exercises the right to change them at its discretion at any time without notice or cease producing or commercializing any product. Such variations, included replacement of material with others reasonably similar, will not be accepted as an objection on the part of the BUYER. The BUYER declares to have had express knowledge of the aforementioned catalogue or as an alternative of the commercial offer enclosed.

2. PRICES AND TERMS OF PAYMENT

The prices are ex-works of Refrigerera Industriale srl unless a different covenant which has to be expressly stated in the commercial offer or in the purchase order. Duties, taxes and charges are expected to be paid by the BUYER. The possible advance payments on the sales prices are always unproductive and serve to bind the BUYER. The payments are always net at the Seller's address. Therefore, it creates neither a case or innovation of the original loan or damage to the agreement of personal property or change of the disregarded territorial jurisdiction. Delayed payments run, from the expiry date, with full rights and without pledging any delay, the corresponding interests to the bank rate of the European Central Bank plus 5,0%. Failure to comply the payment terms or any other contract conditions on the part of the BUYER, entitles Refrigerera Industriale srl to suspend or delay the exercise of its contractual obligations or rescind the contract with simple notice. The contract resolution involves damage compensation. Refrigerera Industriale srl is authorized to retain advance payment as penalty in case the BUYER overturns the order.

3. OFFERS AND ORDERS

Refrigerera Industriale srl is bound to the offer for 30 days from the day of the shipment. Refrigerera Industriale srl reserves the right to accept or refuse the orders. The BUYER's orders must be addressed in writing or by fax and they will remain irrevocable for the BUYER after two days of the shipment. The orders placed by phone should be subsequently regularized by the BUYER in writing within two days. Such orders or any other supply condition regarding them, are accepted only if they are confirmed in writing by Refrigerera Industriale srl. If the confirmation contains changes or additions to the order, the contract is concluded unless waived in writing by the BUYER within four days from the day of the confirmation of the shipment. In case the order is rejected, Refrigerera Industriale srl agrees to communicate the BUYER in writing within two days from the day of the placement of the order and possible advance payments (see "Prices and Terms of Payment") will be reimbursed to the BUYER.

4. DELIVERY

Delivery time runs from the moment the contract is considered concluded and, if necessary, from the moment the elements of the contract are supplied and Refrigerera Industriale srl is provided with the necessary information and the BUYER has duly paid for the maturities. In all cases, the term of delivery is computed in working days and with reason, adequately extended due to events beyond the control of Refrigerera Industriale srl, such as strikes, lock-outs, fire, flood, late delivery of parts from suppliers, engine failure or other unforeseen circumstances. A delayed readiness of accessory parts that does not prevent the use of the related manufacture product. Partial delivery is always admitted. The delivery is intended to be carried out in any case on the business premises of Refrigerera Industriale srl upon submission of a notice or failing that, upon remission to the Carrier. This even when, for express derogation, the price includes freight. From this moment onwards all the risks on the goods are transferred to the BUYER, and will also be at buyer's risk the charges of unloading, storage and safe keeping, maintenance and insurance. If the BUYER does not remove the goods at the date established in the order, the order will be cancelled after three months of such date.

5. PACKAGING AND SHIPPING

The packing is at the BUYER's expense and it is invoiced at cost price. Deliverables travel at the BUYER's risk even if it was sold free delivered. The insurance is carried out under strict directions of the BUYER and in any case at his expense.

6. WARRANTY

Standard 12-month warranty

Refrigerera Industriale s.r.l. (hereafter the Seller) undertakes to replace or repair, at its option, any goods supplied by the Seller if a defect in material or workmanship arises under conditions of normal and proper use and maintenance (fair wear and tear excepted), provided that all of the following are true:

The goods were operated and maintained in accordance with the Seller's operating instructions.

- a. The claim is first notified promptly in writing to the Seller.
- b. The defect occurs within 12 months from the date of Take-Over of the goods by the Buyer.
- c. The goods have not been repaired or modified by anyone other than the Seller or at the Seller's direction.
- d. In the case of goods not of its own manufacture, the Seller's responsibility shall be limited to the passing on to the Buyer the benefit of any guarantee or warranty given to the Seller by the manufacturer of such goods.

Bespoke goods

Where the Seller has manufactured goods to the design of, or furnished by, the Buyer, the Seller accepts no liability for design errors or the consequences thereof, and the Buyer shall indemnify the Seller against all demands, damages, costs, and expenses arising in connection with such design.

The Seller disclaims all other warranties - whether express or implied, oral or written - with respect to the goods, including without limitation all warranties of merchantability or fitness for any purpose. The Seller does not warrant that the goods are error-free or will accomplish any particular results.

The foregoing states the entire liability in contract and in tort of the Seller in respect of defective goods and the Seller shall not, save as expressly provided herein, be liable for any other claim in regard to defects in the goods.

7. CLAIMS

The BUYER will inspect the products immediately and with accuracy and attention at the moment of the arrival on their own office and communicate at once to Refrigerera Industriale srl any shortage, fault or informality. Any damages of transport must be written on the carrier receipt. The notification on the part of the BUYER about the shortage, faults or non conformity of the products must be done in writing and must contain a complete description of the faults, shortage or non compliance, specifying the shipping documents corresponding to the products and the parcels under dispute. After eight (8) days from the product's arrival date on the premises of the BUYER without notifying the shortage or non compliance with the products, these will be considered as definitively accepted from the BUYER. The BUYER will not be able, in any case, suspend or delay the payments, not even in case of objection, claim or controversy.

8. TITLE RETENTION AGREEMENT

According to the possible extended payment envisaged hereby, the BUYER explicitly declares to accept the retention of title on everything object to the present commission, in favour of Refrigerera Industriale srl pursuant to and by effect of the articles 1523, 1524 and the followings of the Civil Code. And so, until the BUYER has fully paid, in legal currency, the agreed price, the goods object to the delivery remain property of Refrigerera Industriale srl. In case of cancellation of the order/s, Refrigerera Industriale srl can take possession of the goods wherever they are, even united or incorporated in property of the BUYER or a third party, and not being valid for him the legal regime of ownership or property for destination or incorporation, not even by expressed covenant. During the aforementioned period, the BUYER assumes the obligations and responsibility of depository for the goods delivered, and commits to guard and insure against any damage, destruction, loss, etc. The BUYER cannot alienate the goods which are the object hereunder until they are balanced in legal currency, because until such circumstance, they are Refrigerera Industriale srl's property. In default of payment, even only one, the BUYER is prevented from the benefit of validity and Refrigerera Industriale srl can ask for the restitution of the deliveries seizing as indemnity the payments already done, except the faculty of claiming the damages suffered. In case of cancellation of the order/s before the delivery due to breach on the part of the BUYER, the possible proportion deposited when ordering is due to the supplier as a penalty in conformity with the art. 1382 of the Civil Code.

9. VALID LAW AND COMPETENT JURISDICTION

The sales under the present conditions are regulated by the Italian Law. In case of controversy the competent jurisdiction is the one in Pordenone.



CONDIZIONI GENERALI DI VENDITA

1. PRODOTTI

I prodotti oggetto delle condizioni commerciali sono quelli indicati nel catalogo Refrigera o nelle offerte commerciali della stessa, con le specifiche ed i disegni ivi contenuti. Specifiche quali descrizione di materiale, peso, dimensioni, capacità, prestazioni ed altri dati contenuti nel catalogo sono fornite a titolo di informazione per la AZIENDA ACQUIRENTE e non verranno considerate vincolanti per Refrigera Industriale srl. Il catalogo Refrigera non costituisce offerta di vendita e la Refrigera Industriale srl si riserva il diritto di variare a propria discrezione in qualsiasi momento senza preavviso tali specifiche o di cessare di fabbricare e/o commercializzare qualsiasi prodotto, e talvariazioni, comprese la sostituzione di materiali con altri ragionevolmente simili, non potrà dare luogo a contestazioni da parte della AZIENDA ACQUIRENTE. La AZIENDA ACQUIRENTE dichiara di avere avuto specifica conoscenza del catalogo suddetto od in alternativa dell'offerta commerciale acclusa.

2. PREZZI E CONDIZIONI DI PAGAMENTO

I prezzi si intendono franco stabilimento della Refrigera Industriale srl salvo diversa pattuizione che deve essere espressamente riportata nell'offerta commerciale o nell'ordine di acquisto. Tasse, imposte e spese sono a carico della AZIENDA ACQUIRENTE. Gli eventuali anticipi sui prezzi di vendita sono sempre infruttiferi e servono a vincolare la AZIENDA ACQUIRENTE. I pagamenti si intendono sempre netti al domicilio del Venditore. Ciò non produce però in alcun caso né novazione del credito originale, né pregiudizio alcuno al patto di riservata proprietà, né mutamento nella derogata competenza territoriale. Sui ritardati pagamenti decorrono, dalla data della scadenza, di pieno diritto e senza alcuna costituzione di mora, gli interessi al tasso ufficiale di sconto della Banca Centrale Europea maggiorato di 5,0%.

L'inosservanza da parte della AZIENDA ACQUIRENTE delle condizioni di pagamento o di qualsiasi altra condizione contrattuale, dà alla Refrigera Industriale srl il diritto di sospendere o rinviare l'esecuzione dei suoi obblighi contrattuali, oppure di risolvere il contratto con semplice comunicazione. La risoluzione del contratto comporta la rivalsa dei danni. La Refrigera Industriale srl è autorizzata a trattarsi gli anticipi a titolo di penale nel caso in cui la AZIENDA ACQUIRENTE revochi l'ordine.

3. OFFERTE E ORDINI

La Refrigera Industriale srl è vincolata all'offerta per la durata di 30 giorni dalla data di invio della stessa. La Refrigera Industriale srl si riserva la facoltà di accettare o meno gli ordini. Gli ordini della AZIENDA ACQUIRENTE dovranno redigersi per iscritto, anche a mezzo fax e rimarranno irrevocabili per la AZIENDA ACQUIRENTE dopo due giorni dalla spedizione. Gli ordini telefonici dovranno essere successivamente regolarizzati da parte della AZIENDA ACQUIRENTE per iscritto entro due giorni. Detti ordini o qualsiasi altra condizione di fornitura che ad essi si riferiscano, si intendono accettati solo se confermati per iscritto da parte della Refrigera Industriale srl. Se la conferma contiene modifiche o aggiunte all'ordine, il contratto si intende concluso ove la AZIENDA ACQUIRENTE non abbia manifestato per iscritto il suo dissenso o rifiuto entro quattro giorni dalla data di spedizione della conferma. In caso di rifiuto del ordine, la Refrigera Industriale srl s'impegna ad informare la AZIENDA ACQUIRENTE per iscritto, entro due giorni dalla data di ricevimento dell'ordine ed eventuali anticipi (vedi "Prezzi e condizioni di pagamento") verranno rimborsati alla AZIENDA ACQUIRENTE.

4. CONSEGNE

Il termine di consegna decorre dal momento in cui il contratto si ritiene concluso e, occorrendo, dal momento in cui sono stati forniti e definiti gli elementi del contratto e notificati alla Refrigera Industriale srl i dati occorrenti al presente, sempre che la AZIENDA ACQUIRENTE abbia effettuato puntualmente il pagamento delle scadenze. In tutti i casi, il termine di consegna viene computato in giorni lavorativi e viene di diritto, adeguatamente prorogato per effetto di avvenimenti non imputabili alla Refrigera Industriale srl, quali scioperi, serrate, incendi, inondazioni, ritardate consegne da parte dei fornitori, mancanza di forza motrice od altre cause di forza maggiore. Non costituisce inosservanza del termine un differito approntamento di parti accessorie che non impedisca l'impiego del relativo manufatto. Sono sempre ammesse consegne parziali. La consegna si intende sempre eseguita ad ogni effetto, negli stabilimenti della Refrigera Industriale srl all'atto della notifica d'approntamento, o in difetto di tale notifica, all'atto della remissione al Vettore: ciò anche quando, per espressa deroga, il prezzo comprende le spese di trasporto. Da tale momento tutti i rischi sulla merce si trasferiscono alla AZIENDA ACQUIRENTE, e sono a suo carico anche le spese di scarico dai mezzi di trasporto, di magazzino, e custodia, manutenzione ed assicurazione. Se la AZIENDA ACQUIRENTE non ritira la merce alla data stabilita nell'ordine, passati tre mesi da tale data, l'ordine si intenderà nullo di diritto per fatto della AZIENDA ACQUIRENTE, anche senza avviso alla stessa da parte della Refrigera Industriale srl, e qualora la AZIENDA ACQUIRENTE intendesse avere la merce, ciò dovrà essere oggetto di nuovo ordine.

5. IMBALLO E TRASPORTO

L'imballo è a carico della AZIENDA ACQUIRENTE e viene fatturato al costo. La merce viaggia a rischio e pericolo della AZIENDA ACQUIRENTE anche se venduta franco destino. L'assicurazione viene effettuata solo su precisa istruzione della AZIENDA ACQUIRENTE ed è in ogni caso a carico della stessa.

6. GARANZIA

La Refrigera Industriale srl garantisce la buona costruzione e la buona qualità di quanto è oggetto della fornitura, nel senso che si impegna a riparare od a fornire ex novo, a suo insindacabile giudizio, gratuitamente, nel più breve tempo possibile, quelle parti che, entro il periodo di garanzia, presentassero riconosciuti difetti di materiali o di costruzione o di lavorazione che le rendessero inidonee all'uso cui sono destinate, ciò senza essere tenuto al risarcimento di danni diretti od indiretti di qualsiasi natura e per qualsiasi ragione. La garanzia è di sei mesi per particolari o trasmissioni riparate, e di 12 mesi per particolari o trasmissioni nuove. Le parti da riparare o da fornire ex novo debbono essere ritornate allo stabilimento della Refrigera Industriale srl a cura, spese e rischio della AZIENDA ACQUIRENTE, quelle riparate o fornite ex novo sono consegnate franco stabilimento della AZIENDA ACQUIRENTE. Le parti sostituite restano di proprietà della Refrigera Industriale srl. Le spese per lo smontaggio ed il montaggio delle parti da riparare o fornire a nuovo sono a carico della AZIENDA ACQUIRENTE. Il diritto di garanzia della AZIENDA ACQUIRENTE decade se non osserva, anche per una sola volta, le condizioni di pagamento, e se i guasti lamentati risultano originati da fatti della AZIENDA ACQUIRENTE stessa, suoi dipendenti o terzi, quali cattiva installazione, imperizia nella condotta di quanto è oggetto della fornitura, errato o anormale uso, sovraccarico, cattiva o difettosa manutenzione, impiego di combustibili, lubrificanti inadatti, riparazioni, sostituzioni, modifiche o comunque manomissioni eseguite o fatte eseguire dalla AZIENDA ACQUIRENTE, senza autorizzazione della Refrigera Industriale srl, nonché da cause di forza maggiore. Rimangono escluse dalla garanzia tutte quelle parti che per la loro natura od uso sono soggette a normale logorio od inevitabile deterioramento. Per quelle parti della fornitura che la Refrigera Industriale srl abbia acquistato da altre Ditte vigono, nei confronti della AZIENDA ACQUIRENTE, esclusivamente le eventuali garanzie stabilite da tali Ditte. Vizi e difetti devono essere denunciati al Venditore per iscritto nei termini di legge. Restano esclusi dalla garanzia danni provocati a terzi, siano essi persone o cose, dall'utilizzo o danni avuti per mancato freddo e mancato profitto derivante dall'arresto di linee produttive.

7. RECLAMI

La AZIENDA ACQUIRENTE esaminerà i prodotti immediatamente e con la dovuta diligenza ed attenzione al momento del loro arrivo presso la propria sede e comunicherà senza ritardo alla Refrigera Industriale srl qualsiasi mancanza, difetto o non conformità. Eventuali danni di trasporto devono essere annotati sulla ricevuta del trasportatore. La comunicazione da parte della AZIENDA ACQUIRENTE della mancanza, difettosità o non conformità dei prodotti dovrà essere effettuata per iscritto e dovrà contenere una descrizione completa dei difetti, delle mancanze o delle non conformità, la menzione dei documenti di spedizione relativi ai prodotti e contrassegni dei colli contestati. Trascorsi 8 giorni dalla data di arrivo dei prodotti presso la sede del Compratore senza che lo stesso abbia contestato la mancanza o la non conformità dei prodotti, questi verranno considerati come definitivamente accettati dalla AZIENDA ACQUIRENTE. La AZIENDA ACQUIRENTE non potrà in nessun caso sospendere o ritardare i pagamenti, neppure in caso di contestazione, reclamo o controversia.

8. PATTO DI RISERVATO DOMINIO

In relazione all'eventuale pagamento dilazionato previsto dal presente, la AZIENDA ACQUIRENTE dichiara esplicitamente di accettare la riserva di proprietà su tutte le cose oggetto della presente commissione, a favore della Refrigera Industriale srl ai sensi e per gli effetti degli articoli 1523, 1524 e seguenti del Codice Civile. E così, sino a che la AZIENDA ACQUIRENTE non abbia pagato integralmente, in valuta legale, il prezzo pattuito, i beni oggetto della fornitura rimangono di proprietà della Refrigera Industriale srl. In caso di risoluzione dell'ordine o degli ordini, la Refrigera Industriale srl può riprendere possesso dei beni ovunque essi si trovino, ancorché uniti od incorporati in beni di proprietà della AZIENDA ACQUIRENTE o di terzi, non valendo per la medesima il regime legale delle pertinenze o degli immobili per destinazione o incorporazione, anche per espressa pattuizione. Durante suddetto periodo, la AZIENDA ACQUIRENTE assume gli obblighi e la responsabilità di depositaria per i beni forniti, e si impegna a custodirli ed assicurarli contro qualsiasi danneggiamento, distruzione, perdita, ecc. La AZIENDA ACQUIRENTE non può alienare i beni oggetto del presente sino al saldo in valuta legale di essi, perché sino a tale circostanza, sono di proprietà della Refrigera Industriale srl. In caso di mancato pagamento, di un solo pagamento, la AZIENDA ACQUIRENTE decade dal beneficio del termine e la Refrigera Industriale srl può richiedere la restituzione delle cose vendute incamerando a titolo di indennità i pagamenti già incassati, salvo le facoltà di richiedere eventualmente i danni subiti. In caso di risoluzione dell'ordine o degli ordini prima della consegna per inadempimento della AZIENDA ACQUIRENTE, l'eventuale quota versata all'atto dell'ordinazione viene riconosciuta dovuta alla casa fornitrice quale penale ai sensi art. 1382 Codice Civile.

9. LEGGE VALIDA E FORO DI COMPETENZA

Le vendite sottoposte alle presenti condizioni sono regolate dal diritto italiano. Per qualsiasi controversia il foro competente è quello di **Pordenone**.

RoHS and WEEE Compliance Statement.

2011/65/EU Directive.

On January 27, 2003 the European Parliament and the Council of the European Union authorized Directive 2002/95/EC on the restriction of the use of certain hazardous substances in electrical and electronic equipment. This new Directive, also referred to as RoHS ("ro-has") requires that manufacturers reduce usage of six hazardous substances to minimum acceptable levels.



This Directive will ban the placing on the EU market of new electrical and electronic equipment containing more than agreed levels of Lead (Pb), Cadmium (Cd), Mercury (Hg), Hexavalent chromium (Cr +6), Polybrominated biphenyl (PBB) and Polybrominated diphenyl ether (PBDE) flame retardants (art.4). On the same date, Directive 2002/96/EC or WEEE (waste electrical and electronic equipment) was authorized. This Directive encourages and sets specific criteria for the collection, handling and recycling of electric and electronic waste in particular (art.10):

Sets requirements for the amount of WEEE collection (separate from households)

Holds resellers accountable for providing WEEE returns, free of charge. Requires WEEE to be treated

Requires manufacturers to mark EEE products with the WEEE symbol (trash can with "X")

Both Directives impact the entire electronics industry at every level, from the retail store, to manufacturers, distributors and OEMs, but restrictions shall not apply to applications listed in annex 2 and in particular for HVAC manufacturers:

A2.6 Lead as an alloying element in steel containing up to 0,35% lead by weight, aluminium containing up to 0,4% lead by weight and as a copper alloy containing up to 4% lead by weight.

A2.9 Hexavalent chromium as anticorrosion of the carbon steel cooling system in absorption refrigerators.

In any case our strategy to support these environmentally important initiatives include:

- 90% of all Refrigerera Industriale srl packing materials are already recyclable
- Refrigerera Industriale SRL products have not included the intentional use of Cd, Hg, PBB, PBDE since 2003.
- Lead in copper alloys products is present within the accepted RoHS limits.
- Hexavalent Chromium in yellow zinc plating treatment not exceeds 0,003% by weight.

REACH Compliance Statement.

1907/2006/EC Regulation.

The European Regulation 1907/2006/EC concerning the Registration, Evaluation, Authorization and Restrictions of Chemicals, the so called REACH Regulation, was published on GUCE L136 dated 29 May 2007 and came into force in the European Union on the 1st June 2007.

This Regulation requires to pre-register and register chemical substances produced or imported into Europe at the European Agency for Chemicals (ECHA).

Refrigerera Industriale srl is not a "manufacturer" or an "importer" of *substances* and so the company has not the obligation to pre-register and/or register.

Refrigerera Industriale srl is not a "manufacturer" or an "importer" of *preparations* and so the company has not to give to its customers either information about registrations of the contained substances or information about safety.

Refrigerera Industriale srl is not a "manufacturer" or an "importer" of *articles* that have substances intended to be realised during normal and reasonable foreseeable conditions of use (Art. 7.1 of REACH) and so the company has not the obligation to pre-register and/or register these substances.

For its suppliers, Refrigerera Industriale srl is a "downstream users" of *substances, preparations and articles*, used in its own manufacturing processes and in its own products.

Together with its suppliers of substances/preparations and articles, Refrigerera Industriale srl is constantly engaged to verify that:

- they well know the contents and the aims of REACH Regulation
- they are working to fulfil the obligations pertaining to them, foreseen by the Regulation
- they guarantee us smooth continuity of their supplies also in the future

For its customers, Refrigerera Industriale srl is a "manufacturer" of articles and in this rule our company is constantly engaged to verify that in its products:

- the restricted substances listed in Annex XVII are not used in a manner not conform to restrictions, in compliance with to Art. 67 of REACH
- the SVHC, *Substances of Very High Concern*, listed in the Candidate List of Annex XIV; are not present in the articles we supply you in more **than 0,1% mass/mass** (the 0,1% threshold relates to the total weight of the articles) and simultaneously satisfied all the conditions listed in Art. 7.2 of REACH. If this case happens our company binds itself to communicate it in time to its own customers, ensuring sufficient information to safety use, according to Art. 33 of REACH.

Warranty conditions of Refrigerera Industriale S.r.l.

We certify that our products are made with high-quality copper for refrigeration piping, and they are perfectly cleaned after production. The use of these accessories will be made under the complete own responsibility of the owner or the installer, and our warranty does not concern any damages to the air-conditioners, or to the end users of them.

Condizioni di garanzia di Refrigerera Industriale S.r.l.

Garantiamo che i nostri prodotti sono fabbricati con rame di alta qualità per circuiti frigoriferi, e sono perfettamente lavati e ripuliti dopo la produzione.

L'utilizzo dei nostri accessori in impianti frigoriferi avviene sotto l'esclusiva e totale responsabilità dell'utilizzatore o installatore degli stessi; la nostra garanzia non riguarda in alcun caso eventuali danni agli impianti frigoriferi in cui sono utilizzati, né ai loro utilizzatori.

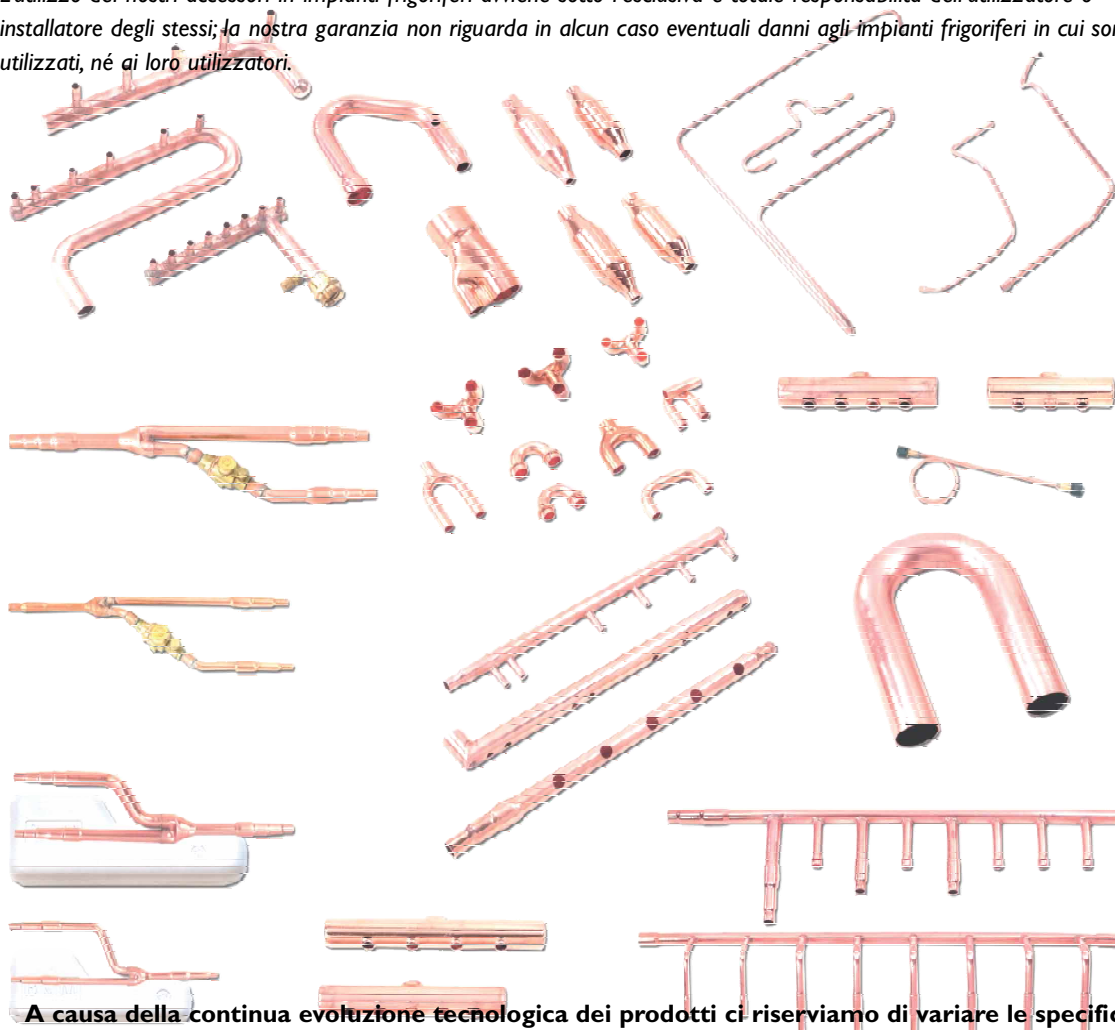

**A causa della continua evoluzione tecnologica dei prodotti ci riserviamo di variare le specifiche tecniche in qualsiasi momento senza dare preavviso.
Due to the constant technological evolution of the products, we reserve the right to alter the technical specifications at any given time without prior notice.**

Ask for the Air Conditioning products Catalogue

Richiedete il catalogo completo dei prodotti per il condizionamento

www.refrigerera.eu

For discount on price list please contact our export office at:

info@refrigerera.eu

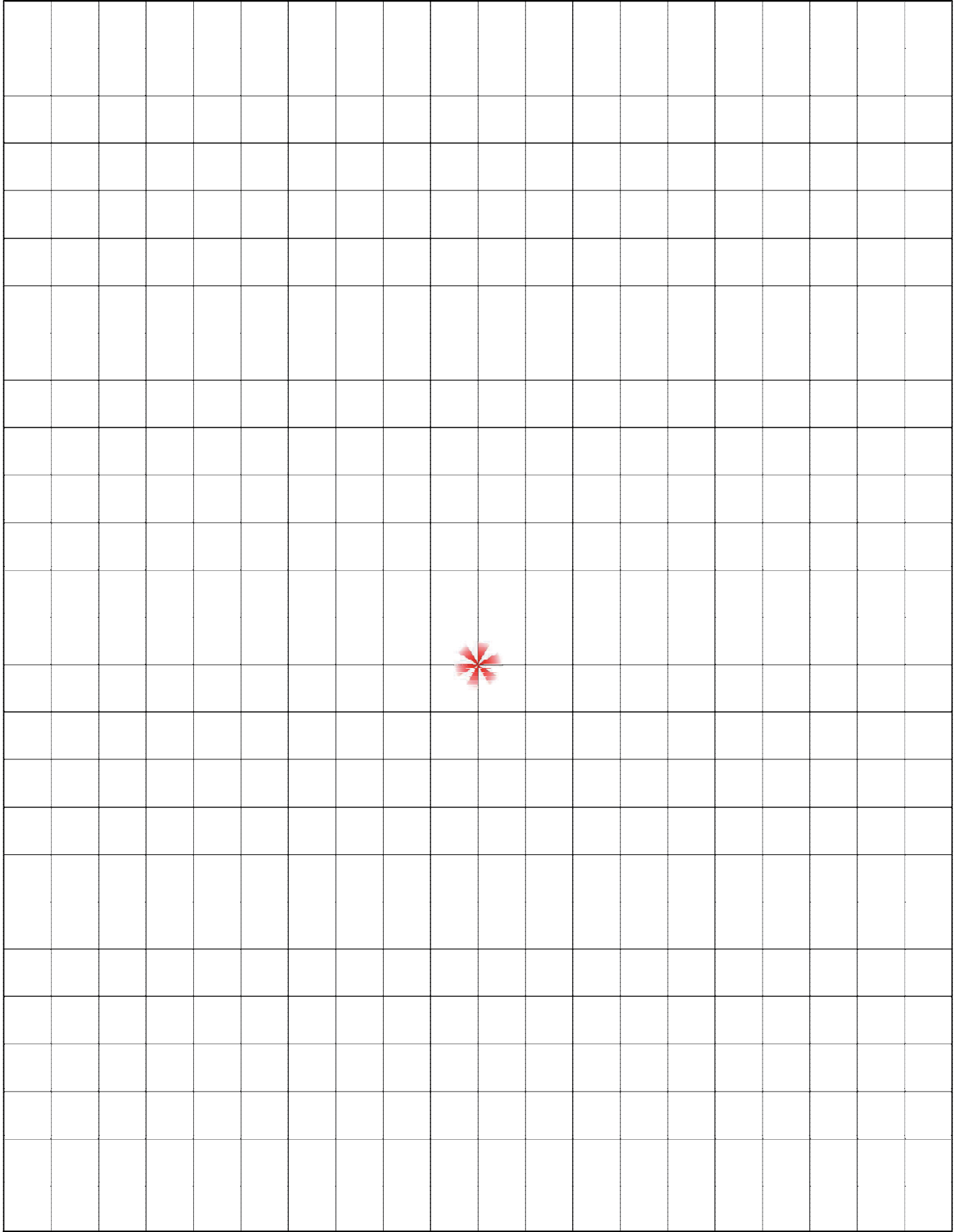



Refrigera Industriale Srl

Head Office Refrigeration and Manufacturing
Via Chiavornicco, 76 - 33084 Cordenons (Pordenone) - Italy
Tel. +39 0434 542266 / Fax +39 0434 542267
P.I./VAT nr IT01743590935

Head Office Air-Conditioning:
Viale J. F. Kennedy, 150-152 - 10040 Leini (Torino) - Italy
Tel. +39 011 9969790 / Fax +39 011 9915200

info@refrigera.eu
www.refrigera.eu

